

# DenseLight

SEMICONDUCTORS

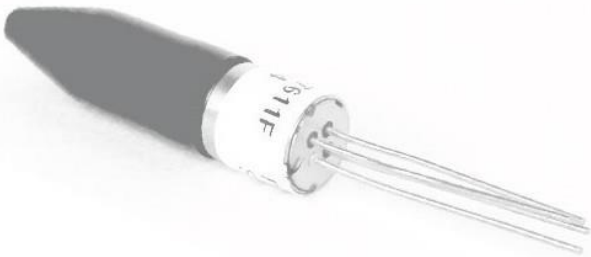

## Enabling Integrated Photonic Solutions

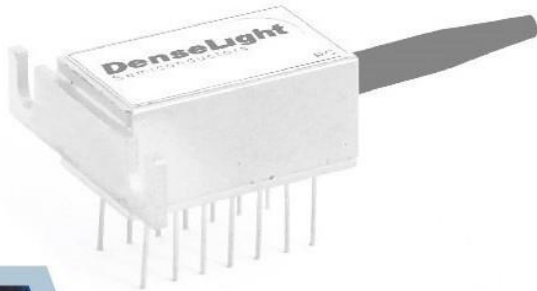

## The DenseLight Advantage



### *Innovative Products*

DenseLight makes use of cutting edge optical and photonics technology to design and manufacture SLEDs and other laser products. These products are key components in diverse applications that will pave the way to revolutionising the technology of the future: self-driving cars, quantum optics, structural health monitoring, renewable energy harvesting, optical test and measurement solutions.

### *Comprehensive In-house Capabilities*

DenseLight brings together state-of-the-art photonics technology and a highly qualified, experienced team in its 50,000-square-foot purpose-built headquarters that houses R&D, product design and manufacturing.

DenseLight's ability to produce prototypes of customised photonics devices and arrays also allows customers to outsource the photonics supply chain to DenseLight.



### *Commitment to Quality*

Denselight was awarded the ISO 9001:2015 certification in January 2018



## Applications – Points of Use

Application	Product family	Formm Factor	Product Code	Specification
Navigation (e.g. FOG)	SLED	14-pin BTF	DL -CS5103A DL -CS5153A DL -CS5203A	Typ. WL 1550 nm Typ. FWHM 40 nm Min. Power 10, 15, 20, 35 mW SMF/PMF
		8-pin BTF	DL-CS50L4C DL-CS55057C	Typ WL 1550 nm Typ FWHM 40, 60 nm Min Power 1, 5 mW
Fiber Optic Test and Measurement (e.g. Broadband Light Source, OTDR, Optical Channel Monitoring, Metrology-vibration measurement, Distance Measurement, etc.)	SLED	14-pin BTF	DL-CS3089A DL-CS3159A	Typ. WL 1310 nm Typ. FWHM 75, 83 nm Min. Power 8, 15 mW
		14-pin BTF	DL-CS43H4A	Typ. WL 1430 nm Typ. FWHM 45 nm Min. Power 15 mW
		14-pin BTF	DL-CS5169A	Typ. WL 1550 nm Typ. FWHM 80, 100 nm Min. Power 16, 10 mW
		14-pin BTF	DL-CS51010A	Typ. WL 1550 nm Typ. FWHM 80, 100 nm Min. Power 16, 10 mW
	ELED	14-pin DIL	DL-CS5029L	Typ. WL 1510 nm Typ. FWHM 100 nm Min. Power 0.2 mW
		TO-56 Aspherical Lens	DL-US5084D	Typ. WL 1550 nm Typ. FWHM 40 nm Min. Power 0.8 mW
		TO-56 Coaxial	DL-US31014D-FS	Typ. WL 1310 nm Typ. FWHM 40 nm Min. Power 0.15 mW
Data Communications	ELED	TO-56 Flat Lens	DL-US3104H	Typ. WL 1310 nm Typ. FWHM 40 nm Min. Power 1 mW
Metrology	SLED	14-pin BTF	DL-CS3024A DL-CS3089A DL-CS3159A	Typ. WL 1310 nm Typ. FWHM 40, 75, 83 nm Min. Power 2, 8, 15 mW
Distributed Fiber Optic Sensing (e.g. Distributed Acoustic Sensing, Perimeter Intrusion Detection, etc.)	ASE Series	ILM	DL-ASE-CW-CSC5169A	WL 1510 - 1590 nm DOP < 5% Power Density > -25 dBm/0.1 nm
	BP1 Series	ILM	DL-BP1-CS5169A	Typ. WL 1550 nm Typ. FWHM 80 nm Min. Power 12 mW (with circulator)
	BF Series	ILM	DL-BFx-CLS101B-S1550	WL 1550 nm, Min. Power 10 mW, Linewidth <50, <200 kHz



## Applications – Points of Use

Application	Product family	Formm Factor	Product Code	Specification
Gas sensing (e.g. Methane)	DFB	TO	DL-DFB65303T	WL 1653.7 nm, Min. Power 3 mW, SMSR >35 dB
		Chip	DL-DFB65304D DL-DFB65306D	WL 1653.7 nm, Min. Power 4mW, 6mW, SMSR >35 dB
Sensing (e.g. LiDAR, Wind Lidar, Current, Spectrometry, etc.)	FBGL	14-pin BTF	DL-CLS101B-FP-S1550	WL 1550 nm, Min. Power 10 mW, Linewidth <100, <200 kHz SMSR >45 dB
	BF Series	ILM	DL-BFx-CLS101B-S1550	WL 1550 nm, Min. Power 10 mW, Linewidth <50, <200 kHz
Structural Health Monitoring	SLED	14-pin BTF	DL -CS5103A DL -CS5153A DL -CS5203A	Typ. WL 1550 nm Typ. FWHM 40 nm Min. Power 10, 15, 20, 35 mW SMF/PMF
			DL-CS5169A	Typ. WL 1550 nm Typ. FWHM 80, 100 nm Min. Power 16, 10 mW
	BF Series	ILM	DL-BFx-CLS101B-S1550	WL 1550 nm, Min. Power 10 mW, Linewidth <50, <200 kHz
Medical (e.g. OCT, Blood glucose)	FP	TO	DL-FPL65110T-A	Typ. WL 1650 nm Op Temp 0C-60C Min. Power 50 mW pulsed Typ. SE 0.09 mW/A@25C
	SLED	14-pin BTF	DL-CS68M5A	Typ. WL 1680 nm Typ. BW FWHM 50 nm Min. Power 15 mW Typ. Spectral Ripple 0.3 dB



## All-Semiconductor ASE Broadband Light Source

DenseLight DL-ASE is a series of all-semiconductor low DOP ASE optical sources with a wide selection of wavelengths, covering the entire telecom spectral bands (from O to U). The CW output standard model comes with excellent stability in output power and spectrum. As it operates on direct light generation from superluminescent principle (SLED), it can be directly intensity modulated. Modulation models are available upon request, as well as custom models to meet your specific needs.

- **Low-DOP capability <5%**
- **High optical power up to 19dBm**
- **Consistent spectral power density across wide bandwidth (up to 120nm)**
- **Excellent power stability <0.01dB**
- **Analog modulation (3dB~20MHz)**
- **Digital modulation (tr<1ns)**

**ASE (IM)**

**ASE (CW)**

### APPLICATIONS

- *OCT, non invasive analysis*
- *SHM – sensing in gas & oil*
- *FOS*
- *T&M*
- *Communications*
- *Defense & Security*

### PRODUCT DESCRIPTION

#### DL-ASE-CW Series

- Over temperature protection and internal PCB temperature monitor
- Active-Low optical power enabled function
- Extendable Operating temperature up to 70 °C
- Optical Output - SMF Fiber Pigtail Output

#### DL-ASE-IM Series

- Over temperature protection and internal PCB temperature monitor
- Pre-bias optical power
- Analog intensity modulation up to 20MHz
- Pulse or digital modulation up to 200MHz
- Optical Output – FC Receptacle

### FEATURES & PERFORMANCE

- Wide spectral coverage, 1200nm-1700nm
- Customized ASE design and spectrum combination (e.g. return sensing signal port, monitoring optical coupler, etc.)
- **CW operation (DL-ASE-CW-Series) or Direct-modulation operation (DL-ASE-IM-Series)**
- Fiber pigtail or FC receptacle output
- Improved reliability by integrated optical isolator
- Remote optical power enabled function by active-low logic
- Standard operating temperature: 0°C to 65°C. Extended range -20°C to 70°C
- Telcordia certification, RoHS Compliance

## APPLICATIONS

<b>Medical Technology</b>	<ul style="list-style-type: none"> <li>OCT (biopsies-less medical cell imaging, diagnostic imaging), point of use/ handhelds/ non-invasive diagnosis (blood analysis)</li> </ul>
<b>Structure Health Monitoring (SHM)</b>	<ul style="list-style-type: none"> <li>sensing in gas &amp; oil production, telemetry in electricity distribution (FOS)</li> <li>physical (temp, pressure, strain, vibrations), structural and civil engineering, smart structures, intelligent distributed sensing (DTS &amp; DTSS)</li> </ul>
<b>Test &amp; Measurement</b>	<ul style="list-style-type: none"> <li>in-line production process monitoring, 3D metrology and surface metrology, semiconductor fabrication (solar cells)</li> </ul>
<b>Communications</b>	<ul style="list-style-type: none"> <li>affordable gigabit bandwidth fiber-link to homes and business (FTTX), test &amp; measurement for telecom network</li> </ul>
<b>Defense &amp; Security</b>	<ul style="list-style-type: none"> <li>perimeter defense, navigation and guidance - inertia sensing (gyroscope), infrared illumination for surveillance and speckle-free military imaging</li> </ul>

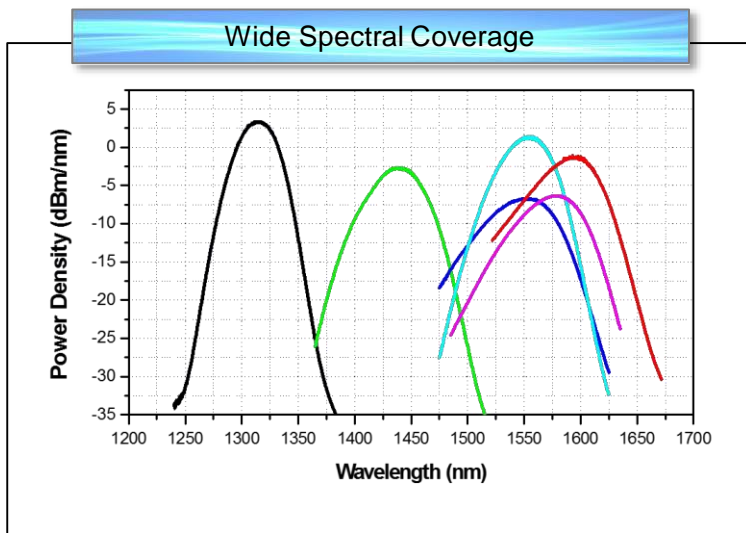

## PHYSICAL & MECHANICAL SPECIFICATION

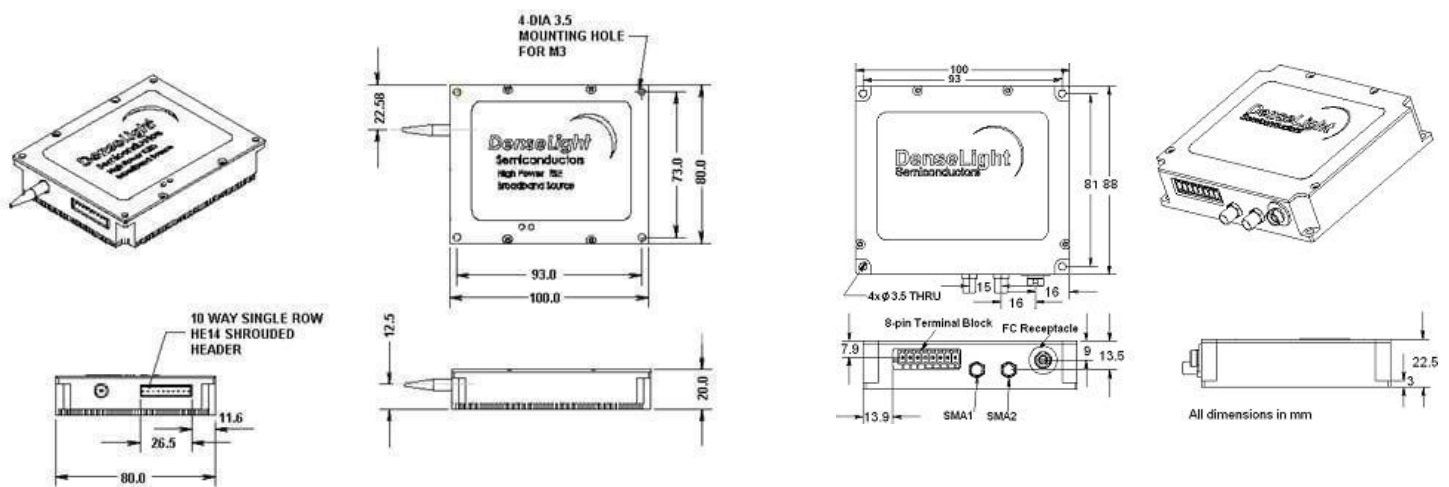

ASE (CW)

ASE (IM)

## MODULE SELECTION GUIDE

Telecom Band	Product Code	SLEDType	Wavelength Range	CWL	Band width	Power	Power Density	Usage Mode	Spectral Symmetry
			(nm)	(+/- 20 nm)	3dB	dBm	dBm/nm		Gaussian
O Band (1260 - 1360 nm)	DL-ASE-CW-CSO193A	DL-CS-3452A-FP	1285 - 1335	1310	32	19	-6.5	CW	Yes
	DL-ASE-CW-CSO157A	DL-CS-3207A-FP	1265 - 1365	1310	50	15	-12.5	CW	Yes
	DL-ASE-CW-CSO139A	DL-CS-3159A-FP	1250 - 1350	1310	75	13.5	-7.5	CW	Yes
	DL-ASE-CW-CSO119A	DL-CS-3159A-FP	1250-1350	1310	75	11	-12.5	CW	Yes
	DL-ASE-CW-C CSOE 109A	DL-CS-2079A-FP DL-CS- 35H5A-FP	1235-1380	1310	120	10	-15	CW	No
EBand (1360 - 1460 nm)	DL-ASE-CW-CSE145A	DL-CS-44H5A-FP	1420 - 1460	1450	50	14	-7.5	CW	Yes
SBand (1460 – 1530 nm)	DL-ASE-CW-CSS145A	DL-CS-48H5A-FP	1470-1506	1480	50	13.5	-9	CW	Yes
SCBand (1460-1565 nm)	DL-ASE-CW- CSSC 129A	DL-CS-53109A	1470-1565	1530	80	12	-10	CW	Yes
CBand (1530 – 1565 nm)	DL-ASE-CW-CSC183A	DL-DL-CS5403A- FP	1525 - 1565	1550	35	18	-3.5	CW	Yes
	DL-ASE-CW-CSC164A	DL-CS-5254A-FP	1525- 1565	1550	40	16	-5	CW	Yes
	DL-ASE-CW-CSC147A	DL-CS-5107A-FP	1510- 1590	1550	60	15	-7.5	CW	Yes
	DL-ASE-CW-CSC119A	DL-CS-5169A-FP	1510- 1590	1550	80	11.5	-9	CW	Yes
	DL-ASE-CW-CSC117A	DL-CS-5107A-FP	1525 - 1565	1550	60	11	-10	CW	Yes
	DL-ASE-CW-CSC107A	DL-CS-5107A-FP	1526 - 1565	1550	60	10	-11	IM	Yes
	DL-ASE-CW-CSC143A	DL-CS-5254A-FP	1525 - 1565	1550	40	14	-8	CW	Yes
CL Band ( 1525-1625 nm)	DL-ASE-CW-CSC117A	DL-CS58M7A-FP	1527 - 1610	1580	58	11	-15	CW	Yes
	DL-ASE-IM-CSC107A	DL-CS58M7A-FP	1526 - 1625	1580	58	10	-16	IM	Yes
L- Band (1565 – 1625 nm)	DL-ASE-CW-CSL165A	DL-CS60H5A-FP	1525-1610	1600	50	16	-6	CW	Yes
U Band (1625 – 1675 nm)	DL-ASE-CW-CSU125A	DL-CS65M5A-FP	1651-1691	1650	50	11.5	-13	CW	Yes
	DL-ASE-CW-CSU125A	DL-CS65M5A-FP	1625-1675	1650	50	11.5	-9	CW	Yes
	DL-ASE-CW-CSU135A	DL-CS69M5A-FP	1645-1710	1690	50	13	-10	CW	Yes



## Ultra-Narrow Linewidth Laser Single Frequency Lasers

### Plug & Play Modules

The **DL-BF9/BF10/BF12** series of integrated modules are designed for applications in optical metrology & instrumentation and optical gas & chemical sensing, requiring narrow spectral linewidth, excellent SMSR, power stability, and a very highly wavelength stable laser output. is complete with a DenseLight 14-pin BTF package laser, integrated laser driver & temperature controller. They are available over a wide wavelength range across the O, E, S, C and L bands which can be customized with various options to meet your specific needs.



### APPLICATIONS

- *Distributed temperature sensing (DTS)*
- *Out-of-band OTDR*
- *Optical metrology*
- *Gas/chemical sensing*
- *Fiber laser seeding*
- *LIDAR*

### PRODUCT DESCRIPTION

#### BF9 & BF10 Series

The DenseLight DL-BF9/BF10-CLSxxxB-Syyyy is a series of ultra narrow linewidth lasers. The DL-BF10 series comes with 2 direct modulation inputs (analog input: BW 20MHz & digital input: BW 200MHz).

#### BF12 Series

BF12-CLSxxxB-Syyyy-zz is a series of tuneable single frequency lasers, 10-Turn dial controlled electronics for picometer precision wavelength tuning over the selected tuning range. The DL-BF12 series comes with 2 direct modulation inputs (analog input: BW 20MHz & digital input: BW200MHz).

### FEATURES & PERFORMANCE

- Typical ultra-narrow linewidth < 10KHz, Optimized Systems < 5 KHz
- Wavelength availability from 1260 ~ 1670nm
- High power: CW up to 20mW
- Excellent RIN < -140dB/Hz (for power > 10mW)
- Excellent minimum SMSR > 45dB
- Wavelength stability: +/- 1pm @ 25 Deg C.
- Integrated laser driver and temperature controller
- Integrated optical isolator
- Dimension: L120 x W93 x H36.5 mm
- Telcordia qualified (GR-468-CORE)



**PRODUCT OFFERINGS**

We have packaged our DL-CLSseries of 14 pin butterfly Ultra-Narrow Linewidth Laser into a complete solution that incorporates a high precision controller for high output level and excellent stability of the laser diodes output; giving you greater convenience of usage!

		Direct Modulation	
		no	yes
Wavelength dial-tuning	no	BF9	BF10
	yes		BF12

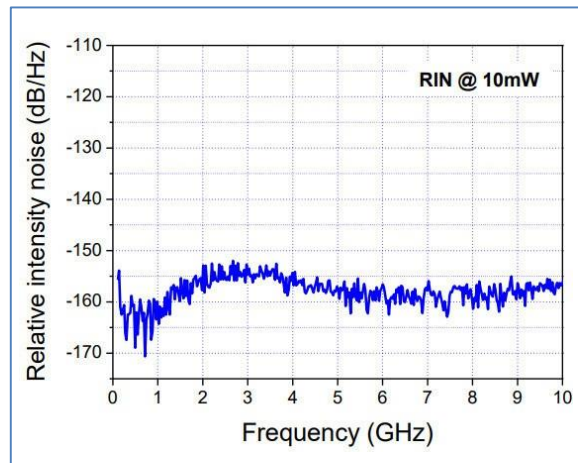
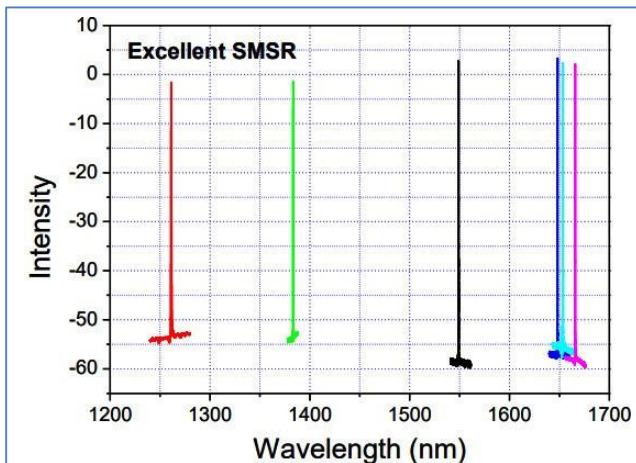
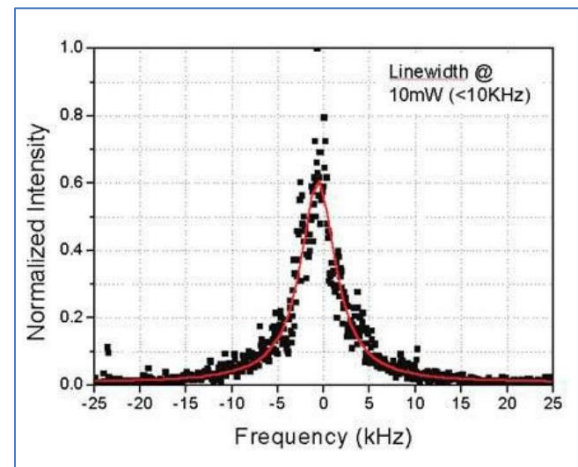
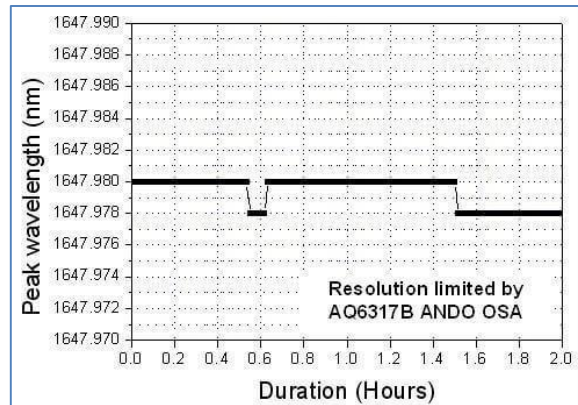
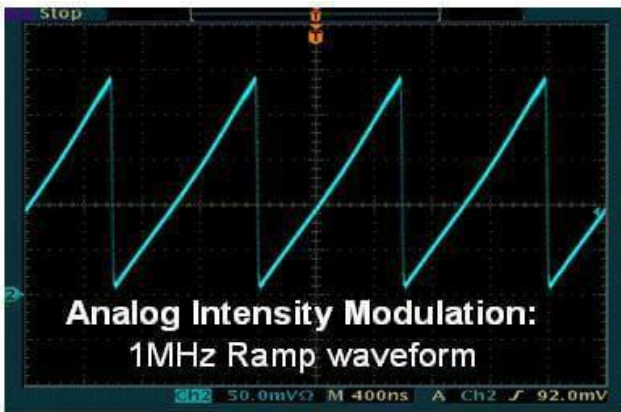



## Constellation Series

Single Frequency Narrow Line Width Lasers

### Plug & Play Modules

The **DL-BF9C** Constellation product series uses DenseLight's proprietary 14-pin butterfly package manufacturing process, enabling improved performance of the external cavity laser to give high PER performance, high stability line width, low RIN  $< -155$  dB/Hz & low phase noise performance

This series features a narrow linewidth of  $< 50$  KHz, &  $< 200$  KHz. option & a minimum output power of 10 mW. The Constellation ILM is suitable for embedded designs or stand alone uses in a wide range of communication and sensing application. When using the Constellation series, the fiber optic systems will operate at a premium performance level



### APPLICATIONS

- Acoustic Sensing
- Defence and Security
- Oil & Gas
- LIDAR
- Interferometric Sensing
- Metrology
- Coherent communication

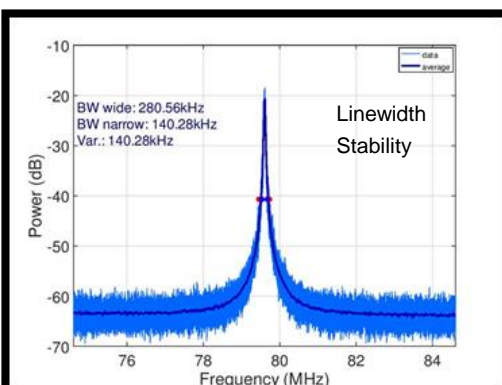
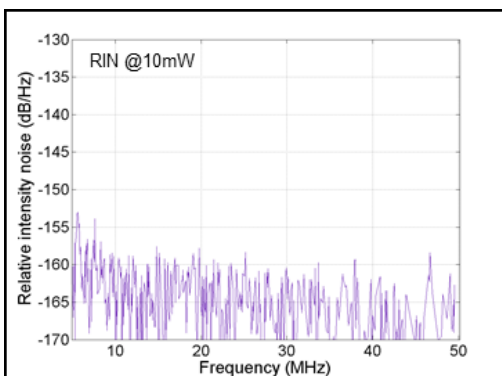

### FEATURES & PERFORMANCE

- Ultra-Narrow Linewidth  $< 50$  KHz &  $< 200$  KHz options.
- Excellent RIN  $< -155$  dB/Hz
- High Frequency stability within  $\pm 1$  pm after 15 minutes warm-up
- Excellent Typical SMSR
- Typical PER  $> 18$  dB (For PMF Option)
- CW  $> 10$  mW
- Mode-Hop-Free over  $0^{\circ}\text{C}$  to  $50^{\circ}\text{C}$
- Integrated optical isolator, Proprietary Laser Driver and temperature controller
- Over-temperature protection and internal PCB temperature monitor

## PRODUCT PERFORMANCE

Optical Parameters	Min	Max	Units
Output Power	10	-	mW
Centre Wavelength	1548	1552	nm
PER (PMF)	15		dB
Power Stability (8 hrs)	-0.05	+0.05	dB
Operating Temperature Range	0	50	Deg. C
Optical Isolation	45		dB

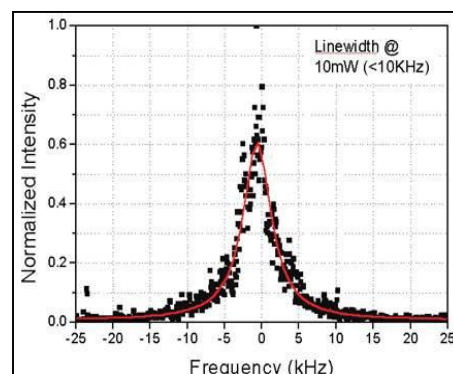

Noise Performance	Frequency Range		Typical Performance
RIN (Relative Intensity Noise)	0 Mhz	0.5 Mhz	-145 dB/Hz
	0.5 Mhz	10 Mhz	-150 dB/Hz
	10 Mhz	50 Mhz	-160 db/Hz
Phase Noise	10 Hz		190 uRad/sqrt-Hz
	200 Hz		22 uRad/sqr-Hz

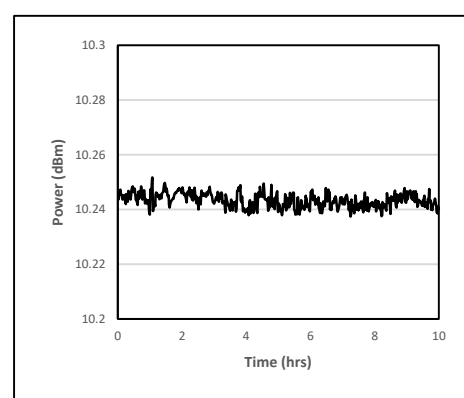

## PRODUCT OFFERING

Output Fiber Type	Line Width $\Delta\lambda$ (kHz)	Ordering Information
SM	< 50	DL-BF9C-CLS101B-S1550-LW050
	< 200	DL-BF9C-CLS101B-S1550-LW200
PM	< 50	DL-BF9C-CLS101B-FP-S1550-LW050
	< 200	DL-BF9C-CLS101B-FP-S1550-LW200

## SPECIFICATIONS

- Dimension: L120 x W93 x H36.5 mm
- Enclosure: Metal Case
- Cooling: Air-Cooled
- Optical Output: Receptacle
- Connector Type: FC/APC
- Electronic Interface: 8-pin terminal block
- Power Supply: 5V DC



## General Purpose SLED Integrated Light Modules

The Denselight BX, BZ-series of Integrated Infrared Light Module (I<sup>2</sup>LM) products are based on the proven performance DL-CS series of 14-PIN BUTTERFLY SLED. It is an ideal balance of cost-performance-value solution, for general purpose applications that require convenient usage, low wavelength sensitivity to environment, and lifetime reliability. The BX-series and BZ-series incorporate a compact form factor with precise controllers for high output level and excellent power stability.

**DL-BX** series is focused on providing a Precisely Power Tuned light source, with the functional feature of plugging-in-and providing infrared light, where absolute accuracy, stability, lifetime reliability and high resolution are vital. The **DL-BZ** line of I<sup>2</sup>LM series provides option to directly intensity modulate the SLED.



BZ1



BX9



BX10

### APPLICATIONS

*Structural Health Monitoring*

*Test & Measurement*

*Medical Technology*

*Navigation*

### PRODUCT DESCRIPTION

#### Extra Features in BX-9 Series

- Tunable optical power
- Over temperature protection
- Smallest size in I<sup>2</sup>LM family

#### Extra Features in BX-10 Series

- Over temperature protection and internal PCB temperature monitor
- Active-Low optical power enabled function
- Operating temperature up to 70 °C

#### Extra Features in BZ-1 Series

- Over temperature protection and internal PCB temperature monitor
- Pre-bias optical power
- Analog intensity modulation up to 20MHz
- Pulse or digital modulation up to 200MHz

### FEATURES & PERFORMANCE

- Excellent stable CW operation ( <0.01dB)
- Optical power range up to 50mW
- Wide 3dB spectral bandwidth of 25nm up to 100nm
- Integrated optical isolator
- Standard operating temperature: 0°C to 70°C
- Optical output: SMF or PMF fiber options with pigtail (BX) or with receptacle (BZ) options, with FC/APC connector
- Wavelength from 1200nm to 1700nm
- Customized design and features (Return Sensing Signal Port, Monitoring Optical Coupler or Application
- Specific Passive Components)
- Linearly voltage controlled tunable optical power
- Built-in current driver and temperature controller
- High wall-plug efficiency
- Telcordia qualified, RoHS Compliance

## PRODUCT OFFERINGS

Wavelength Range (nm)	Model selection DL-BX9-CSxxxxA, DL-BX10-CSxxxxA, DL-BZ1-CSxxxxA	Typ Module Power (mW)	Typ Module FWHM (nm)	Typ Module Ripple (dB)	
1260 - 1290	2079A	7	75	0.15	
	2184A	18	40	0.15	
1290 - 1330	3055A	5	50	0.15	
	3089A	8	75	0.2	
	3102A	10	30	0.15	
	3152A	15	30	0.15	
	3159A	15	83	0.25	
<u>Premium</u>	3184A	18	42	0.15	
	3202A	20	30	0.2	
	3207A	20	56	0.15	
	3307A	30	58	0.25	
	3404A	40	43	0.25	
	3452A	40	32	0.35	
	3504A	50	38	0.3	
	1330 - 1370	35H5A	13	48	0.2
	1380 - 1420	40H2A	15	35	0.2
	1415 - 1445	43H4A	15	45	0.2
1430 - 1470	44H4A	15	45	0.2	
1460 - 1500	48H5A	15	50	0.2	
	5037A	3	60	0.15	
1530 - 1570	5077A	5	60	0.2	
	5107A	8	60	0.2	
	5103A	10	40	0.15	
	51010A	10	100	0.25	
	<u>Premium</u>	5153A	15	40	0.2
1560 - 1600	5169A	16	80	0.3	
	5203A	20	40	0.25	
	5254A	25	40	0.25	
	5403A	35	40	0.35	
	58M7A	5	58	0.15	
1580 - 1620	6055A	5	55	0.15	
	6107A	8	60	0.15	
1600 - 1630	62M7A	8	60	0.15	
1635 - 1690	65M5A	10	50	0.2	
	69M5A	10	50	0.2	

### Applications Details

<b>Structure Health Monitoring (SHM)</b>	– sensing in gas & oil production, telemetry in electricity distribution (FOS)
<b>Test &amp; Measurement</b>	– physical (temp, pressure, strain, vibrations), structural and civil engineering, smart structures, intelligent distributed sensing (DTS & DTSS)
<b>Medical Technology</b>	– OCT (biopsies-less medical cell imaging, diagnostic imaging), point of use/ handhelds/ non-invasive diagnosis (blood analysis)
<b>Navigation</b>	– navigation and guidance - inertia sensing (Gyroscope)

- Due to insertion loss of integrated optical isolator, optical power and bandwidth in I<sup>2</sup>LM form can be up to 10% lower than corresponding DL-CS module
- All current model selections are available in Premium-, A- and B-Grade performance models which offer variety in Center Wavelength, Bandwidth, Power Ranges and Spectral Modulation Ranges

## PHYSICAL & MECHANICAL SPECIFICATION

- BX9 Dimension: L100 x W80 x H16 mm
- BX10 Dimension: L100 x W80 x H20 mm
- BZ1 Dimension: L100 x W88 x H22.5mm
- Enclosure: Metal Case
- Cooling: Air-Cooled
- Optical Output: Receptacle/Pigtail
- Connector Type: FC/APC
- Elec. Power supply: 5V DC





## Superluminescent Light Emitting Diodes (SLED)

DenseLight Semiconductors offers proprietary matching of our Infrared Light sources for custom and application specific needs of those who need to develop a Broadband Fiber-Coupled Light Sources for use in a variety of spectroscopy applications, is ideal for applications requiring wide spectral ranges in the NIR.

The DenseLight Light Source family covers all the bands needed for broadband and high-power requirements, our SLED-based light sources will cover all the main bands used in telecom applications, and communications and test applications. It provides a broader spectral range and high spectral density. Our product family is ideal for broadband applications, and passive component testing, as well as fiber-optic sensing and spectroscopy.



8-pin BTF



14-pin BTF



14-pin DIL

### APPLICATIONS

- Test & Measurement: Fiber Optics Network
- Medical Imaging, Patient Monitoring & Detection (OCT, Glucose Monitoring)
- Navigation & Stabilization: Fiber Optics Gyroscope
- Structural Health Monitoring: FBG Sensor Interrogation

### PRODUCT OFFERING

- Comprehensive Product Range
- Wavelength options between 1260nm to 1700nm
- Bandwidth options from typical 25nm to 100nm
- SLED sets available for covering spectrum between 1250nm to 1700nm
- FP/APC Connector termination with SMF & PMF Fiber Pigtail Options
- Depolarized Low DOP SLED option available in Integrated Light Module (DL-ASE series)

### FEATURES & PERFORMANCE

- Highest energy/ output efficiency in the market
- Comprehensive range to suit your needs
- Superior power and spectral coverage
- Telcordia and ISO9001:2008 certification
- RoHS Compliance
- High TE/TM ratio (>20dB possible)
- Direct Modulation up to 622 MHz available on request
- Low Coherence Noise
- Low Spectra Ripple (< 0.1db Low Power, < 0.3db Medium power, < 0.5db High Power)
- Relative Intensity Noise: Typ. -140dB/Hz to -125dB/Hz

## PRODUCT SELECTION

Center $\lambda$ (nm)	Product Code	Min Power (mW)	Typ BW FWHM (nm)	Typ Spectral Ripple (dB)	Package Options	Typ Iop (mA)	PD Option	General Applications
1275	DL-CS2079A	7	75	0.15	14 pin BTF	400	Yes	T&M – CT
	DL-CS2089A	8	75	0.2	14 pin BTF	400	Yes	T&M – CT
	DL-CS2184A/B	18	40	0.15	14 pin BTF/DIL	350	Yes	T&M – CT
1310	DL-CS3034L	0.3	43	0.1	14 pin DIL	100	Yes	T&M – Optical Networks
	DL-CS3059N	0.4	70	0.1	14 pin DIL	150	No	T&M – Optical Networks
	DL-CS3014A	1	43	0.1	14 pin DIL	150	Yes	T&M – Optical Networks
	DL-CS3024A/B	2	45	0.1	14 pin BTF/DIL	180	Yes	T&M – Optical Networks
	DL-CS3024C	2	45	0.1	8 pin BTF	180	Yes	Navigation
	DL-CS3055A/B	5	50	0.15	14 pin BTF/DIL	250	Yes	T&M – Comm. Test
	DL-CS3089A	8	75	0.2	14 pin BTF	400	Yes	T&M - Metrology
	DL-CS3102A/B	10	30	0.15	14 pin BTF/DIL	250	Yes	
	DL-CS3152A	15	30	0.15	14 pin BTF	300	Yes	T&M
	DL-CS3158A	15	60	0.3	14 pin BTF	500	Yes	T&M
	Premium DL-CS3159A	15	83	0.25	14 pin BTF	500	Yes	T&M, Med Tech
	DL-CS3184A/B	18	42	0.15	14 pin BTF/DIL	350	Yes	T&M
	DL-CS3202A/B	20	30	0.2	14 pin BTF/DIL	350	Yes	T&M
	DL-CS3207A	20	56	0.15	14 pin BTF	500	Yes	T&M
DL-CS3307A	30	58	0.25	14 pin BTF	700	Yes		
DL-CS3404A	40	43	0.25	14 pin BTF	700	Yes	T&M, FOS	
DL-CS3452A	40	32	0.35	14 pin BTF	700	Yes	T&M	
DL-CS3504A	50	38	0.3	14 pin BTF	700	Yes	T&M	
1340	DL-CS3059L	0.4	80	0.1	14 pin DIL	180	No	T&M – Optical Networks
1350	DL-CS35M9A	8	80	0.25	14 pin BTF	400	Yes	T&M – Optical Networks
	DL-CS35H5A	13	48	0.2	14 pin BTF	350	Yes	T&M – Optical Networks
1390	DL-CS39L5B	3	55	0.1	14 pin DIL	200	Yes	T&M – Optical Networks
	DL-CS39107A	8	55	0.3	14 pin BTF	400	Yes	T&M
1400	DL-CS40H2A/B	15	35	0.2	14 pin BTF/DIL	350	Yes	T&M – Optical Networks
1430	DL-CS43H4A	15	45	0.2	14 pin BTF	350	Yes	T&M – Optical Networks
1450	DL-CS44H4A	15	45	0.2	14 pin BTF	350	Yes	T&M – Optical Networks
	DL-CS44H5A	25	50	0.3	14 pin BTF	600	Yes	T&M – Optical Networks
1480	DL-CS48H5A/B	15	50	0.2	14 pin BTF/DIL	350	Yes	T&M – Optical Networks
1510	DL-CS5029L	0.2	100	0.1	14 pin DIL	180	No	T&M – Optical Networks
1530	DL-CS53107A	8	60	0.3	14 pin BTF	500	Yes	T&M, SHM

## PRODUCT OFFERINGS

Center $\lambda$ (nm)	Product Code	Min Power (mW)	Typ BW FWHM (nm)	Typ Spectral Ripple (dB)	Package Options	Typ Iop (mA)	PD Option	General Applications
1550	DL-CS5029N	0.2	95	0.1	14 pin DIL	150	No	T&M – Optical Networks
	DL-CS5014A	1	43	0.15	14 pin DIL	125	Yes	T&M – Optical Networks
	DL-CS50L4C	1	40	0.15	8-pin BTF	130	Yes	T&M/NAV
	DL-CS5027B	2.5	60	0.15	14 pin DIL	180	Yes	T&M
	DL-CS5037C-FP	3	60	0.15	8-Pin BTF	250	Yes	Nav
	DL-CS5057C-FP	5	60	0.2	8-pin BTF	300	Yes	T&M
	DL-CS5037A/B	3	60	0.15	14 pin BTF/DIL	250	Yes	T&M
	DL-CS5077A/B	5	60	0.2	14 pin BTF/DIL	250	Yes	T&M – Comm Test
	DL-CS5107A/B	8	60	0.2	14 pin BTF/DIL	300	Yes	T&M/NAV
	DL-CS5103A/B	10	40	0.15	14 pin BTF/DIL	300	Yes	NAV
<b>Premium</b>	DL-CS51010A-T30	10	100	0.25	14-Pin BTF	600	Yes	T&M/SHM
	DL-CS5153A	15	40	0.2	14 pin BTF	350	Yes	T&M/SHM
<b>Premium</b>	DL-CS5169A/-T20	16	80	0.3	14 pin BTF	500	Yes	T&M/SHM
	DL-CS5203A	20	40	0.25	14 pin BTF	450	Yes	T&M/SHM
	DL-CS5254A	25	40	0.25	14 pin BTF	450	Yes	T&M/SHM
	DL-CS5403A	35	40	0.35	14 pin BTF	650	Yes	T&M – CT
1560	DL-CS56107A	8	65	0.2	14 pin BTF	350	Yes	T&M-Comm Test
1580	DL-CS58L9B	1.5	95	0.1	14 pin DIL	250	Yes	T&M
	DL-CS58M7A	5	58	0.15	14 pin BTF	250	Yes	T&M
1600	DL-CS6055A/B	5	55	0.15	14 pin BTF/DIL	200	Yes	T&M
	DL-CS6107A/B	8	60	0.15	14 pin BTF/DIL	300	Yes	T&M
	DL-CS60H2A	25	30	0.35	14 pin BTF	650	Yes	T&M/FOS
1620	DL-CS62M7A/B	8	60	0.15	14 pin BTF/DIL	300	Yes	T&M/FOS
	DL-CS62H2A	20	30	0.3	14 pin BTF	500	Yes	T&M/FOS
1650	DL-CS65L9A	2	85	0.1	14 pin BTF	300	Yes	T&M/FOS
	DL-CS65M5A	10	50	0.2	14 pin BTF	350	Yes	T&M/FOS
	DL-CS65H5A	15	50	0.3	14 pin BTF	350	Yes	T&M/FOS
1680	DL-CS68M5A	15	50	0.3	14 pin BTF	500	Yes	T&M/FOS
1690	DL-CS69M5A	10	50	0.15	14 pin BTF	400	Yes	T&M/FOS
1690	DL-CS69H5A	15	50	0.3	14 pin BTF	500	Yes	T&M/FOS

### **Premium Grade SLED**

Premium Products are offered in 3 CWL, 3 Bandwidth Families, 3 Power Ranges, 3 Spectral Modulation Ranges, known as P-Premium Grade, A Grade, and B Grade.

Product Family 1310: Premium Grade is the CS 3159A, Featuring 83 (Typ) BW, 16mW Power(Typ)

Product Family 1550: Premium Grade is the CS 5169A, Featuring 80 (Typ) BW, 16mW Power (Typ)

CS 51010A-T30, Featuring 100 (Typ) BW, 10mW Power (Typ)

Product Family 1600/1620/1680: Offering high power and bandwidth (>30nm).





## Uncooled Edge- Emitting LEDs

The DenseLight DL-US series are uncooled edge emitting LEDs in TO-can or coaxial pigtail package engineered for optical communication systems and test instruments. It operates over a wide temperature range from 0 to 70C without any need for a thermoelectric cooler and temperature controller.

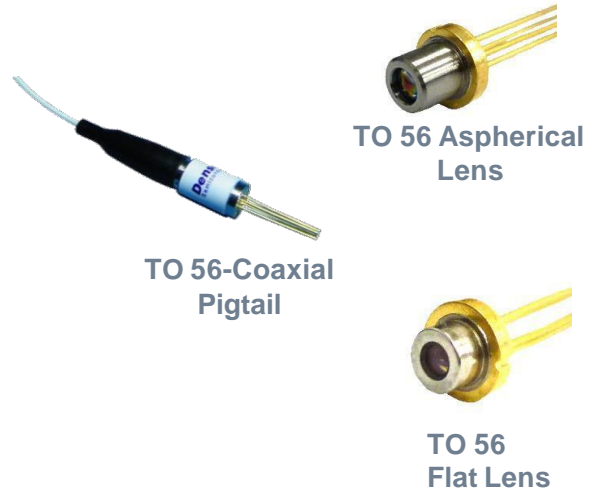

TO 56 Aspherical  
Lens

TO 56-Coaxial  
Pigtail

TO 56  
Flat Lens

## APPLICATIONS

- Reconfigurable Optical Add-Drop Multiplexer (ROADM)
- Optical test instrument
- Fiber optic sensors
- Optical metrology
- OTDR
- Optical transceiver
- Power line transmission monitor

## FEATURES & PERFORMANCE

- Uncooled SLED in TO-can, coaxial pigtail or collimation TOSA
- High coupled power to SMF /MMF
- Narrow beam divergence upon collimation (free-space model)
- Center wavelength of 1310nm and 1550nm (for datacom), other wavelengths on request
- Form factor available: TO-56, TO-56 coaxial pigtail, and others on request
- Cost effective and flexible manufacturing process
- Monitoring photo diode(Optional)

**PRODUCT OFFERINGS**

Center Wavelength (nm)	Product Code	Min Power (mW)	Min Bandwidth FWHM (nm)	Package Options	Typ Iop (mA)
1310	DL-US3054D-PD	0.5	35	TO-56 Aspherical Lens with PD	100
	DL-US3154D-PD	1.5	35	TO-56 Aspherical Lens with PD	100
	DL-US3044H	0.4	40	TO-56 Flat Lens	100
	DL-US3064H	0.6	40	TO-56 Flat Lens	100
	DL-US3104H	1	40	TO-56 Flat Lens	100
	DL-US3084D	0.8	40	TO-56 Aspherical Lens	100
	DL-US31014D-FS*	0.15	40	TO-56 SMF Coaxial Pigtail	100
	DL-US31034D-FS*	0.3	40	TO-56 SMF Coaxial Pigtail	120
1530	DL-US53084H-D	0.8	40	TO-56 Flat Lens	120
1550	DL-US5054D-PD	0.5	35	TO-56 Aspherical Lens with PD	120
	DL-US5154D-PD	1.5	35	TO-56 Aspherical Lens with PD	120
	DL-US5084D	0.8	40	TO-56 Aspherical Lens	120
	DL-US55016D-FS*	0.12	50	TO-56 SMF Coaxial Pigtail	125
	DL-US55036D-FS*	0.25	50	TO-56 SMF Coaxial Pigtail	125

\*TO-56 SMF Coaxial Pigtail with PD is available

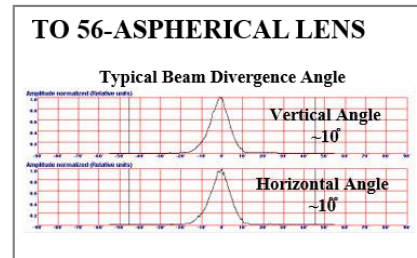
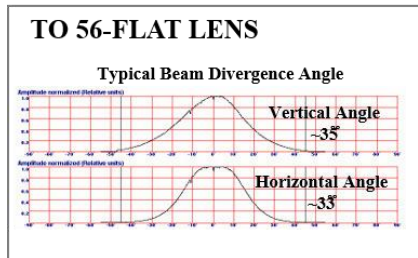
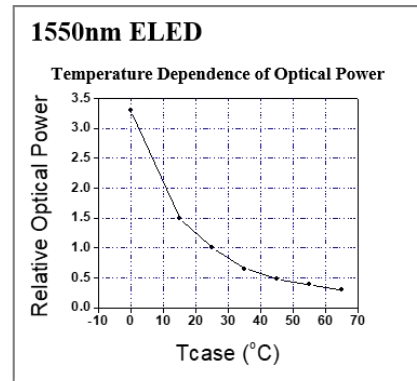
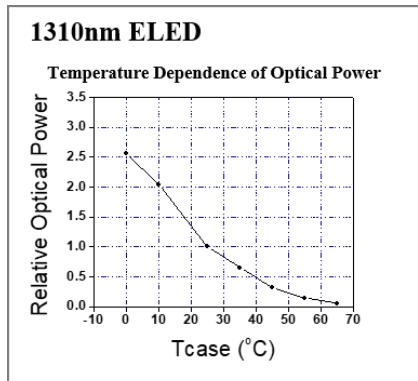

**PHYSICAL & MECHANICAL SPECIFICATION**

**TO 56 Flat Lens**

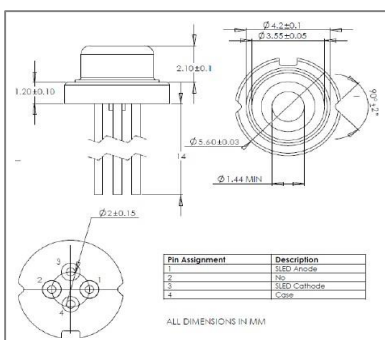

**TO 56 Aspherical Lens**

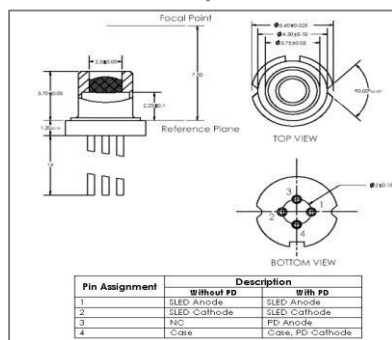

**TO 56 Coaxial Pigtail**

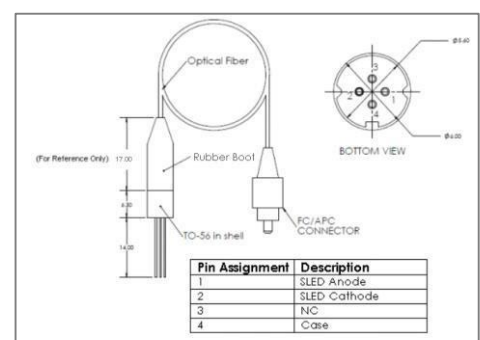



## Ultra-Narrow Linewidth Lasers

DenseLight DL-CLS series is a cooled narrow linewidth laser in 14-pin BTF/DIL package with a single frequency emission. The DL-CLS laser family is based on proprietary external cavity laser design utilizing a built-in fiber Bragg grating, offering very stable performance of lasing wavelength, narrow spectral linewidth and excellent SMSR.

The as-built lasing wavelength can be specified precisely to 1nm. The device can directly intensity modulated up to 622MBPS. Typical output power is up to 10mW CW, with Pulse Power up to 50mW.



14-pin BTF



14-pin DIL

### APPLICATIONS

- *Distributed temperature sensing (DTSS by B-OTDR)*
- *Gas/chemical (e.g. methane) sensing and moisture detection*
- *Fiber Laser seeding for LIDAR*
- *Out-of-band Live OTDR*
- *Microwave generation by beat-note signal*

### PRODUCT DESCRIPTION

- Premium version of Ultra-Narrow Linewidth <10KHz available upon high volume request
- Customizable grating for specific wavelength (1260-1670nm)
- Selectable ITU-grid in C band wavelength available for high volume request
- SMF or PMF pigtail output

### FEATURES & PERFORMANCE

- Typical Narrow Linewidth < 200KHz (Coherence length>0.5km)
- 6 product families available (1260nm,1383nm,1550nm,1648nm, 1653nm and 1665nm)
- High power: CW up to 10mW, Pulse up to 50mW (10μs Pulse Width, 1% Duty cycle)
- Excellent RIN< -140 dB/Hz (for power >10mW)
- Excellent typical SMSR: 50 dB
- Wavelength stability: ±1 pm
- Typical PER: 18 dB
- Direct Intensity Modulation up to 622Mbps
- Telcordia qualified (GR-468-CORE)

## PRODUCT OFFERINGS

Currently available wavelengths (please check with factory for the latest list)

Peak Wavelength (nm)	Product Code	Fiber Type	Operating Condition	Minimum Power (mW)	Typical Spectrum Linewidth (kHz)	Minimum SMSR (dB)	Packaging Option
1260	DL-CLS051B/D-S1260	SMF	CW	5	200	45	BTF/DIL
	DL-CLS309B/D-S1260	SMF	Pulse	30	200	45	BTF/DIL
1383	DL-CLS051B/D-S1383	SMF	CW	5	200	45	BTF/DIL
	DL-CLS409B/D-S1383	SMF	Pulse	40	200	45	BTF/DIL
1550	DL-CLS101B-S1550	SMF	CW	10	200	45	BTF
	DL-CLS101B-FP-S1550	PMF	CW	10	200	45	BTF
1648	DL-CLS051B/D-S1648	SMF	CW	5	200	45	BTF/DIL
	DL-CLS409B-S1648	SMF	Pulse	40	200	45	BTF
1653	DL-CLS081B-S1653	SMF	CW	8	200	45	BTF
1665	DL-CLS051B-S1665	SMF	CW	5	200	45	BTF

### Note:

Typical linewidth can be narrowed down to **Ultra-Narrow Linewidth** < 5KHz when using Integrated InfraRed Light Module (I<sup>2</sup>LM) **BF**-series with high precision laser driver and temperature controller. Further precision wavelength (DOWN TO PICOMETER RANGE) CAN BE ACHIEVED THROUGH TUNING THE INTERNAL TEMPERATURE OR DRIVE CURRENT.

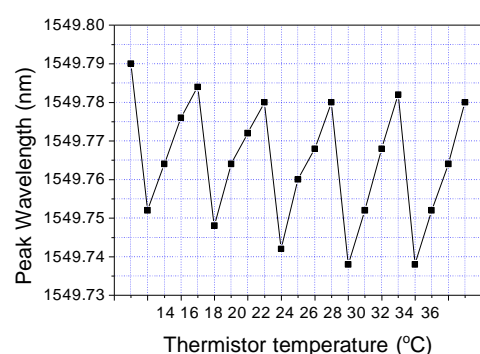
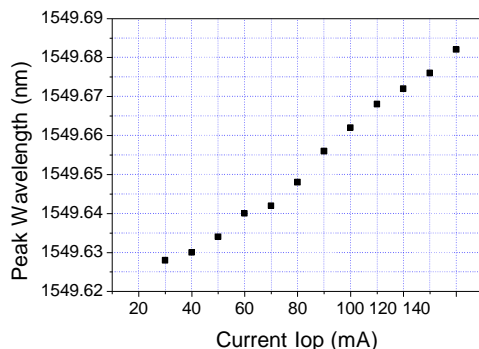
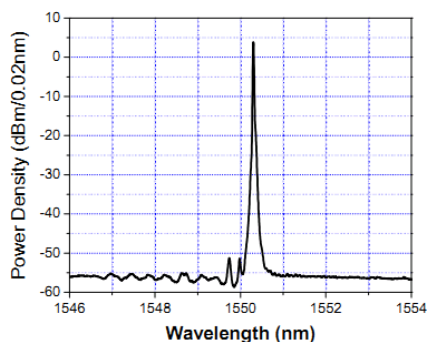
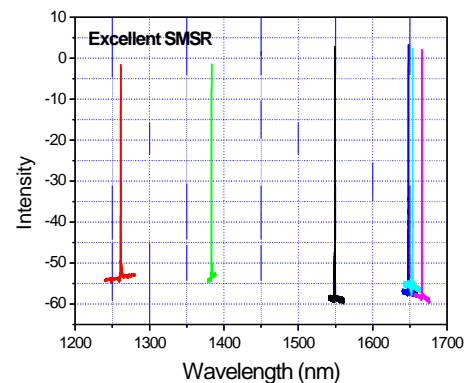
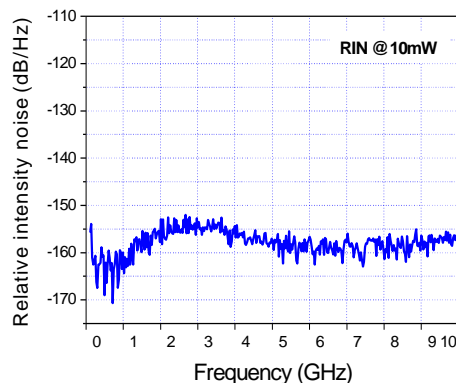
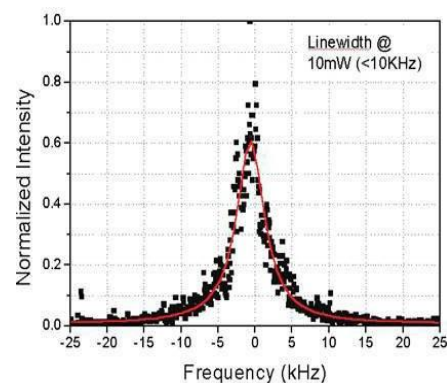



## SLED SETS

Denselight offers proprietary matching of our SLEDs, to produce a multi product combination, which combines a single spatial mode, across a broad spectrum for both sensing or telecom applications that require a broadband spectrum

With a total output power up to 50 mW, that covers a range of from 1250 nm to 1700 nm, the Denselight SLED offering provides unparalleled flexibility, value and versatility, for those customers who need quick agile alternatives for drop in IR Light sources, to fulfill spectrum needs.

The Denselight Light Source family, provides the required spectral stability, and total output power stability required for both application specific, and specific spectral regions of interest. Our Light Source Family of SLED's also provides the necessary Spectral Power Density as a key attribute, required for sensing applications and telecom uses which may or may not have polarization dependencies.

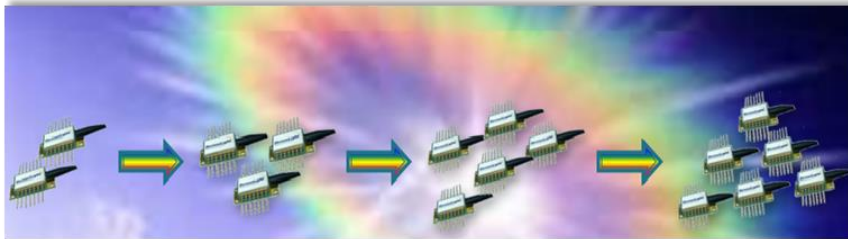

## APPLICATIONS

Broadband Fiber-Coupled Light Sources for Spectroscopy, telecommunication, test & measurements, component testing

## PRODUCT DESCRIPTION

**Multiple Light Source Matching in One Broad Band Source** – For multiple wavelength testing, our Dual (2) to Six (6) SLED combinations cover all the major network bands, which enables accurate characterization of fiber links and their passive components, with a very cost-effective test set up. Use our 1300nm/1500nm source for most major passive components; Isolators, Couplers

**SLED Light Sources Choice Selection for Component testing** – DenseLight's diverse SLED line of products offers enough variety of choice in power selection along with spectral symmetry. You can efficiently qualify your components during your systems & components development and perform Pass/Fail testing during production.

**High Spectral Density Stability** – High spectral density stability is essential to ensure that the test setup products accurate measurements. The more stable the spectrum, the less often a reference trace has to be acquired

## FEATURES & PERFORMANCE

- **Single SLED:** 1275nm, 1310nm, 1440nm, 1530nm, 1550nm, 1600nm, 1620nm, 1650nm
- **Dual SLED Combinations:** 1230-1400nm, 1450-1670nm. (other wavelengths available upon request)

Telecom Band	Wavelength (nm)	Min. Power Density (dBm/0.1n m)*	Mad. Spectral Flatness (dB)	Number of SLEDs
O-E	1230-1400	-30	3	2
O-L	1250-1600	-30	14	3
O-U	1250-1650	-25	10	4
	1250-1650	-22	8.5	5
	1250-1700	-25	2	6
S-U	1450-1670	-30	2	2

\* Insertion loss of passive optical components is not included

## Typical Spectrum of SLED Sets

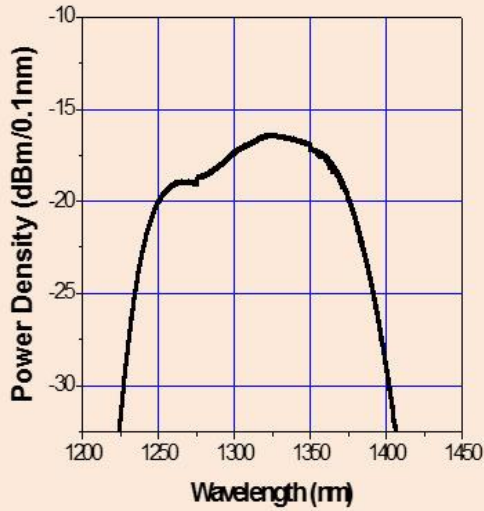

Spectrum Combination of 2 SLEDs  
(1230-1400 nm)

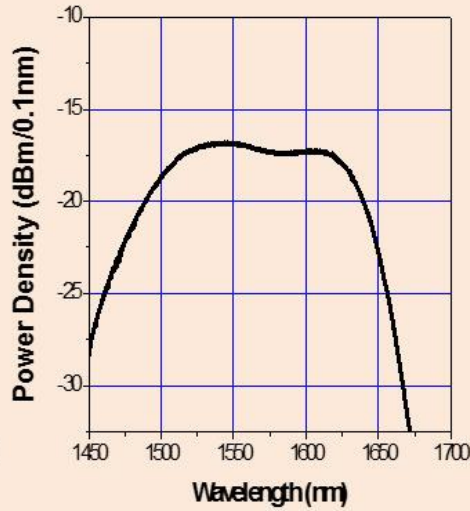

Spectrum Combination of 2 SLEDs  
(1450-1670nm)

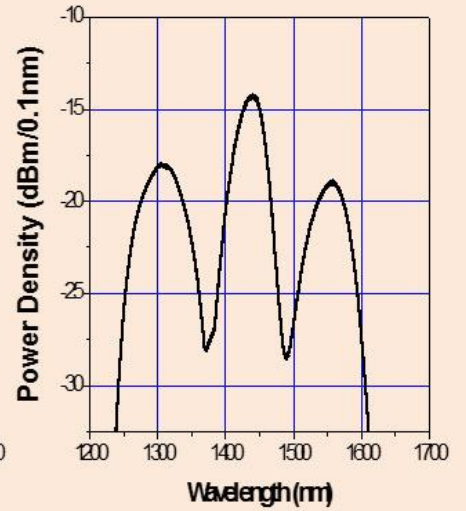

Spectrum Combination of 3 SLEDs  
(1250-1600 nm)

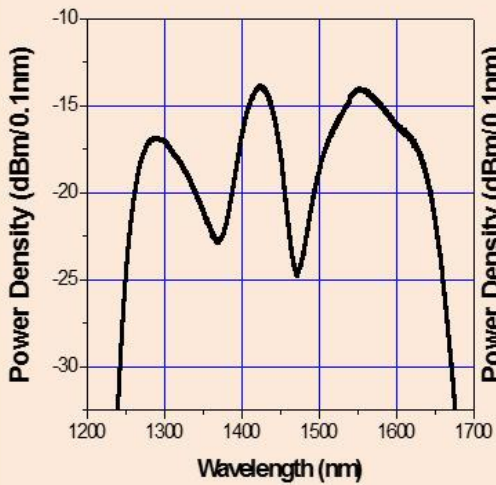

Spectrum Combination of 4 SLEDs  
(1250-1650 nm)

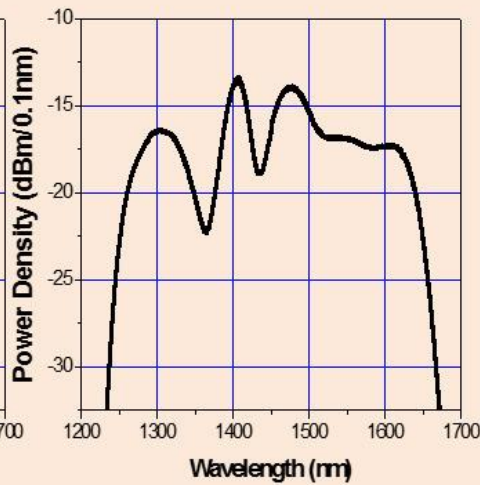

Spectrum Combination of 5 SLEDs  
(1250-1650 nm)

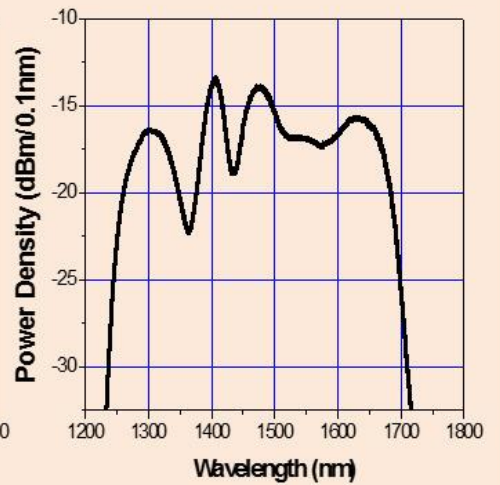

Spectrum Combination of 6 SLEDs  
(1250-1700 nm)

### ***About DenseLight***

DenseLight Semiconductors is a Singapore-based innovator, manufacturer and provider of photonic sensing and optical light source products to diverse industries such as communications, medical, instrumentation, defense and security.

DenseLight processes optoelectronic devices and photonic integrated circuits based on Indium Phosphide (InP) and Gallium Arsenide (GaAs) through its in-house wafer fabrication, assembly and test facilities.

DenseLight is recognised worldwide for its technological innovations in high performance semiconductor infrared superluminescent light sources and lasers, with a proven track record in deployed applications. It is a wholly owned subsidiary of POET Technologies, a US-based, Toronto-listed developer of opto-electronics and photonics devices.



**DenseLight Semiconductor Pte Ltd**  
6 Changi North Street 2  
Singapore 498831