

PPM-350D

PON Power Meter



Copyright © 2018 EXFO Inc. All rights reserved. No part of this publication may be reproduced, stored in a retrieval system or transmitted in any form, be it electronically, mechanically, or by any other means such as photocopying, recording or otherwise, without the prior written permission of EXFO Inc. (EXFO).

Information provided by EXFO is believed to be accurate and reliable. However, no responsibility is assumed by EXFO for its use nor for any infringements of patents or other rights of third parties that may result from its use. No license is granted by implication or otherwise under any patent rights of EXFO.

EXFO's Commerce And Government Entities (CAGE) code under the North Atlantic Treaty Organization (NATO) is 0L8C3.

The information contained in this publication is subject to change without notice.

Trademarks

EXFO's trademarks have been identified as such. However, the presence or absence of such identification does not affect the legal status of any trademark.

Units of Measurement

Units of measurement in this publication conform to SI standards and practices.

Version number: 1.0.0.1

Contents

Certification Information	v
European Community Declaration of Conformity	vi
1 Introducing the PPM-350D PON Power Meter	1
Main Features	1
PON-aware™ Feature	5
Available Options	6
Power Sources	7
Typical Applications	7
Technical Specifications	8
Conventions	9
2 Safety Information	11
Other Safety Symbols on Your Unit	13
Laser Safety Information (Models with VFL)	14
Electrical Safety Information	15
3 Getting Started with Your PON Power Meter	19
Turning the Unit On and Off	19
Physical Interface	19
Installing the EXFO Universal Interface (EUI)	20
Cleaning and Connecting Optical Fibers	21
Menu	23
Setting Parameters	24
Measurement Status and Icons	26
4 Test Configuration	29
5 Performing FTTx Measurements	31
Thresholds	31
Performing a Measurement	33
Reference Dialog	35
Working in dB (Loss) Mode	36
6 Managing Test Results	37
Storing Data	37
Results Navigator	38
Deleting Data	38
7 Identifying Fiber Faults Visually	39

Contents

8 OPM Smart Device	41
9 Maintenance	43
Cleaning EUI Connectors	44
Recharging the Battery	46
Replacing the Battery	46
Recalibrating the Unit	49
Recycling and Disposal	51
10 Troubleshooting	53
Solving Common Problems	53
Contacting the Technical Support Group	54
Transportation	55
11 Warranty	57
General Information	57
Liability	58
Exclusions	59
Certification	59
Service and Repairs	60
EXFO Service Centers Worldwide	61

Certification Information

North America Regulatory Statement

This unit was certified by an agency approved in both Canada and the United States of America. It has been evaluated according to applicable North American approved standards for product safety for use in Canada and the United States.

Electronic test and measurement equipment is exempt from FCC part 15, subpart B compliance in the United States of America and from ICES-003 compliance in Canada. However, EXFO Inc. makes reasonable efforts to ensure compliance to the applicable standards.

The limits set by these standards are designed to provide reasonable protection against harmful interference when the equipment is operated in a commercial environment. This equipment generates, uses, and can radiate radio frequency energy and, if not installed and used in accordance with the user guide, may cause harmful interference to radio communications. Operation of this equipment in a residential area is likely to cause harmful interference in which case the user will be required to correct the interference at his own expense.

Modifications not expressly approved by the manufacturer could void the user's authority to operate the equipment.

Certification Information

European Community Declaration of Conformity

Your unit comes with an internal wireless module and antenna for which the following information applies:

- This equipment has been tested and found to comply with the limits for a Class A digital device, pursuant to Part 15 of the FCC Rules.
- This device complies with Industry Canada license-exempt RSS standard(s). Operation is subject to the following two conditions: (1) This device may not cause harmful interference, and (2) this device must accept any interference received, including interference that may cause undesired operation.
- This device complies with the US/Canada portable RF exposure limit set forth for an uncontrolled environment and is safe for intended operation as described in this user documentation. The further RF exposure reduction can be achieved if the device can be kept as far as possible from the user's body.
- This device does not contain any user-serviceable components. Any unauthorized product changes or modifications will invalidate warranty and all applicable regulatory certifications and approvals.

European Community Declaration of Conformity

Warning: This is a class A product. In a domestic environment, this product may cause radio interference in which case the user may be required to take adequate measures.

Hereby, EXFO declares that the radio equipment type "Wideband Data Transmission" is in compliance with European Directive 2014/53/EU.

The full text of the EU declaration of conformity is available at the following Internet address: *www.exfo.com/library*.

The information about the Bluetooth® frequency band is as follows:

Between the frequencies 2400.0 MHz - 2483.5 MHz.

The output power is 10.0 dBm typical.

Certification Information

European Community Declaration of Conformity

This device is a 2.4 GHz wideband transmission system (transceiver), intended for use in all EU member states and EFTA countries, except in France and Italy where restrictive use applies.

In Italy, the end-user should apply for a license at the national spectrum authorities in order to obtain authorization to use the device for setting up outdoor radio links and/or for supplying access to telecommunications and/or network services.

This device may not be used for setting up radio links in France, and in some areas the RF output power may be limited to 10 mW EIRP in the frequency range of 2454 - 2483.5 MHz. For detailed information, the end-user should contact the national spectrum authority in France.

1 **Introducing the PPM-350D PON Power Meter**

The PPM-350D can be used in legacy and next-generation PON (passive optical network) power meter scenarios. It is compatible with single-layer and dual-layer plus RF overlays with upstream and downstream bit rates of 1 G, 2.5 G, and 10 G. The PPM-350D PON Power Meter provides a suite of FTTP testing needs and is easy to use especially for those not familiar with fiber optics in FTTx. The PPM-350D supports the following applications:

- Single/multi-layer PON service activation
- Insertion loss testing (downstream measurements)
- Multiple PON technologies:
 - GPON (ITU-T G984.2)
 - EPON (IEEE 802.3)
 - XG(S)-PON (ITU-T G987.2)
 - NG-PON2 (ITU-T G989.2)
 - RF overlay (ITU-T G983.3)
 - RFoG (ANSI/SCTE 174 2010)

Main Features

- PON-aware™ automatically detects PON technology in use and automatically discriminates the active PON layer in PON multi-layer network.
- Bluetooth and USB connectivity.
- Smart app to store results, create test reports, share results, and much more.

Introducing the PPM-350D PON Power Meter

Main Features

- Supports:
 - 10 G-capable PON networks
 - Port 1: ONT (optical network terminal) at 1270, 1310, 1524-1544, 1550, 1610 nm; depending on the selected option.
 - Port 2: OLT (optical line termination) OLT at 1490, 1575-1580, 1596-1603, 1610, and RFoG (RF over Glass) at 1555 nm; depending on the selected option.
- Pass-through device (spy mode) that does not block communication between ONT and OLT.
- Allows triple-play testing (voice, video and data).
- Measures each signal independently up to two PON layers + RF overlay.
- Measures optical power of any type of signal:
 - Continuous (for example, TV signal at 1550 nm)
 - All baud rates (for example, 1 and 10 Gbps; synchronous or asynchronous).
- Measures all signals simultaneously.
- Displays all signal statuses simultaneously on screen as well as a global status.
- Displays all power levels simultaneously.
- Contains several different test configurations. You can configure thresholds on a computer and transfer them to your PPM-350D with a smart device and Bluetooth connection.
- Touchscreen interface.

Other Useful Features

- You can disable or configure the **Auto-Off** from 2 to 30 min of idle time to automatically power off the unit.
- Manage data directly on the unit (storing, recalling pass/fail statuses, deleting) and has an internal storage up to 3500 results.
- Smart app features (Test Config management, data transfer, reporting). Sync results with smart app.
- Real time storage sync to smart device.
- Navigate through test point IDs.
- Loss measurement with reference.
- Editable reference (enter value measured by another remote unit).
- APC connectors.
- Compact, rugged and designed to comply with the IP54 enclosure standard.
- Rechargeable battery lasts for 8 hours or more of continuous use.

Introducing the PPM-350D PON Power Meter

Main Features

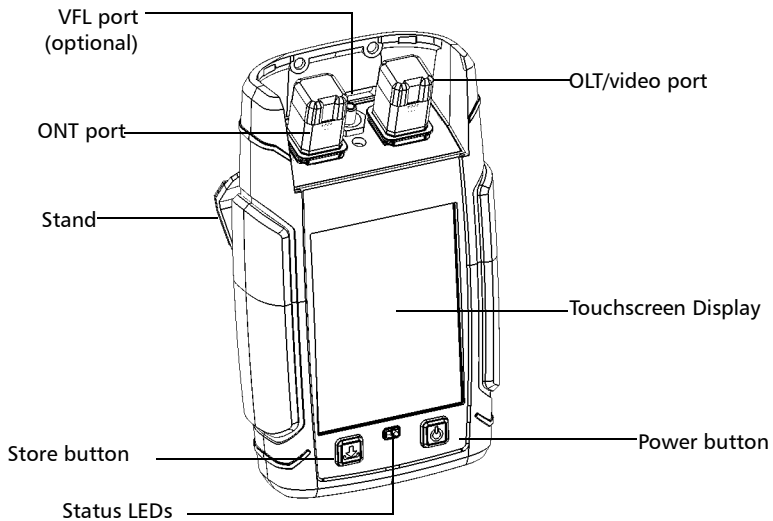

Bottom View

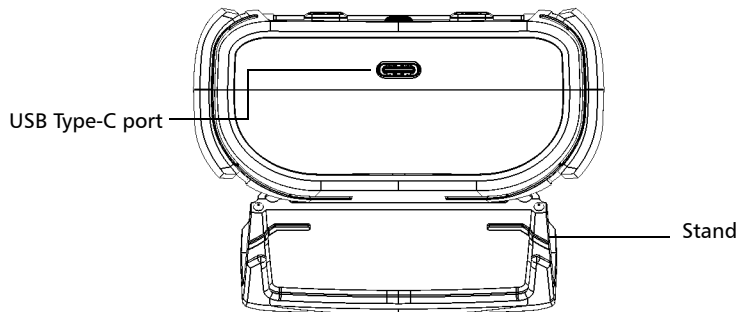

PON-aware™ Feature

The PON-aware feature in the PPM-350D automatically detects and adapts test parameters and thresholds for the PON technology in use at the customer premises on multiple service networks. These new capabilities eliminate costly guesswork during the critical service activation phase. The feature enables you to accurately test and thereby fix any customer connections during service activation for legacy and next-gen PON technologies such as GPON, EPON, XG-PON1, XGS-PON, 10G-EPON, and NG-PON2.

When used in a pass-through configuration on the ONT side of the splitter, start with selecting a configuration representing your multi-service network (GPON+XGS, GPON+NG-PON2, EPON+10G-EPON, etc). Using the wavelength detected from the ONT, the unit will figure out if the ONT is operating in GPON/EPON or in XG/XGS/NG-PON2/10G-EPON. It will then apply the global pass/fail status only to the corresponding service in your configuration. The rest of the measurements will still be shown with their respective status, but they won't affect the global status.

Note: *The PON-aware feature can only discriminate between GPON/EPON and XG/XGS/NG-PON2/10G-EPON.*

Available Options

The PON Power Meter is offered in the following options:

Option	Description
VFL	The unit will have a VFL in addition to the ONT and OLT ports.
SR	Single PON layer + RFoG to test the following layers: <ul style="list-style-type: none">➤ GPON + RF➤ EPON + RF➤ RFoG
D	Dual PON Layer to test the following layers: <ul style="list-style-type: none">➤ GPON + XG/XGS PON➤ GPON + NG-PON2➤ GPON + ALT➤ EPON + 10G-EPON
DR	Dual PON layer + RF to test the following layers: <ul style="list-style-type: none">➤ GPON + XG/XGS PON + RF➤ GPON + NG-PON2 + RF➤ EPON + 10G-EPON + RF➤ GPON + RFoG

Power Sources

The PON Power Meter operates with the following power sources:

- USB Type-C connector (connected to standard USB port on a computer or USB charger—indoor use only).
- Rechargeable internal Lithium-ion (Li-Ion) battery. Charging time is quickest when you use the provided cable and power supply or equivalent.



IMPORTANT

If the battery level becomes too low, the unit turns itself off.

Typical Applications

You can use your PON Power Meter in 3 modes:

- FTTx Power mode: You can use your PPM-350D PON Power Meter during service activation (at ONT) or to troubleshoot passive optical networks (at ONT, drop terminal, fiber distribution hub, or CO). This mode allows you to measure up to 4 wavelengths simultaneously, depending on the configuration of the unit.
- FTTx Loss mode (downstream only): You can also use your PPM-350D in relative mode (dB) to measure the loss of a whole PON network or only the drop cable by referencing power at a first location and performing measurement in dB at a second location.

Introducing the PPM-350D PON Power Meter

Technical Specifications

- Remote reference: Additionally, the power reference can be edited manually when reference power is measured by another unit and user, a far end location (for example, at a CO).

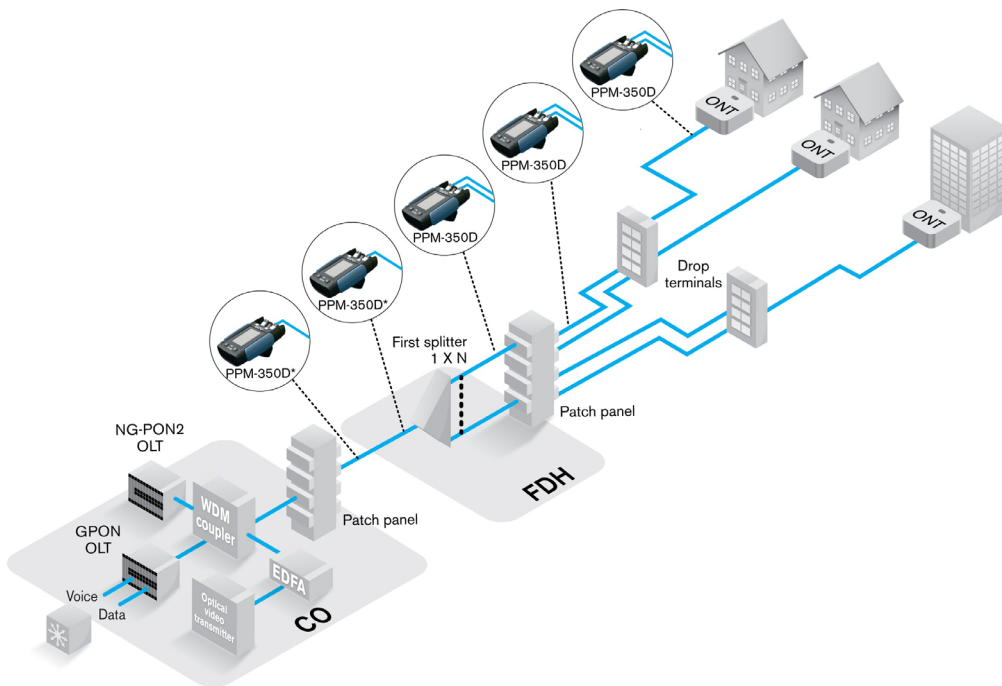

Technical Specifications

To obtain this product's technical specifications, visit the EXFO Web site at www.exfo.com.

Conventions

Before using the product described in this guide, you should understand the following conventions:



WARNING

Indicates a potentially hazardous situation which, if not avoided, could result in *death or serious injury*. Do not proceed unless you understand and meet the required conditions.



CAUTION

Indicates a potentially hazardous situation which, if not avoided, may result in *minor or moderate injury*. Do not proceed unless you understand and meet the required conditions.



CAUTION

Indicates a potentially hazardous situation which, if not avoided, may result in *component damage*. Do not proceed unless you understand and meet the required conditions.



IMPORTANT

Refers to information about this product you should not overlook.

2 **Safety Information**



WARNING

Do not install or terminate fibers while a light source is active. Never look directly into a live fiber and ensure that your eyes are protected at all times.



WARNING

The use of controls, adjustments and procedures, namely for operation and maintenance, other than those specified herein may result in hazardous radiation exposure or impair the protection provided by this unit.



WARNING

If the equipment is used in a manner not specified by the manufacturer, the protection provided by the equipment may be impaired.



WARNING

Use only accessories designed for your unit and approved by EXFO. For a complete list of accessories available for your unit, refer to its technical specifications or contact EXFO.



IMPORTANT



When you see the following symbol on your unit , make sure that you refer to the instructions provided in your user documentation. Ensure that you understand and meet the required conditions before using your product.



IMPORTANT



When you see the following symbol on your unit , it indicates that the unit is equipped with a laser source, or that it can be used with instruments equipped with a laser source. These instruments include, but are not limited to, modules and external optical units.













IMPORTANT

Other safety instructions relevant for your product are located throughout this documentation, depending on the action to perform. Make sure to read them carefully when they apply to your situation.

Other Safety Symbols on Your Unit

One or more of the following symbols may also appear on your unit.

Symbol	Meaning
	Direct current
	Alternating current
	The unit is equipped with an earth (ground) terminal.
	The unit is equipped with a protective conductor terminal.
	The unit is equipped with a frame or chassis terminal.
	On (Power)
	Off (Power)
 OR 	On/off (Power)
	Fuse

Safety Information

Laser Safety Information (Models with VFL)

Laser Safety Information (Models with VFL)

Your instrument is a Class 2 laser product.

It is in compliance with standards IEC 60825-1: 2007 and 21 CFR 1040.10, except for deviations pursuant to Laser Notice No. 50, dated June 24, 2007. It is also in compliance with IEC 60825-1: 2014. Laser radiation is emitted at the output port.

The following label(s) indicate that the product contains a Class 2 source:

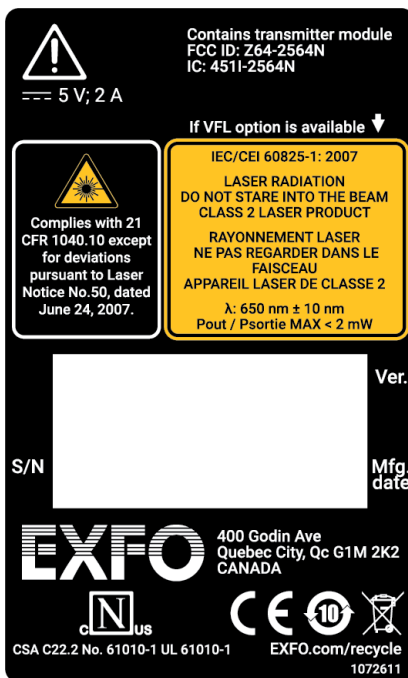

← Affixed to the back of the unit.

Electrical Safety Information



WARNING

If you need to ensure that the unit is completely turned off, disconnect the power cable and remove the battery. For more information on how to remove the battery, see the section about replacing the battery in this user documentation.



WARNING

- Use the external power supply (adapter/charger) indoors only.
- Never connect the unit to the AC mains (with the adapter/charger) when it is used outdoors.
- Use only the listed and certified AC adapter/charger provided by EXFO with your unit. It provides reinforced insulation between primary and secondary, and is suitably rated for the country where the unit is sold.
- Operation of any electrical instrument around flammable gases or fumes constitutes a major safety hazard.
- To avoid electrical shock, do not operate the unit if any part of the outer surface (covers, panels, etc.) is damaged.
- Only authorized personnel should carry out adjustments, maintenance or repair of opened units under voltage. A person qualified in first aid must also be present. Do not replace any components while the power cable and battery are connected.
- Unless otherwise specified, all interfaces are intended for connection to Safety Extra Low Voltage (SELV) circuits only.
- Capacitors inside the unit may be charged even if the unit has been disconnected from its electrical supply.

Safety Information

Electrical Safety Information



CAUTION

When you use the unit outdoors, ensure that it is protected from liquids, dust, direct sunlight, precipitation, and full wind pressure.



CAUTION

Position the unit so that the air can circulate freely around it.



CAUTION

The use of voltages higher than those indicated on the label affixed to your unit may damage the unit.

Equipment Ratings	
Temperature	
➤ Operation	<ul style="list-style-type: none">➤ Unit powered by batteries: 0 °C to 50 °C (32 °F to 122 °F)➤ Unit connected to USB adapter: 0 °C to 40 °C (32 °F to 104 °F)
➤ Storage	<ul style="list-style-type: none">➤ Unit without batteries: -40 °C to 70 °C (-40 °F to 158 °F)➤ Unit with batteries: -20 °C to 60 °C (-4 °F to 140 °F)
Relative humidity ^a	<ul style="list-style-type: none">➤ Unit powered by batteries: ≤ 95 % non-condensing➤ Unit connected to USB adapter: 10 % to 90 % non-condensing
Maximum operation altitude	<ul style="list-style-type: none">➤ 2000 m (6562 ft) (unit connected to USB adapter)➤ 5000 m (16405 ft) (unit operated from batteries)

Equipment Ratings	
Pollution degree	<ul style="list-style-type: none">▶ 2 (unit connected to USB adapter)▶ 3 (unit operated by batteries)^b
Overvoltage category	<ul style="list-style-type: none">▶ Unit: I▶ AC/USB adapter: II
Input power ^c	<ul style="list-style-type: none">▶ Unit:  5 Vdc; 2.0 A▶ USB adapter: \sim 100 - 240 Vac; 50/60 Hz; 1.0 A
Measurement category	<ul style="list-style-type: none">▶ Not rated for measurement categories II, III, or IV

- a. Measured in 0 °C to 31 °C (32 °F to 87.8 °F) range, decreasing linearly to 50 % at 40 °C (104 °F).
- b. Equipment must be normally protected against exposure to direct sunlight, precipitation and full wind pressure.
- c. Not exceeding \pm 10 % of the nominal voltage.

3 Getting Started with Your PON Power Meter

Turning the Unit On and Off

When you turn the PON Power Meter off, it saves the current settings, which include the measurement mode and active test configuration.

Note: When the unit is turned on, offset nulling values are returned to factory settings and the ONT CW mode is switched to OFF.

To turn the unit on:

Press . The unit displays **EXFO** for a few seconds and then the measurement page along with the settings saved before the unit was powered off. You may use your unit immediately under normal conditions.

To turn the unit off:

Hold down  a few seconds. The unit saves the current settings automatically.

Physical Interface



Getting Started with Your PON Power Meter

Installing the EXFO Universal Interface (EUI)

Installing the EXFO Universal Interface (EUI)

The EUI fixed baseplate is available for connectors with angled (APC) or non-angled (UPC) polishing. The type of border around the baseplate indicates which type of connector it is designed for.

Green border
indicates APC
option

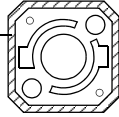

Bare metal, or a
black or dark gray
border indicates
UPC option

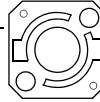

To install an EUI connector adapter onto the EUI baseplate:

1. Hold the EUI connector adapter so the dust cap opens downwards.

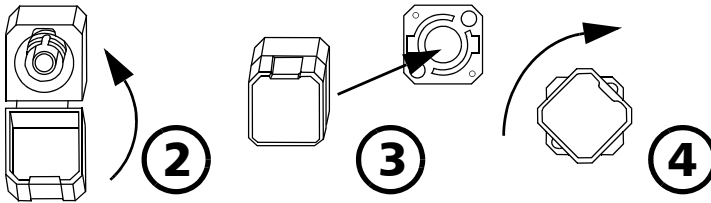

2. Close the dust cap in order to hold the connector adapter more firmly.
3. Insert the connector adapter into the baseplate.
4. While pushing firmly, turn the connector adapter clockwise on the baseplate to lock it in place.

Cleaning and Connecting Optical Fibers



IMPORTANT

To ensure maximum power and to avoid erroneous readings:

- Always inspect fiber ends and make sure that they are clean as explained below before inserting them into the port. EXFO is not responsible for damage or errors caused by bad fiber cleaning or handling.
- Ensure that your patchcord has appropriate connectors. Joining mismatched connectors will damage the ferrules.

To connect the fiber-optic cable to the port:

- 1.** Inspect the fiber using a fiber inspection probe. If the fiber is clean, proceed to connecting it to the port. If the fiber is dirty, clean it as explained below.
- 2.** Clean the fiber ends as follows:
 - 2a.** Gently wipe the fiber end with a lint-free swab dipped in optical-grade liquid cleaner.
 - 2b.** Use a dry swab to dry the connector completely.
 - 2c.** Visually inspect the fiber end to ensure its cleanliness.

Getting Started with Your PON Power Meter

Cleaning and Connecting Optical Fibers

3. Carefully align the connector and port to prevent the fiber end from touching the outside of the port or rubbing against other surfaces.

If your connector features a key, ensure that it is fully fitted into the port's corresponding notch.

4. Push the connector in so that the fiber-optic cable is firmly in place, thus ensuring adequate contact.

If your connector features a screw sleeve, tighten the connector enough to firmly maintain the fiber in place. Do not overtighten, as this will damage the fiber and the port.

Note: *If your fiber-optic cable is not properly aligned and/or connected, you will notice heavy loss and reflection.*

EXFO uses good quality connectors in compliance with EIA-455-21A standards.

To keep connectors clean and in good condition, EXFO strongly recommends inspecting them with a fiber inspection probe before connecting them. Failure to do so will result in permanent damage to the connectors and degradation in measurements.

Menu

The PPM-350D menu consists of the following:

- VFL control
- Config selection
- Parameters

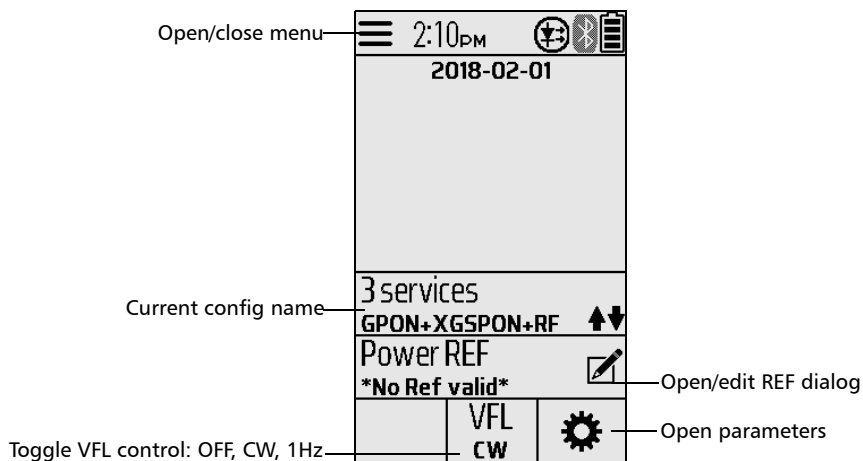

Setting Parameters

To view or edit the unit's parameters:

From the menu screen, tap .





Annotations for the parameters menu:

- SET DATE & TIME: points to the top header area.
- Toggle on/off: points to the Bluetooth, Sound on touch, and ONT CW toggle switches.
- Disable, or increase/decrease the time duration before the unit automatically powers off: 2, 5 (default), 15, or 30 min: points to the Auto-Off section.
- Exit parameters: points to the back arrow at the bottom left.

Date and Time

To set the date and time:

1. From the parameters screen, tap .
2. Tap to highlight the value you want to edit or use the left/right arrows to navigate and highlight the value to be changed.
3. Tap the up/down arrows to increase/decrease the desired value.
4. Tap the **24H AM/PM** to toggle between time formats.
5. Tap **OK** to confirm the change or  to cancel any changes and exit.

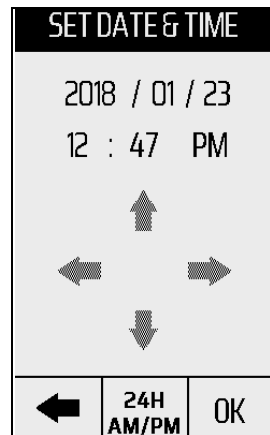

SET DATE & TIME

2018 / 01 / 23

12 : 47 PM

Navigation arrows: up, down, left, right.

Bottom bar:  24H AM/PM OK

Nulling Electrical Offsets

Temperature and humidity variations affect the performance of electronic circuits and optical detectors. Nulling the electrical offsets eliminates these effects. *Your unit has been designed not to require offset nulling under normal operation*, but you should perform it whenever environmental conditions change significantly or when measuring very low power values.



IMPORTANT

If light reaches the detector when nulling offsets, Light Detected appears on the display and the nulling is not performed. You will need to tap Retry or Cancel to return to the previous display.

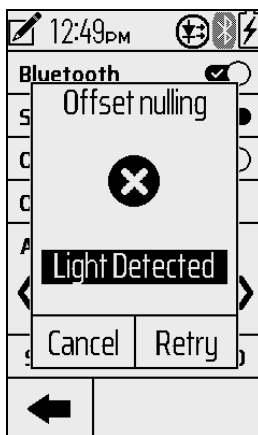

Note: *Factory-defined values will be reinstated when you turn the unit off.*

Getting Started with Your PON Power Meter







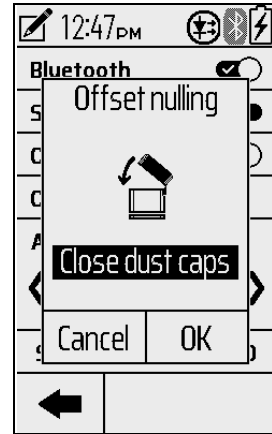

Measurement Status and Icons

To perform an offset nulling:

1. From the menu screen, tap .
2. In the list of tools, tap **Offset nulling...**
3. **Close dust caps** and tap **OK**. If *no Light Detected*, the unit displays a check mark, indicating the nulling is completed.
4. Tap **OK** to return to the tools list screen.



Measurement Status and Icons

Active Layers and Test Results Navigation		Inactive Layers (not considered for Global Pass/Fail)	
Button	Description	Button	Description
	Done - no threshold (measurement exists)		Done (Inactive upstream)
	Not done (no measurement)		
	Pass		Pass
	Fail		Fail
	Lock - during burst detection		

Layer Examples:

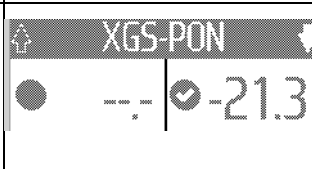
Active Layer	 <p>The screenshot shows a dark interface with the text "GPON" at the top. Below it, two power values are displayed: "-1.5" and "-22.8". Both values have a white checkmark icon to their left, indicating they are active.</p>
Inactive Layer ^a	 <p>The screenshot shows a greyed-out interface with the text "XGS-PON" at the top. Below it, a power value "-21.3" is displayed with a white checkmark icon to its left. To the left of the value, there is a grey circle and a dashed line, indicating that this layer is inactive.</p>

- a. In a multi-layer PON, all downstream wavelengths from the OLT reach all ONTs. At service activation, when testing on the ONT side (any test point after last splitter), only one upstream wavelength is active, corresponding to the actual service activated.

4 Test Configuration

Your PPM-350D PON Power Meter has been configured by EXFO with predefined information:

- Examples of test configurations that you use in FTTx mode.
- A test configuration consists of PON layer selections with their class and speeds. Custom thresholds values can also be set for each PON layer, depending on your unit. For each wavelength, you can select the pass and fail criteria.
- Test configuration parameters are as follows:
 - Location (ONT, OLT)
 - Measurement type (dB/dBm)
 - Direction (US/DS)

You may customize these parameters using FastReporter 3. Refer to the FastReporter 3 user guide for more information.

Configuration Selection

Test configurations are displayed 5 to a page.

To open, view, and select a configuration:

1. In the menu panel, tap on an existing test configuration to see the **Configuration list**.
2. If there is more than 1 page, swipe left to view the other pages.
3. Tap on a test configuration and tap OK to confirm your selection.
4. To cancel and return to the menu panel, tap ←.

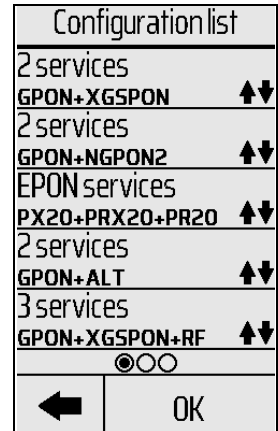

5 **Performing FTTx Measurements**

The FTTx mode can be used during service activation (at ONT) or to troubleshoot passive optical networks (at ONT, drop terminal, fiber distribution hub or CO). You can measure two or three wavelengths simultaneously, depending on the configuration of the unit.

Thresholds

Selecting a Threshold Set

You can select which threshold set will be used to determine the Pass/Fail status. Your unit can contain many threshold sets through configurations, but only one set can be selected at a time.

Depending on the model, a configuration comprises threshold sets for 5 wavelengths (1270/1310 nm for upstream and 1490/1577/1550 nm for downstream), each of them having specific threshold values for pass, warning, and fail.

Thresholds can be viewed directly on your unit. To modify them, use FastReporter 3. For more information, refer to the FastReporter 3 user guide.

Performing FTTx Measurements

Thresholds

Threshold View (Margin Meter)

To view the margin meter:

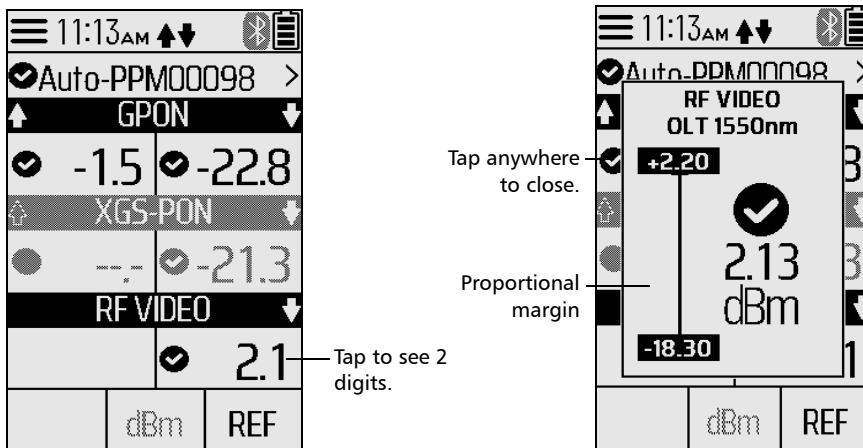

Performing a Measurement

At startup, the unit uses the same configuration that was used during the last test session.

- Pass/Fail status is indicated directly (screen and LEDs). Status is determined according to the current threshold set (see *Selecting a Threshold Set* on page 31).
- If no thresholds are present in the configuration in use, only the power levels are shown and LEDs are off.

Measurements on the ONT side are designed for burst measurements coming from ONTs that respect known standards of duration. For CW measurements, activate the ONT CW option as shown in *Setting Parameters* on page 24.

To test in Pass/Fail or Normal mode:

1. Inspect your fibers and clean them properly if needed (see *Cleaning and Connecting Optical Fibers* on page 21 for details).
2. Connect as shown:

Test at the premises

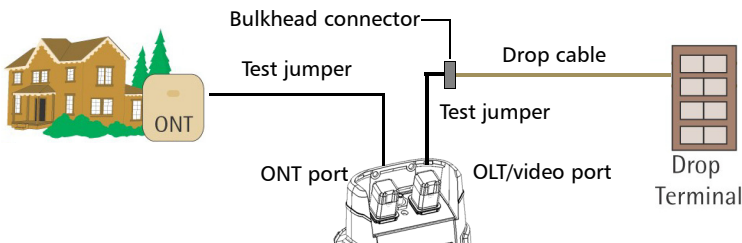

Performing FTTx Measurements

Performing a Measurement

Test at the drop terminal

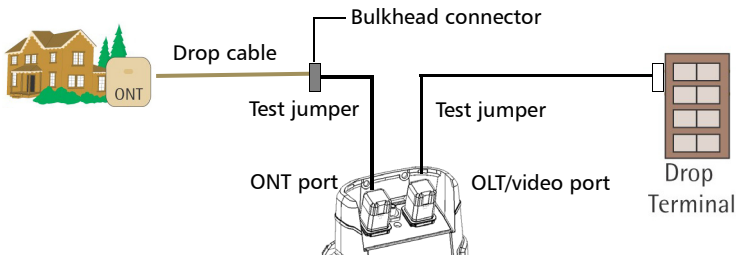

Test at the fiber distribution hub (FDH)

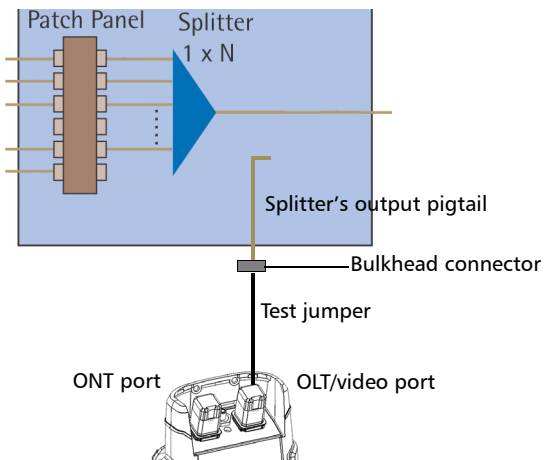

3. Turn unit on.
4. Select appropriate test configuration.

Note: When testing on F1 (between the CO and Splitter), select downstream only.

Results are now available.

Reference Dialog

PON loss can be tested using downstream signals at different points of connection. A reference of source power can be acquired at the CO or entered manually in the unit.

Edit Reference

To edit a reference:

1. Tap **REF**.
2. Tap on a number in the reference column to edit the value. In the report, the REF will be tagged as “manually edited”.

Working in dB (Loss) Mode

To work in dB (loss) mode (downstream only):

- 1.** In the menu panel, tap on a test configuration to see the **Configuration list**.
- 2.** Tap **Power REF** to perform a reference (only selected PON layers are referenced).

Tap **TAKE REF**.

- 3.** Tap the arrow to return to the menu page, then the measurement page, and perform a loss measurement. Values are in dB.

Tap **dB** to toggle between **dBm** and **dB**.

You can manually edit the REF values if for example the Power REF was measured by someone else, at the other end of the link. See *Edit Reference* on page 35 for more information.

6 *Managing Test Results*

You can save up to 3500 results in your unit. It is also possible to delete one or all measurements from your unit.

- Measurements are synced with smart app when a Bluetooth connection is maintained.
- After a measurement is deleted, its ID is available but not immediately accessible for a new measurement. The unit will compress memory at boot-up after more than 10 % of the memory has been deleted. All available space will become ready at this point.

Using Bluetooth, you can also transfer your data from your unit to a smart device.

Storing Data



The PPM-350D generates measurement IDs that are not configurable (auto-incremental starting from the last ID). It saves all measurements stored in a sequence, in a single file/folder which can be read by the smart app. You can also clear all measurements yourself.

Managing Test Results

Results Navigator

Results Navigator

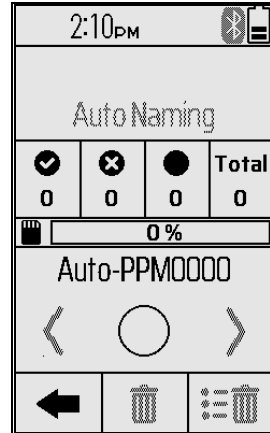

Test data can be viewed and managed from the measurements page by providing the following features:

- View measurements saved (Auto)
- The number of pass /fail 
- The number of non-status measurements 
- ID of the next available measurement data
- Status of the selected measurement
- Delete one/all measurements



Note: You can only view the overall status of a measurement, not the details (individual power level or individual pass/fail status).



To navigate test measurements:

1. Tap a results ID to open the measurements page.
2. Tap previous  or next  to navigate to more IDs.

Deleting Data

You can delete unwanted data directly from the unit when viewing your stored data.

To delete data:

1. Tap  to delete the current measurement.
2. Tap   to clear all results.

7 Identifying Fiber Faults Visually

Note: This feature is available only if your unit is equipped with a VFL port.

The VFL (visual fault locator) helps you identify bends, faulty connectors, splices, and other causes of signal loss.

From its dedicated port, the VFL emits a red signal which becomes visible at the location of a fault on the fiber. This signal can be continuous (default) or blinking (1 Hz).

When the VFL is on,  is displayed at the top-right of the screen.

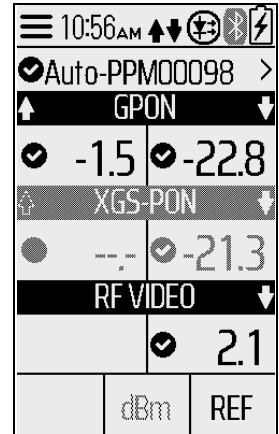

WARNING

When the VFL is active, the VFL port emits visible laser radiation. Avoid exposure and do not stare directly into the beam. Ensure that any unused port is properly protected with a cap.

To activate the VFL and inspect a fiber:

1. Connect the fiber under test to the VFL port (see *Cleaning and Connecting Optical Fibers* on page 21).
2. Tap  to open the menu page.

Identifying Fiber Faults Visually

3. Tap **VFL** from the menu to toggle between **CW** (continuous signal) and **1Hz** (blinking signal).
4. Without looking directly into the beam, examine the fiber. If light is coming out of the rubber jacket or on the side of the ferrule, the fiber is defective.
5. Deactivate the VFL by toggling to **OFF**.

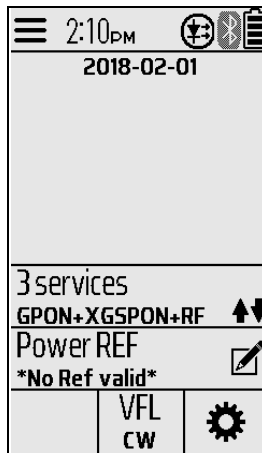

8 **OPM Smart Device**

The EXFO OPM (optical power meter) smart device application is available for iOS in the Apple App Store and for Android devices in Google Play. When the application is synced with your PPM-350D over Bluetooth, it can control all measurements and testing features available within your PPM-350D. The OPM application enables the following advanced/additional features:

- Import/Export test configurations from an email, a cloud service (DropBox, OneDrive, iCloud) or instant messaging application
- Delete/Select test configurations
- Read test configuration details (PON layers, standard, Class and bit rate, Thresholds)
- Push a test configuration to the PPM-350D
- Edit existing measurement names
- Define measurement identifiers for next measurement
- Edit existing measurement identification fields from an existing measurement
- Store a measurement(s) (taken from PPM-350D or OPM application)
- Open a saved measurement(s)
- Delete a measurement(s)
- Generate a PDF test report for a measurement
- Share a PDF test report

9 **Maintenance**

To help ensure long, trouble-free operation:

- Always inspect fiber-optic connectors before using them and clean them if necessary.
- Keep the unit free of dust.
- Clean the unit casing and front panel with a cloth slightly dampened with water.
- Store unit at room temperature in a clean and dry area. Keep the unit out of direct sunlight.
- Avoid high humidity or significant temperature fluctuations.
- Avoid unnecessary shocks and vibrations.
- If any liquids are spilled on or into the unit, turn off the power immediately, disconnect from any external power source, remove the batteries and let the unit dry completely.



WARNING

The use of controls, adjustments and procedures, namely for operation and maintenance, other than those specified herein may result in hazardous radiation exposure or impair the protection provided by this unit.

Cleaning EUI Connectors

Regular cleaning of EUI connectors will help maintain optimum performance. There is no need to disassemble the unit.



IMPORTANT

If any damage occurs to internal connectors, the module casing will have to be opened and a new calibration will be required.



WARNING

Looking into the optical connector while the light source is active **WILL** result in permanent eye damage. EXFO strongly recommends to **TURN OFF** the unit before proceeding with the cleaning procedure.

To clean EUI connectors:

1. Remove the EUI from the instrument to expose the connector baseplate and ferrule.

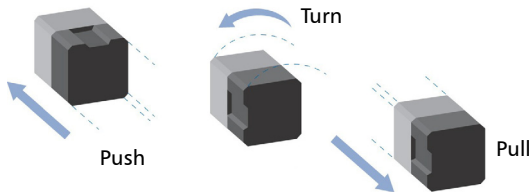

2. Moisten a 2.5 mm cleaning tip with *one drop* of optical-grade liquid cleaner.

3. Slowly insert the cleaning tip into the EUI adapter until it comes out on the other side (a slow clockwise rotating movement may help).

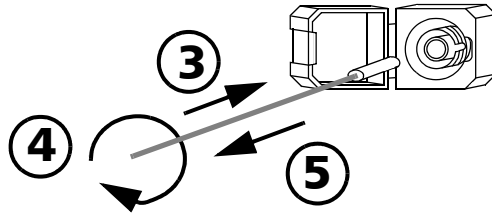

4. Gently turn the cleaning tip one full turn, then continue to turn as you withdraw it.
5. Repeat steps 3 to 4 with a dry cleaning tip.

Note: *Make sure you don't touch the soft end of the cleaning tip.*

6. Clean the ferrule in the connector port as follows:
 - 6a. Deposit *one drop* of optical-grade liquid cleaner on a lint-free wiping cloth.



IMPORTANT

Avoid contact between the tip of the bottle and the wiping cloth, and dry the surface quickly.

- 6b. Gently wipe the connector and ferrule.
- 6c. With a dry lint-free wiping cloth, gently wipe the same surfaces to ensure that the connector and ferrule are perfectly dry.
- 6d. Verify connector surface with a fiber inspection probe (for example, EXFO's FIP).
7. Put the EUI back onto the instrument (push and turn clockwise).
8. Throw out cleaning tips and wiping cloths after one use.

Maintenance

Recharging the Battery

Recharging the Battery

Recharging your batteries is done through the USB Type-C port at the bottom of the unit. Connect the USB cable to the provided AC adapter for optimal recharge time/speed.

Replacing the Battery



WARNING

Your unit uses a smart lithium-ion (Li-Ion) battery with built-in protection that has been especially designed for EXFO. For this reason, you can only replace it with a battery of the same type and model.



WARNING

RISK OF EXPLOSION IF THE BATTERY IS REPLACED BY AN INCORRECT TYPE. DISPOSE OF USED BATTERIES ACCORDING TO THE MANUFACTURER'S INSTRUCTIONS.



WARNING

Do not throw batteries into fire or water and do not short-circuit the battery electrical contacts. Do not disassemble.



IMPORTANT

Recycle or dispose of used batteries properly, in accordance with local regulations. Do not dispose of them in ordinary garbage receptacles. For more information, see the section about recycling and disposal in this user documentation.

To replace the battery:

1. Place the unit face down on a hard surface such as a table.
2. Remove the four screws holding the back panel in place, then remove the back panel completely.

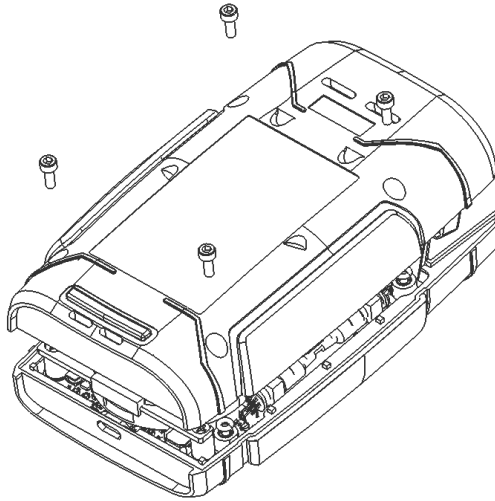

CAUTION

The battery is located close to the optical components of your unit. Make sure that you do not damage them when removing or installing the battery.

Maintenance

Replacing the Battery

3. Disconnect the battery cable and remove the old battery from the unit.

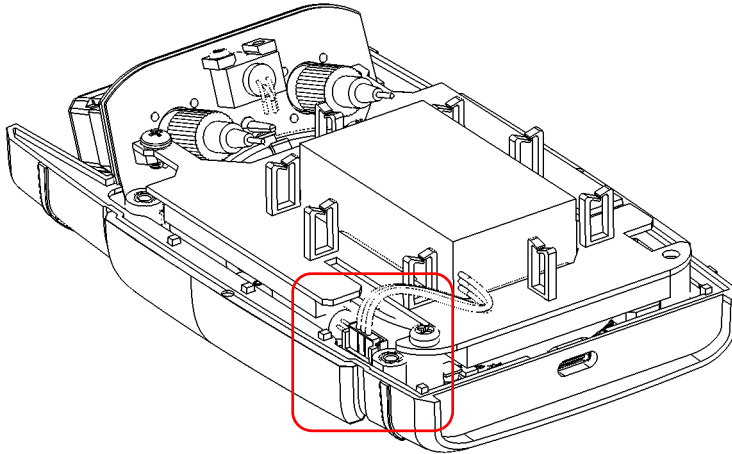

4. Put the new battery into the unit and reconnect its cable.
5. Restore the back panel making sure that the battery cable does not get caught between the panels.
6. Secure the back panel with the screws.

Recalibrating the Unit

EXFO manufacturing and service center calibrations are based on the ISO/IEC 17025 standard (*General Requirements for the Competence of Testing and Calibration Laboratories*). This standard states that calibration documents must not contain a calibration interval and that the user is responsible for determining the re-calibration date according to the actual use of the instrument.

The validity of specifications depends on operating conditions. For example, the calibration validity period can be longer or shorter depending on the intensity of use, environmental conditions and unit maintenance, as well as the specific requirements for your application. All of these elements must be taken into consideration when determining the appropriate calibration interval of this particular EXFO unit.

Under normal use, the recommended interval for your PPM-350D PON Power Meter is: three years.

For newly delivered units, EXFO has determined that the storage of this product for up to six months between calibration and shipment does not affect its performance (EXFO Policy PL-03).

Maintenance

Recalibrating the Unit

To help you with calibration follow-up, EXFO provides a special calibration label that complies with the ISO/IEC 17025 standard and indicates the unit calibration date and provides space to indicate the due date. Unless you have already established a specific calibration interval based on your own empirical data and requirements, EXFO would recommend that the next calibration date be established according to the following equation:

Next calibration date = Date of first usage (if less than six months after the calibration date) + Recommended calibration period (three years)

To ensure that your unit conforms to the published specifications, calibration may be carried out at an EXFO service center or, depending on the product, at one of EXFO's certified service centers. Calibrations at EXFO are performed using standards traceable to national metrology institutes.

Note: *You may have purchased a FlexCare plan that covers calibrations. See the Service and Repairs section of this user documentation for more information on how to contact the service centers and to see if your plan qualifies.*

Recycling and Disposal



This symbol on the product means that you should recycle or dispose of your product (including electric and electronic accessories) properly, in accordance with local regulations. Do not dispose of it in ordinary garbage receptacles.

For complete recycling/disposal information, visit the EXFO Web site at www.exfo.com/recycle.

10 Troubleshooting

Solving Common Problems

Problem	Possible Cause	Solution
Slow charge.	Charger not powerful enough, cable too long or low quality.	Use provided cable and charger.
Unit not charging when plugged in with provided cable and charger.	Battery may be completely depleted.	Press power button while the unit is still plugged in.
ONT power detected when it shouldn't be.	A reflection might be present on the network.	Check for unconnected, damaged, or dirty UPC connectors. Connect, replace, or clean them.
ONT power not detected when there is power.	Signal is continuous or burst is very different from known standards regarding duration and period.	Measurements on the ONT side are designed for burst measurements coming from ONTs that respect known standards of duration and period. For CW measurements, activate the ONT CW option as shown in <i>Setting Parameters</i> on page 24.

Troubleshooting

Contacting the Technical Support Group

Contacting the Technical Support Group

To obtain after-sales service or technical support for this product, contact EXFO at one of the following numbers. The Technical Support Group is available to take your calls from Monday to Friday, 8:00 a.m. to 7:00 p.m. (Eastern Time in North America).

Technical Support Group

400 Godin Avenue
Quebec (Quebec) G1M 2K2
CANADA

1 866 683-0155 (USA and Canada)
Tel.: 1 418 683-5498
Fax: 1 418 683-9224
support@exfo.com



For detailed information about technical support, and for a list of other worldwide locations, visit the EXFO Web site at www.exfo.com.

If you have comments or suggestions about this user documentation, you can send them to customer.feedback.manual@exfo.com.

To accelerate the process, please have information such as the name and the serial number (see the product identification label), as well as a description of your problem, close at hand.

You may also be requested to provide the embedded software's version numbers.

To display the embedded software version:

1. Hold down THRESHOLD/ λ and press  at the same time. The unit displays the main software version.
2. Press  to return to your previous mode.

Transportation

Maintain a temperature range within specifications when transporting the unit. Transportation damage can occur from improper handling. The following steps are recommended to minimize the possibility of damage:

- Pack the unit in its original packing material when shipping.
- Avoid high humidity or large temperature fluctuations.
- Keep the unit out of direct sunlight.
- Avoid unnecessary shocks and vibrations.

11 Warranty

General Information

EXFO Inc. (EXFO) warrants this equipment against defects in material and workmanship for a period of three years from the date of original shipment. EXFO also warrants that this equipment will meet applicable specifications under normal use.

During the warranty period, EXFO will, at its discretion, repair, replace, or issue credit for any defective product, as well as verify and adjust the product free of charge should the equipment need to be repaired or if the original calibration is erroneous. If the equipment is sent back for verification of calibration during the warranty period and found to meet all published specifications, EXFO will charge standard calibration fees.



IMPORTANT

The warranty can become null and void if:

- unit has been tampered with, repaired, or worked upon by unauthorized individuals or non-EXFO personnel.
- warranty sticker has been removed.
- case screws, other than those specified in this guide, have been removed.
- case has been opened, other than as explained in this guide.
- unit serial number has been altered, erased, or removed.
- unit has been misused, neglected, or damaged by accident.

THIS WARRANTY IS IN LIEU OF ALL OTHER WARRANTIES EXPRESSED, IMPLIED, OR STATUTORY, INCLUDING, BUT NOT LIMITED TO, THE IMPLIED WARRANTIES OF MERCHANTABILITY AND FITNESS FOR A PARTICULAR PURPOSE. IN NO EVENT SHALL EXFO BE LIABLE FOR SPECIAL, INCIDENTAL, OR CONSEQUENTIAL DAMAGES.

Warranty

Liability

Liability

EXFO shall not be liable for damages resulting from the use of the product, nor shall be responsible for any failure in the performance of other items to which the product is connected or the operation of any system of which the product may be a part.

EXFO shall not be liable for damages resulting from improper usage or unauthorized modification of the product, its accompanying accessories and software.

Exclusions

EXFO reserves the right to make changes in the design or construction of any of its products at any time without incurring obligation to make any changes whatsoever on units purchased. Accessories, including but not limited to fuses, pilot lamps, batteries and universal interfaces (EUI) used with EXFO products are not covered by this warranty.

This warranty excludes failure resulting from: improper use or installation, normal wear and tear, accident, abuse, neglect, fire, water, lightning or other acts of nature, causes external to the product or other factors beyond the control of EXFO.



IMPORTANT

In the case of products equipped with optical connectors, EXFO will charge a fee for replacing connectors that were damaged due to misuse or bad cleaning.

Certification

EXFO certifies that this equipment met its published specifications at the time of shipment from the factory.

Service and Repairs

EXFO commits to providing product service and repair for five years following the date of purchase.

To send any equipment for service or repair:

1. Call one of EXFO's authorized service centers (see *EXFO Service Centers Worldwide* on page 61). Support personnel will determine if the equipment requires service, repair, or calibration.
2. If equipment must be returned to EXFO or an authorized service center, support personnel will issue a Return Merchandise Authorization (RMA) number and provide an address for return.
3. If possible, back up your data before sending the unit for repair.
4. Pack the equipment in its original shipping material. Be sure to include a statement or report fully detailing the defect and the conditions under which it was observed.
5. Return the equipment, prepaid, to the address given to you by support personnel. Be sure to write the RMA number on the shipping slip. *EXFO will refuse and return any package that does not bear an RMA number.*

Note: *A test setup fee will apply to any returned unit that, after test, is found to meet the applicable specifications.*

After repair, the equipment will be returned with a repair report. If the equipment is not under warranty, you will be invoiced for the cost appearing on this report. EXFO will pay return-to-customer shipping costs for equipment under warranty. Shipping insurance is at your expense.

Routine recalibration is not included in any of the warranty plans. Since calibrations/verifications are not covered by the basic or extended warranties, you may elect to purchase FlexCare Calibration/Verification Packages for a definite period of time. Contact an authorized service center (see *EXFO Service Centers Worldwide* on page 61).

EXFO Service Centers Worldwide

If your product requires servicing, contact your nearest authorized service center.

EXFO Headquarters Service Center

400 Godin Avenue
Quebec (Quebec) G1M 2K2
CANADA

1 866 683-0155 (USA and Canada)
Tel.: 1 418 683-5498
Fax: 1 418 683-9224
support@exfo.com

EXFO Europe Service Center

Winchester House, School Lane
Chandlers Ford, Hampshire S053 4DG
ENGLAND

Tel.: +44 2380 246800
Fax: +44 2380 246801
support.europe@exfo.com

EXFO Telecom Equipment (Shenzhen) Ltd.

3rd Floor, Building C,
FuNing Hi-Tech Industrial Park, No. 71-3,
Xintian Avenue,
Fuhai, Bao'An District,
Shenzhen, China, 518103

Tel: +86 (755) 2955 3100
Fax: +86 (755) 2955 3101
support.asia@exfo.com

To view EXFO's network of partner-operated Certified Service Centers nearest you, please consult EXFO's corporate website for the complete list of service partners:

<http://www.exfo.com/support/services/instrument-services/exfo-service-centers>.

Index

A	
AC requirements	16
adapter	15
after-sales service	54
alkaline battery. <i>see</i> battery	
B	
battery	
description	7
indicator	7
rechargeable	3
replace	47
type allowed	46
Bluetooth®	1, 2, 37, 41
frequency band data	vi
C	
cancelling dark current effects	25
capacitors	15
caution	
of personal hazard	9
of product hazard	9
certification information	v
charger	15
circuit performance	25
cleaning	
EUI connectors	44
fiber ends	21
front panel	43
connectors, cleaning	44
conventions, safety	9
customer service	60
D	
dark current effects, eliminating	25
date and time	24
disposable battery. <i>see</i> battery	
E	
electronic offsets, eliminating	25
eliminating offsets/dark current	25
equipment returns	60
EUI	
baseplate	20
connector adapter	20
connectors, cleaning	44
dust cap	20
EXFO universal interface. <i>see</i> EUI	
external power supply	15
F	
fiber ends, cleaning	21
frequency, Bluetooth®	vi
front panel, cleaning	43
I	
identification label	54
indoor use	15
installing	
unit	16
L	
label, identification	54
M	
maintenance	
EUI connectors	44
front panel	43
general information	43
margin meter	32
mode	
dB (loss)	36
FTTx	29, 31
loss	7
measurement	19
power	7

remote reference	8	specifications, product	8
spy	2	storage requirements	43
modulation, VFL	39	symbols, safety	9
mounting EUI connector adapter	20		
		T	
N		technical specifications	8
null measurement, performing	25	technical support	54
nulling offsets	25	temperature for storage	43
		test tools	
O		visual fault locator	39
optical detector performance	25	touchscreen	2
		transportation requirements	43, 55
		U	
P		unit	
performing null measurement	25	installing	16
power		repairing	15
supply	15	ventilation	16
power sources			
description	7	V	
<i>see also</i> AC adapter/charger		ventilation	16
<i>see also</i> battery		VFL	
product		operation and display	39
identification label	54	performing a test	39
specifications	8	signal modulation	39
R		W	
reference, zero power	25	warranty	
repairing unit	15	certification	59
replaceable battery. <i>see</i> battery		exclusions	59
return merchandise authorization (RMA)	60	general	57
		liability	58
S		null and void	57
safety			
caution	9	Z	
conventions	9	zero-power reference	25
warning	9		
service and repairs	60		
service centers	61		
shipping to EXFO	60		
smart app	1, 3, 37, 41		

CHINESE REGULATION ON RESTRICTION OF HAZARDOUS SUBSTANCES (RoHS)
中国关于有害物质限制的规定

NAMES AND CONTENTS OF THE TOXIC OR HAZARDOUS SUBSTANCES OR ELEMENTS
CONTAINED IN THIS EXFO PRODUCT
包含在本 EXFO 产品中的有毒有害物质或元素的名称及含量

Part Name 部件名称	Lead 铅 (Pb)	Mercury 汞 (Hg)	Cadmium 镉 (Cd)	Hexavalent Chromium 六价铬 (Cr(VI))	Polybrominated biphenyls 多溴联苯 (PBB)	Polybrominated diphenyl ethers 多溴二苯醚 (PBDE)
Enclosure 外壳	O	O	O	O	O	O
Electronic and electrical sub-assembly 电子和电气组件	X	O	X	O	X	X
Optical sub-assembly ^a 光学组件 ^a	X	O	O	O	O	O
Mechanical sub-assembly ^a 机械组件 ^a	O	O	O	O	O	O

Note:

注:

This table is prepared in accordance with the provisions of SJ/T 11364.

本表依据 SJ/T 11364 的规定编制。

O: Indicates that said hazardous substance contained in all of the homogeneous materials for this part is below the limit requirement of GB/T 26572.

O: 表示该有害物质在该部件所有均质材料中的含量均在 GB/T 26572 标准规定的限量要求以下。

X: indicates that said hazardous substance contained in at least one of the homogeneous materials used for this part is above the limit requirement of GB/T 26572. Due to the limitations in current technologies, parts with the "X" mark cannot eliminate hazardous substances.



X: 表示该有害物质至少在该部件的某一均质材料中的含量超出 GB/T 26572 标准规定的限量要求。

标记 "X" 的部件, 皆因全球技术发展水平限制而无法实现有害物质的替代。

a. If applicable.

如果适用。

MARKING REQUIREMENTS
标注要求

Product 产品	Environmental protection use period (years) 环境保护使用期限 (年)	Logo 标志
This EXFO product 本 EXFO 产品	10	
Battery ^a 电池	5	

a. If applicable.
如果适用。

P/N: 1072347

www.EXFO.com · info@exfo.com

CORPORATE HEADQUARTERS	400 Godin Avenue	Quebec (Quebec) G1M 2K2 CANADA Tel.: 1 418 683-0211 · Fax: 1 418 683-2170
EXFO AMERICA	3400 Waterview Parkway Suite 100	Richardson, TX 75080 USA Tel.: 1 972-761-9271 · Fax: 1 972-761-9067
EXFO EUROPE	Winchester House, School Lane	Chandlers Ford, Hampshire S053 4DG ENGLAND Tel.: +44 2380 246 800 · Fax: +44 2380 246 801
EXFO ASIA-PACIFIC	62 Ubi Road 1, #09-01/02 Oxley Bizhub 2	SINGAPORE 408734 Tel.: +65 6333 8241 · Fax: +65 6333 8242
EXFO CHINA	Beijing Global Trade Center, Tower C, Room 1207, 36 North Third Ring Road East, Dongcheng District	Beijing 100013 P. R. CHINA Tel.: +86 (10) 5825 7755 · Fax: +86 (10) 5825 7722
EXFO SERVICE ASSURANCE	250 Apollo Drive	Chelmsford MA, 01824 USA Tel.: 1 978 367-5600 · Fax: 1 978 367-5700
EXFO FINLAND	Elektroniikkatie 2	FI-90590 Oulu, FINLAND Tel.: +358 (0) 403 010 300 · Fax: +358 (0) 8 564 5203
TOLL-FREE	(USA and Canada)	1 800 663-3936

© 2018 EXFO Inc. All rights reserved.
Printed in Canada (2018-02)

