

# OSICS Multifunction Platform

## 8-Channel Modular Platform

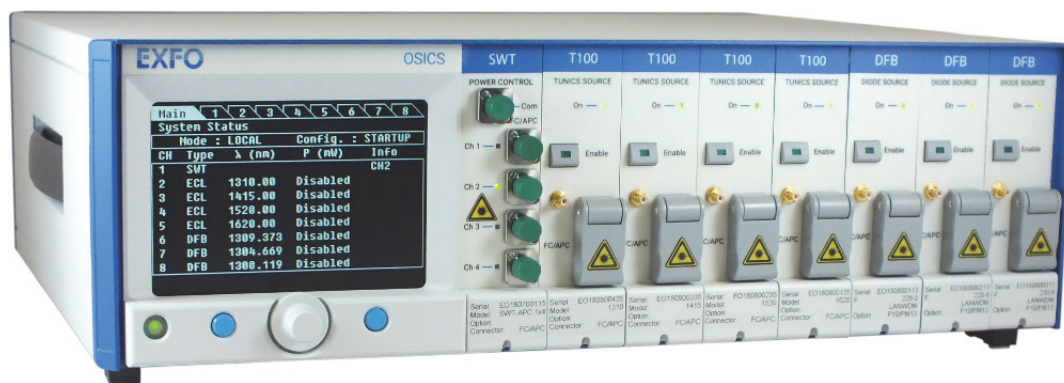

## User Guide



# About This Guide

**Subject** This document explains how to install, set-up and use the OSICS multifunction modular platform composed of the OSICS Mainframe and all the available OSICS pluggable modules.

**Application** Information in this document applies to the OSICS Mainframe version 3.06 and the following versions of OSICS modules:

- OSICS ATN v. 1.07 and higher versions
- OSICS BKR v. 1.07 and higher versions
- OSICS DFB v. 2.38 and higher versions
- OSICS SLD v. 1.03 and higher versions
- OSICS SWT v. 1.07 and higher versions
- OSICS SWT-APC v. 1.13 and higher versions
- OSICS T100 v. 3.05 and higher versions

**Intended Readers** Users of this guide must be familiar with fiber optic technology.

**Date** 31 January 2020

**User Guide Reference** OSICS\_UG\_3v4.0

## Typographical Conventions

**bold** Identifies interface objects such as menu names, labels, buttons and icons.

*italic* Identifies references to other sections or other guides.

`monospace` Identifies portions of program codes, command lines, or messages displayed in command windows.

## Symbols



### Important

Identifies important information to which you must pay particular attention.



### Warning

Indicates a potentially hazardous situation which, if not avoided, could result in death or serious injury. Do not proceed unless you understand and meet the required conditions.



### Caution

Indicates a potentially hazardous situation which, if not avoided, may result in component damage. Do not proceed unless you understand and meet the required conditions.

**Copyright**

Copyright © 2012–2020 EXFO Inc. All rights reserved. No part of this publication may be reproduced, stored in a retrieval system or transmitted in any form, be it electronically, mechanically, or by any other means such as photocopying, recording or otherwise, without the prior written permission of EXFO Inc.(EXFO).

Information provided by EXFO is believed to be accurate and reliable. However, no responsibility is assumed by EXFO for its use nor for any infringements of patents or other rights of third parties that may result from its use. No license is granted by implication or otherwise under any patent rights of EXFO.

EXFO's Commerce And Government Entities (CAGE) code under the North Atlantic Treaty Organization (NATO) is 0L8C3.

The information contained in this publication is subject to change without notice.

**Product Warranty and Limitation of Warranty**

For detailed information about the sales terms and conditions, visit the EXFO web site at [www.exfo.com/how-to-buy/sales-terms-conditions](http://www.exfo.com/how-to-buy/sales-terms-conditions)

**Contact Information**

To obtain after-sales service or technical support for this product, contact EXFO at one of the following numbers.

**Technical Support Group**

400 Godin Avenue  
Quebec (Quebec) G1M 2K2  
CANADA

Tel. USA and Canada: 1 866 683-0155  
Fax: 1 418 683-9224  
E-mail: [support@exfo.com](mailto:support@exfo.com)

For detailed information about technical support and for a list of other worldwide locations, visit the EXFO web site at [www.EXFO.com/support](http://www.EXFO.com/support)

To accelerate the process, please have information such as the name and the serial number (see the product identification label), as well as a description of your problem, close at hand.

# Table of Contents

<b>About This Guide .....</b>	<b>3</b>
<b>Table of Contents .....</b>	<b>5</b>
<b>Important Safety Information for Your Product.....</b>	<b>11</b>
<b>1. Product Presentation .....</b>	<b>15</b>
1.1 Product Features.....	15
1.2 OSICS Mainframe Technical Specifications .....	16
1.3 Product Overview .....	17
1.3.1 OSICS Front Panel.....	17
1.3.2 OSICS Rear Panel.....	18
1.3.3 OSICS Information and Warning Markings .....	19
<b>2. Installing and Connecting the OSICS Multifunction Platform .....</b>	<b>21</b>
2.1 Unpacking and Installing the OSICS Mainframe .....	21
2.2 Connecting the OSICS Mainframe to a Power Source .....	22
2.3 Handling OSICS Modules Into the OSICS Mainframe.....	23
2.3.1 Installing an OSICS Module Into the OSICS Mainframe .....	23
2.3.2 Removing an OSICS Module From the OSICS Mainframe .....	25
2.4 Connecting Optical Devices to OSICS Modules.....	26
2.5 Installing the Remote Interlock .....	27
<b>3. Turning On/Off and Initializing the OSICS Multifunction Platform .....</b>	<b>29</b>
3.1 Turning on the OSICS Multifunction Platform and Accessing the System Status Screen.....	29
3.2 Accessing the OSICS Setup Menus .....	33
3.3 Checking the OSICS Version .....	34
3.4 Modifying the OSICS Mainframe Password.....	35
3.5 Turning Off the OSICS Multifunction Platform.....	36
<b>4. Controlling the Optical Output of all OSICS Modules Simultaneously .....</b>	<b>37</b>
4.1 Enabling/Disabling the Light Source of All Modules .....	37
4.2 Configuring the Optical Output Power of All Modules.....	38
4.2.1 Selecting the Power Unit for All Installed Modules .....	38
4.2.2 Setting the Optical Output Power of All Installed Modules .....	38
4.3 Selecting the Spectral Unit for all Installed Modules.....	39
4.4 Configuring the OSICS Mainframe Modulation.....	40
4.4.1 Setting Up Digital (TTL) Modulation Using the Mainframe Internal Source.....	41
4.4.2 Setting Up Digital (TTL) Modulation Using an External Source .....	43
4.4.3 Using the Mainframe as a Modulation Source for External Devices (Synchro Output) ...	44
<b>5. Setting a Working Configuration.....</b>	<b>45</b>
5.1 Saving a Working Configuration .....	47

5.2	Loading a Working Configuration .....	48
<b>6.</b>	<b>Using the OSICS ATN Module.....</b>	<b>49</b>
6.1	OSICS ATN Presentation .....	49
6.1.1	OSICS ATN Technical Specifications .....	49
6.1.2	OSICS ATN Module Overview.....	50
6.2	Setting the OSICS ATN Optical Attenuation .....	52
6.2.1	Setting the Attenuation to a Definite Value .....	52
6.2.2	Performing Real-time Adjustments to the ATN Attenuation.....	53
6.2.3	Step-Adjusting the ATN Attenuation.....	54
6.3	Setting the ATN Wavelength .....	55
6.4	Setting the ATN Attenuation Offset.....	56
<b>7.</b>	<b>Using the OSICS BKR Module .....</b>	<b>57</b>
7.1	OSICS BKR Presentation .....	57
7.1.1	OSICS BKR Technical Specifications.....	57
7.1.2	OSICS BKR Module Overview .....	58
7.2	Setting the OSICS BKR Optical Reflectance .....	59
7.2.1	Setting the Reflectance to a Definite Value.....	59
7.2.2	Performing Real-time Adjustments to the BKR Reflectance.....	60
7.2.3	Step-Adjusting the BKR Attenuation .....	61
7.3	Setting the BKR Wavelength/Frequency .....	62
7.4	Setting the BKR Attenuation Offset .....	63
<b>8.</b>	<b>Using the OSICS DFB Module .....</b>	<b>65</b>
8.1	OSICS DFB Presentation.....	65
8.1.1	OSICS DFB Technical Specifications.....	65
8.1.2	OSICS DFB Module Overview .....	67
8.2	Enabling/Disabling the Light Source of the Module .....	69
8.3	Setting the Optical Output Power of the DFB Module .....	70
8.3.1	Specifying the Optical Output Power of the Module .....	70
8.3.2	Performing Real-time Adjustments to the Output Power.....	71
8.4	Setting the Optical Emission Wavelength/Frequency .....	72
8.4.1	Specifying the Optical Emission Wavelength/Frequency.....	72
8.4.2	Step-adjusting the Wavelength/Frequency Value of the Module .....	73
8.5	Configuring the OSICS DFB Signal Modulation.....	74
8.5.1	Setting Up Digital (TTL) Modulation Using the DFB Module Internal Source .....	75
8.5.2	Setting Up Digital (TTL) Modulation Using the Mainframe Internal Source.....	77
8.5.3	Setting Up Digital (TTL) Modulation Using an External Source .....	80
8.5.4	Setting Up Analog Modulation Using an External Source .....	83
8.5.5	Setting Up Analog Modulation With the Internal Sinus Modulation .....	86
8.5.6	Using the DFB Module as a Modulation Source for External Devices (OUT 2 Output) .....	90
8.6	Monitoring the OSICS DFB Module Parameters Using the Analog OUT 1 Output.....	91
8.7	Calibrating the DFB Module.....	92
8.7.1	Performing a Wavelength Calibration.....	92
8.7.2	Performing a Power Calibration.....	93

8.7.3	Asking for a Factory Recalibration.....	94
8.8	Testing the Performance of the DFB Module .....	95
8.8.1	Preparing Performance Tests .....	95
8.8.2	Measuring the Absolute Wavelength Accuracy .....	96
8.8.3	Verifying the Wavelength Stability .....	96
8.8.4	Verifying the Power Stability .....	97
<b>9.</b>	<b>Using the OSICS SLD Module .....</b>	<b>99</b>
9.1	OSICS SLD Presentation.....	99
9.1.1	OSICS SLD Technical Specifications .....	99
9.1.2	OSICS SLD Module Overview .....	100
9.2	Enabling/Disabling the Light Source of the Module .....	102
9.3	Setting the Optical Output Power of the SLD Module .....	103
<b>10.</b>	<b>Using the OSICS SWT Module .....</b>	<b>105</b>
10.1	OSICS SWT Presentation.....	105
10.1.1	OSICS SWT Technical Specifications.....	107
10.1.2	OSICS SWT Module Overview .....	108
10.2	Selecting the OSICS SWT Input/Output.....	110
10.3	Configuring Sequential Switching.....	111
10.3.1	Selecting the Number of Scans .....	111
10.3.2	Setting the Timeframe.....	112
10.3.3	Launching/Stopping a Sequence.....	113
10.4	Testing the Performance of the SWT Module.....	114
10.4.1	Preparing Performance Tests.....	114
10.4.2	Verifying the Repeatability.....	115
10.4.3	Verifying the Crosstalk .....	116
<b>11.</b>	<b>Using the OSICS SWT APC Module.....</b>	<b>117</b>
11.1	OSICS SWT APC Presentation .....	117
11.1.1	OSICS SWT APC Technical Specifications.....	120
11.1.2	OSICS SWT APC Module Overview .....	121
11.2	Selecting the Operating Mode.....	122
11.3	Selecting the OSICS SWT APC Input/Output Channel (Switch Mode) .....	123
11.4	Configuring the Full-Band Mode .....	124
11.4.1	Automatically Detecting the T100 Modules Connected to the SWT APC.....	124
11.4.2	Manually Configuring the T100 Modules Connected to the SWT APC .....	125
11.5	Enabling/Disabling the Light Source of all Connected Modules (Full-Band Mode) .....	127
11.6	Setting the Optical Output Power of the SWT APC Module (Full-Band Mode) .....	128
11.7	Setting the Optical Emission Wavelength/Frequency (Full-Band Mode) .....	129
11.7.1	Specifying the Optical Emission Wavelength/Frequency.....	129
11.7.2	Step-adjusting the Wavelength/Frequency Value of the Module .....	130
11.7.3	Scanning a Predefined Wavelength/Frequency Range .....	131
11.8	Activating Coherence Control on all Connected T100 Modules (Full-Band Mode).....	133
11.9	Activating the Auto-peak Find Function (Full-Band Mode) .....	134
11.10	Configuring the Modulation for All Connected T100 Modules (Full-Band Mode) .....	135

11.10.1	Defining the Modulation Source for All Connected T100 Modules .....	135
11.10.2	Controlling the Modulation of All Connected T100 Modules.....	136
11.11	Monitoring the Optical Output Power of the SWT APC Module.....	137
11.12	Testing the Performance of the SWT APC Module .....	138
11.12.1	Preparing Performance Tests .....	138
11.12.2	Verifying the Repeatability.....	139
11.12.3	Verifying the Crosstalk .....	140
<b>12.</b>	<b>Using the OSICS T100 Module.....</b>	<b>141</b>
12.1	OSICS T100 Presentation.....	141
12.1.1	OSICS T100 Technical Specifications .....	141
12.1.2	OSICS T100 Module Overview .....	143
12.2	Enabling/Disabling the Light Source of the Module .....	145
12.3	Setting the Optical Output Power of the T100 Module.....	146
12.3.1	Specifying the Optical Output Power of the Module .....	146
12.3.2	Performing Real-time Adjustments to the Output Power.....	147
12.4	Setting the Optical Emission Wavelength/Frequency .....	148
12.4.1	Specifying the Optical Emission Wavelength/Frequency.....	148
12.4.2	Step-adjusting the Wavelength/Frequency Value of the Module .....	149
12.5	Activating Coherence Control .....	150
12.6	Activating the Auto-peak Find Function .....	151
12.7	Configuring the OSICS T100 Signal Modulation .....	152
12.7.1	Setting Up Digital (TTL) Modulation Using the T100 Module Internal Source.....	153
12.7.2	Setting Up Digital (TTL) Modulation Using the Mainframe Internal Source.....	155
12.7.3	Setting Up Digital (TTL) Modulation Using an External Source .....	158
12.7.4	Setting Up Analog Modulation Using an External Source .....	161
12.7.5	Using the T100 Module as a Modulation Source for External Devices (OUT 2 Output)..	164
12.8	Monitoring the OSICS T100 Module Parameters Using the Analog OUT 1 Output .....	165
12.9	Calibrating the T100 Module.....	166
12.9.1	Performing a Wavelength Reference Calibration.....	166
12.9.2	Performing a Wavelength/Frequency ( $\lambda/f$ ) Calibration .....	166
12.9.3	Performing a Power Calibration.....	168
12.9.4	Asking for a Factory Recalibration.....	169
12.10	Testing the Performance of the T100 Module.....	170
12.10.1	Preparing Performance Tests .....	170
12.10.2	Measuring the Absolute Wavelength Accuracy .....	171
12.10.3	Checking the Wavelength Range and Output Power .....	171
12.10.4	Validating the Side Mode Suppression .....	172
<b>13.</b>	<b>Performing Basic Maintenance Operations.....</b>	<b>173</b>
13.1	Cleaning the OSICS Multifunction Platform.....	173
13.2	Cleaning Optical Connectors.....	174
13.3	Replacing the Line Fuses.....	175
13.4	Packaging for Shipment .....	175
<b>14.</b>	<b>Troubleshooting.....</b>	<b>177</b>



14.1 OSICS Mainframe Error and Warning Messages ..... 177

14.2 OSICS Modules Error and Warning Messages..... 178

**Certification and Compliance ..... 179**

**List of Figures ..... 181**



# Important Safety Information for Your Product

Before you start working with your device, you need to first read the important safety information provided in this section. This section provides information that may supplement or add safety information to the user guides of your product. Keep this information close at hand.

You can obtain a copy of the complete user guide for your product at the following link: [www.EXFO.com](http://www.EXFO.com)













## Important

- If you see the  symbol on your unit, make sure that you refer to the instructions provided in this safety notice. Ensure that you understand and meet the required conditions before using your product.
- Other safety instructions relevant for your product are located throughout this documentation, depending on the action to perform. Make sure to read them carefully when they apply to your situation.

## Product Safety

### Safety Symbols on Your Product

One or more of the following symbols may appear on your product.

Symbol	Meaning
	Direct current
	Alternating current
	The product is equipped with an earth (ground) terminal.
	The product is equipped with a protective conductor terminal.
	The product is equipped with a frame or chassis terminal.
	On (Power)
	Off (Power)
 or 	On/Off (Power)
	Fuse

### Electrical Safety Information

This unit uses an international safety standard three-wire power cable. This cable serves as a ground when connected to an appropriate AC power outlet.



### Warning

- The use of voltages higher than those indicated on the label affixed to your unit may damage the unit.
- The use of controls, adjustments and procedures, namely for operation and maintenance, other than those specified herein may result in hazardous radiation exposure or impair the protection provided by this unit.
- If the equipment is used in a manner not specified by the manufacturer, the protection provided by the equipment may be impaired.
- Use only accessories designed for your unit and approved by EXFO. For a complete list of accessories available for your unit, see its technical specifications or contact EXFO.
- Use only the certified power cord that is suitably rated for the country where the unit is used. Replacing detachable mains supply cords by inadequately rated cords, may result in overheating of the cord and create a fire risk.
- Unless otherwise specified, all interfaces are intended for connection to Safety Extra Low Voltage (SELV) circuits only.
- To avoid electrical shock, do not operate the unit if any part of the outer surface (covers, panels, etc.) is damaged.
- Operation of any electrical instrument around flammable gases or fumes constitutes a major safety hazard.
- Only authorized personnel should carry out adjustments, maintenance or repair of opened units under voltage. A person qualified in first aid must also be present. Do not replace any components while the power cable are connected.
- Use only fuses with the required rated current and specified type. Do not use repaired fuses or short-circuited fuse holders. For more information, see the section about replacing the fuses in this user documentation.



### Caution

- Where applicable, the operation and storage temperatures, as well as the altitude and relative humidity values of some modules may differ from those specified for your platform. In this case, always ensure that you comply with the most restrictive conditions (either module or platform).
- Position the unit so that the air can circulate freely around it.

Optical Safety

Safety Symbols on Your Product

Symbol	Meaning
	This symbol on your product indicates that the unit is equipped with a laser source, or that it can be used with instrument equipped with a laser source. These instruments include but are not limited to, modules and external optical units.

Optical Safety Instructions

Your instrument is in compliance with standards IEC 60825-1: 2007 and 2014.



**Warning**

- (IEC 60825-1: 2007) Viewing the laser output with certain optical instruments designed for use at a distance (for example, telescopes and binoculars) may pose an eye hazard.
- (IEC 60825-1: 2014) Viewing the laser output with telescopic optical instruments (for example, telescopes and binoculars) may pose an eye hazard and thus the user should not direct the beam into an area where such instruments are likely to be used.
- Do not install or terminate fibers while a light source is active.
- Never look directly into a live fiber and ensure that your eyes are protected at all times.

Laser radiation may be encountered at the optical output port.

The following labels indicate that the product contains a Class 1M source:

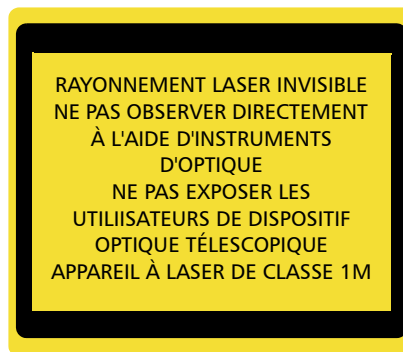
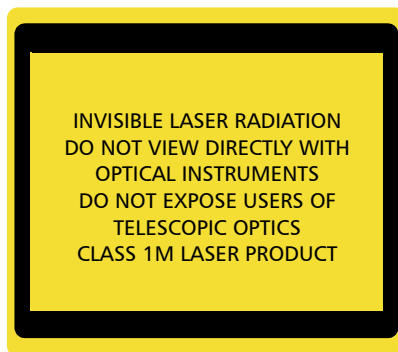

Wavelength: / Longueur d'onde : 1519-1635 nm

Pout max: / Psortie max. : ≤ 25 mW/42 mW (on 1240-1400 nm); 100 mW (on 1400-1680 nm)

Complies with standards 21 CFR 1040.10, except for deviations pursuant to Laser Notice No. 50, dated June 24, 2007.



# 1. Product Presentation

## 1.1 Product Features

The OSICS multifunction platform is an 8-channel modular instrument designed for fiber-optic component and system testing, particularly for DWDM system evaluations.

It is composed of the following elements:

- **The OSICS Mainframe**

The OSICS Mainframe contains eight multipurpose slots that can host up to eight pluggable modules such as tunable lasers, transmission lasers and passive optical functions and sources.

The OSICS Mainframe provides built-in front panel controls and display to drive both system common controls and module parameters. All system operations are software-controlled from the OSICS Mainframe front panel.

Any OSICS module can be inserted in any multipurpose module-slot and in any combination. The OSICS Mainframe automatically detects OSICS modules after plug-in.

The OSICS Mainframe is designed either for benchtop use (with or without the front legs deployed) or rack-mount using two rack handles (optional).

You can remotely operate the OSICS system via the available communication interfaces.

The OSICS Mainframe can automatically save the working configuration of all eight modules simultaneously. This allows restoring the operating parameters of the OSICS Mainframe and modules instantly as you left them at the last system turn-off.

- **The OSICS pluggable modules**

All OSICS modules are of the same physical dimension and size. OSICS modules are plug-and-play units that require no additional hardware or software.

## 1.2 OSICS Mainframe Technical Specifications

The following table gives an overview of technical specifications of the OSICS Mainframe. Detailed specifications of all OSICS modules are detailed in *OSICS User Guide*.

<b>General Characteristics</b>	
Number of slots	8
Supported pluggable modules	All OSICS modules in any combination
<b>Electrical Specifications</b>	
Fuse types	2x T4AL250V Equipment has double fuse in both Line and Neutral conductors.
Power Supply	100-240 V AC
Power Supply Frequency	50-60 Hz
Maximum Input Current	5 A rms
Maximum Power Consumption	300 W
<b>Interfaces</b>	
Control Panel	Screen, rotary knob, on/off and control buttons
Remote Control	<ul style="list-style-type: none"> <li>• GPIB connector for IEEE 488 communication</li> <li>• USB-B connector for RS-232C communication</li> <li>• SubD-9 for remote interlock</li> </ul>
Analog Monitoring	Multi-purpose BNC output for current, power or temperature monitoring of each pluggable module
Modulation	<ul style="list-style-type: none"> <li>• Input: <ul style="list-style-type: none"> <li>• External TTL modulation (Mod. In BNC connector)</li> <li>• Internal TTL modulation (on-board oscillator)</li> </ul> </li> <li>• Output: Synchro BNC connector</li> </ul>
<b>Environmental Specifications</b>	
Equipment Type	Test and measurement
Equipment Location	Indoor use only
Operating Temperature Range	+15 °C to 35 °C (+59 °F to +95 °F) ambient temperature
Warm up Time (at room temperature)	1 hour (typ.)
Humidity	80 % to 50 % relative humidity (with maximum operating temperature ranging from 31 °C to 40 °C)
Maximum Operating Altitude	2000 meters
<b>Physical Specifications</b>	
Dimensions (W x H x D)	448 x 145 x 387 mm
Weight	7.2 kg



## 1.3 Product Overview

- The OSICS Mainframe is delivered with the following accessories:
  - A power supply cable
  - A USB key containing the OSICS documentation and available software
- OSICS modules are delivered with a certificate of calibration.

### 1.3.1 OSICS Front Panel

The front panel of the OSICS Mainframe is composed of:

- The control panel, with display and control buttons
- The modules area, with eight slots for pluggable OSICS modules.

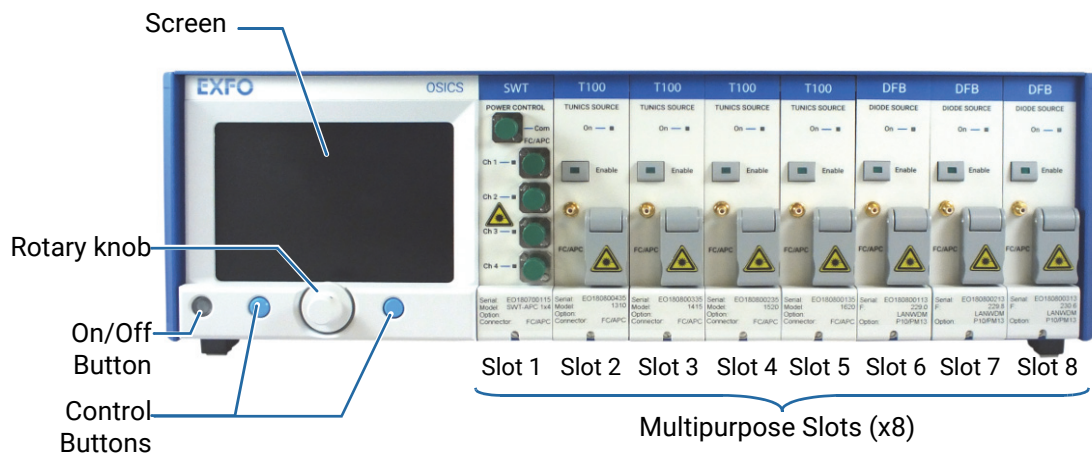

Figure 1: Mainframe – Front Panel

#### Control Panel

- **Screen**  
The screen displays the operating parameters and readings (updated in real-time) of all plugged modules.
- **On/Off Button**  
The On/Off button turns on/off the OSICS Mainframe.  
The button lights green if the OSICS Mainframe is turned on.
- **Rotary knob**  
The rotary knob enables you to navigate through the menus and to modify the value of selected parameters:
  - Turning the knob enables you to navigate within menus or to modify the selected parameter values.
  - Pressing the knob enables you to select a menu or to validate a selection or a value.
- **Left/Right Control Buttons**  
The control buttons allow you to command the functions displayed on screen right above them.

#### Modules area

Any OSICS module can be placed in any of the eight multipurpose slots. For more details, see section *Handling OSICS Modules Into the OSICS Mainframe*, p. 23.

## 1.3.2 OSICS Rear Panel

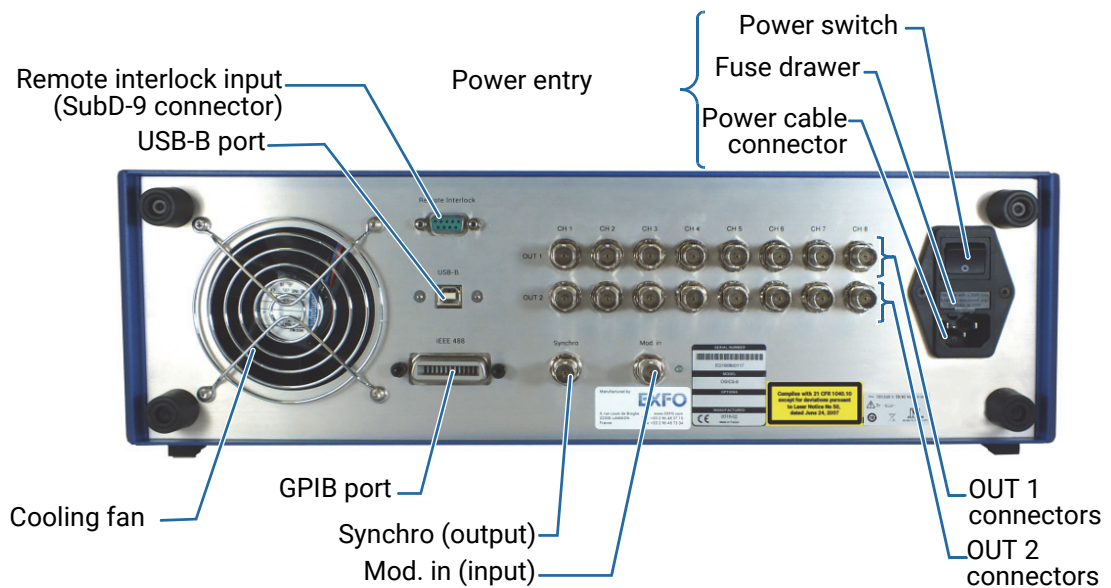

Figure 2: Mainframe – Rear Panel

### Power entry

The power entry part includes the following elements:

- **Power switch**
- **Power cable connector**  
The OSICS Mainframe unit is equipped with a self-regulating power supply (for details, see section *OSICS Mainframe Technical Specifications*, p. 16).
- **Fuse drawer**  
The fuse holder contains two fuses to protect the OSICS Mainframe from overcurrent (for fuse types, see section *OSICS Mainframe Technical Specifications*, p. 16). For details on how to replace the fuses, see section *Replacing the Line Fuses*, p. 175.

### Remote Interfaces

- **USB-B (RS-232C)**  
This port enables you to perform RS-232C remote control operations. For more information, see *OSICS Programming Guide*.
- **IEEE 488 (GPIB)**  
This port enables you to perform IEEE 488.2 remote control operations. For more information, see *OSICS Programming Guide*.

### Inputs

- **Mod. In**  
You can use this BNC connector as input for external TTL-modulated signals. The green LED located to the right side of the connector is lit when the **Mod. In** connector receives an external TTL-modulated signal.

The OSICS Mainframe can provide an internal TTL-modulated signal to the OSICS T100 and OSICS DFB modules:

- OSICS T100: see section *Configuring the OSICS T100 Signal Modulation*, p. 152.
- OSICS DFB: see section *Configuring the OSICS DFB Signal Modulation*, p. 74.
- **Remote Interlock** (SubD-9 connector)  
On/off switch for laser safety (see section *Installing the Remote Interlock*, p. 27).

### Outputs







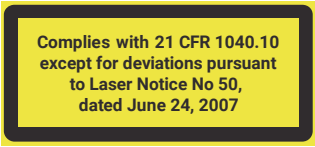

- **Synchro**  
This BNC connector provides a modulated-signal enabling the OSICS Mainframe to synchronize measurements on external devices or instruments (see section *Using the Mainframe as a Modulation Source for External Devices (Synchro Output)*, p. 44).
- **OUT 1**
  - For T100 pluggable module, this BNC analog-output connector enables channel monitoring of power and current: see section *Monitoring the OSICS T100 Module Parameters Using the Analog OUT 1 Output*, p. 165.
  - For DFB modules, this BNC analog-output connector enables channel monitoring of power, current and temperature: see section *Monitoring the OSICS DFB Module Parameters Using the Analog OUT 1 Output*, p. 91.
  - For SWT-APC modules, this BNC analog-output connector enables channel monitoring of the power: see section *Monitoring the Optical Output Power of the SWT APC Module*, p. 137.
- **OUT 2**  
This BNC analog-output connector enables you to use the T100 or DFB modules as an external modulation source for external devices:
  - OSICS T100: see section *Using the T100 Module as a Modulation Source for External Devices (OUT 2 Output)*, p. 164.
  - OSICS DFB: see section *Using the DFB Module as a Modulation Source for External Devices (OUT 2 Output)*, p. 90.

### Cooling Fan

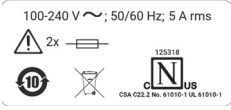
The cooling fan extracts warm air from inside. A cover grid protects it.

## 1.3.3 OSICS Information and Warning Markings

Label	Description
	<p><b>Identification of the Product</b></p> <p>Indicates serial number, model, options (if any), CE marking and date of manufacture.</p>

Label	Description
	<p><b>Manufacturer Identification</b> Contact information of the manufacturer.</p>
	<p><b>Class 1M Laser Product</b> The product may have a built-in light source (depending on the OSICS modules installed), which makes it a class 1M laser product, as defined by the standard on safety of laser products (see section <i>Certification and Compliance</i>, p. 179). This means that it is safe under all conditions of normal use except when viewed with optical instruments such as microscopes and telescopes. Class 1M lasers produce large-diameter beams, or beams that are divergent.</p>
	<p><b>Laser Radiation Label</b> Affixed on OSICS modules, this label indicates the location of the laser source. Do not look directly into the fiber end of an optical cable connected to any optical output while the device is in use. This may cause permanent eye damage.</p>
	<p><b>Power and Compliance</b></p> <ul style="list-style-type: none"> <li>•  indicates an injury hazard. It appears on a location that requires special instructions for proper use: see section <i>Connecting the OSICS Mainframe to a Power Source</i>, p. 22.</li> <li>•  : AC input rating.</li> <li>•  : the fuse types are described in section <i>OSICS Mainframe Technical Specifications</i>, p. 16.</li> <li>• Compliances: see section <i>Certification and Compliance</i>, p. 179.</li> </ul>
	<p><b>Caution while Handling Label</b> (OSICS T100 module only). This label is affixed on the module side panel, as pressing the sides could result in potential damage to the product.</p>
	<p><b>Warranty Seal</b> The product cover must not be open, otherwise the warranty is not valid anymore.</p>

## 2. Installing and Connecting the OSICS Multifunction Platform

### 2.1 Unpacking and Installing the OSICS Mainframe

**Subject** When used as a stand-alone bench-top instrument, the OSICS Mainframe is designed so that the feet leave enough room under the product to enable proper ventilation. The apertures (under the product) and the fan (behind the product) are used for the inside ventilation.

#### Before Starting



#### Caution

- To ensure proper environment conditions:
  - Make sure the location where the OSICS Mainframe will be installed meets the environmental characteristics listed in section *OSICS Mainframe Technical Specifications, p. 16*.
  - Do not install the OSICS Mainframe near any source of heat or cold.
- To ensure proper ventilation and cooling, make sure there is sufficient clearance below and at the back of the OSICS Mainframe in the place where it will be installed.
- If you plan to rack-mount the product (depends on version), make sure to allow at least a 15 mm (0.6 inches) gap between two products.

#### Procedure

1. Open the package with care and remove the protective foam.



#### Important

When unpacking, handle the device with care and do not damage the original shipping container in case the OSICS Mainframe needs to be returned to EXFO.

2. Pull out the OSICS Mainframe vertically from its packaging: hold it by its two retractable handles located on both sides of the product and keep it horizontal.
3. Set the OSICS Mainframe on a flat stable surface free of excessive vibration.
4. Allow the flow of air to circulate freely around the OSICS Mainframe and remove any equipment or object that could block the air flow. Ventilation holes are located on the bottom and back sides of the OSICS Mainframe.
5. On the rear panel (see *Figure 2, p. 18*), make sure the power switch is set to **O**.
6. To tilt the OSICS Mainframe upward, deploy the two retractable legs located below it.



Figure 3: Retractable Legs

## 2.2 Connecting the OSICS Mainframe to a Power Source

**Subject** The OSICS Mainframe is equipped with a self-regulating power supply. For voltage specifications, see section *OSICS Mainframe Technical Specifications, p. 16*.

### Before Starting



#### Warning

- Make sure the product power source does not apply more than 265 Volts RMS between the supply conductors or between either of the supply conductors and the ground.
- To avoid the possibility of injury, make sure the socket outlet in which the power supply cable will be plugged is equipped with a protective ground contact, and that the electrical installation fulfills the local safety requirements.
- The OSICS Mainframe has a chassis connected to ground via the power supply cable. A protective ground connection by way of the grounding conductor in the power cable is essential for safe operation.
- The OSICS Mainframe is not designed for outdoor use. To avoid the possibility of injury, do not expose the product to rain or excessive moisture. Do not operate the product in the presence of flammable gases or fumes.

### Procedure

1. Make sure the power switch is set to **O**.
2. Connect one end of the provided power supply cable to the mains socket located on the rear panel and plug the other end to the proper voltage wall socket outlet (to know the voltage requirement, see section *OSICS Mainframe Technical Specifications, p. 16*).

## 2.3 Handling OSICS Modules Into the OSICS Mainframe

OSICS modules can be installed in the OSICS Mainframe in any of the available 8 channel-slots and in any combination alongside other types of modules supported by the OSICS platform.

### 2.3.1 Installing an OSICS Module Into the OSICS Mainframe

#### Subject

This section explains how to install an OSICS module into a empty slot of the OSICS Mainframe. All OSICS modules can be installed in any of the available 8-channel slots of the OSICS Mainframe and in any combination alongside other types of OSICS modules.

#### Before Starting

- Open the package with care and remove the OSICS module from its packaging.



#### Important

When unpacking, handle the device with care and do not damage the original shipping container in case the OSICS module needs to be returned to EXFO.

- Make sure you have a medium-small size flat blade screwdriver.

#### Procedure

1. Turn the OSICS Mainframe off (see section *Turning Off the OSICS Multifunction Platform*, p. 36) and unplug the power supply cable.



#### Caution

Do not perform any hardware installation or maintenance operation while the system is in operation.

2. Unpack the OSICS module from its wrapping.

- On the OSICS Mainframe front panel, remove the cover plate of the slot where you want to install the module: loosen the captive screw using a medium-small flat blade screwdriver and remove the plate.

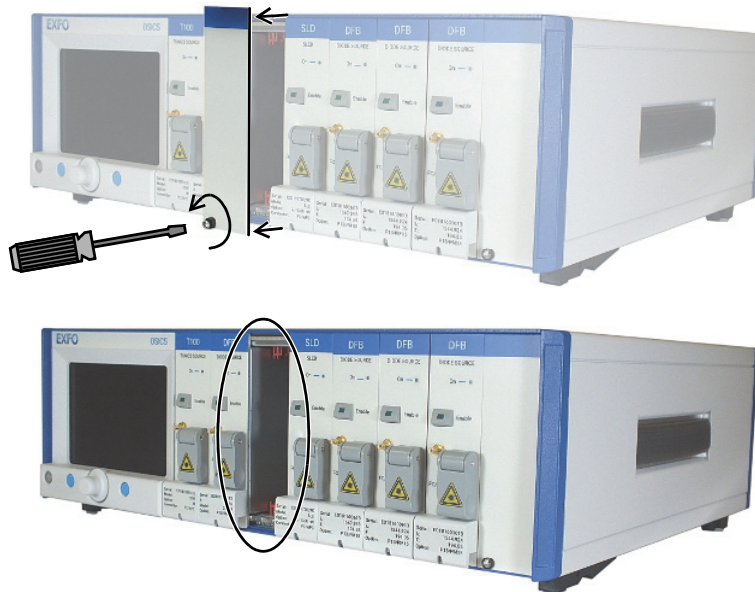

Figure 4: Module Installation – Plate Removal

- Hold the module with both hands by its top and bottom edges in front of the open slot to align the top and bottom edges of the module with the slot guides on the OSICS chassis and insert the module into the open slot.



**Caution**

To avoid damaging the internal optical components, do not squeeze the module sideplates.

- Put your thumb on the captive screw notch of the module to push it in so that it slides in freely.
- Apply pressure to seat the module in the OSICS Mainframe backplane connector.
- Tighten the captive screw of the module to secure it in place:



Figure 5: Module Installation – Module Insertion



## 2.3.2 Removing an OSICS Module From the OSICS Mainframe

**Subject** This section explains how to remove an OSICS module from the OSICS Mainframe.

**Before Starting** Make sure you have a medium-small size flat blade screwdriver.

**Procedure**

1. Turn the OSICS Mainframe off (see section Turning Off the OSICS Multifunction Platform, p. 36) and unplug the power supply cable.



### Caution

Do not perform any hardware installation or maintenance operation while the system is in operation.

2. On the OSICS Mainframe front panel, loosen the captive screw of the module you want to remove using a medium-small flat blade screwdriver.
3. Put your index and middle finger inside the groove located behind the captive screw notch of the module, and pull the module out as illustrated in the following figure:



Figure 6: Module Installation – Module Removal



### Caution

Do not extract the module by pulling on any of the front-panel protruding elements, such as the laser protection cap or connectors because this may loosen or damage those elements permanently.

4. Hold the module with both hands by its top and bottom edges and put it in its original container.
5. On the OSICS Mainframe front panel, put a cover plate on the empty slot and tighten the captive screw to secure it in place.



### Caution

Do not operate the OSICS Mainframe if a channel-slot is left open. Always put back the protection cover plate on an empty slot.

## 2.4 Connecting Optical Devices to OSICS Modules

**Subject** You can connect external optical components and instruments to the OSICS modules.



**Caution**

- Keeping fiber-optic connectors clean at all times is essential to achieve optimum system performance (see section *Cleaning Optical Connectors*, p. 174).
- The standard output connector is a FC/APC connector. Never connect another type of connector to the optical output.

**Before Starting**

Make sure you have the appropriate fiber type corresponding to the modules you want to connect. For details on the appropriate optical fiber type, see the *Technical Specifications* section corresponding to the modules you want to connect in the appropriate module section of this user guide)



**Warning**

The use of optical instruments with this product increases eye hazard. Do not look directly into the fiber end of an optical cable connected to any optical output while the device is in use. This may cause permanent eye damage.

**Procedure**

1. Disable the laser output before connecting or disconnecting a fiber optic cable on the module (see section *Enabling/Disabling the Light Source of All Modules*, p. 37).
2. Make sure fiber-optic connectors are clean.
3. On the front panel, lift the protective cap and connect the optical component(s) to the OSICS module via the FC/APC fiber-optic connector.
4. In case of frequent connect/disconnect, use an intermediate jumper to prevent premature failure of the OSICS module internal connector.



**Caution**

On OSICS SWT, do not connect several laser sources at the same time on the Com and Chn channels, or you may severely damage your optical equipment.

## 2.5 Installing the Remote Interlock

**Subject** The OSICS Mainframe is equipped with a Remote Interlock connector at the rear panel. You can connect an external remote interlock switch to the Remote Interlock SubD-9 connector located on the rear panel.

Remote interlock sets the system current and power to 0 mA and 0 mW, respectively.

**Before Starting** Make sure that the external switch is electrically isolated from other circuits, including earth ground.

- Procedure**
- To connect the remote interlock switch, use a connector that meets the following pin assignment:
    - Pins 1-2: shorted
    - Pins 6-7: connect to external switch

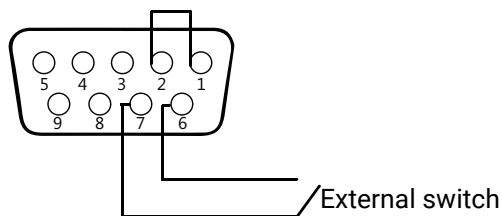

Figure 7: Remote Interlock pin assignment

- If the remote interlock switch is open, the laser output of all modules installed on the OSICS Mainframe is switched off.

In the **System Status** screen (see *System Status Screen Description* section, p 30), the message **INTERLOCK** is displayed for all installed modules to indicate that the OSICS laser output is switched off.

- If the remote interlock switch is closed, the OSICS system laser output is switched back on.



# 3. Turning On/Off and Initializing the OSICS Multifunction Platform

## 3.1 Turning on the OSICS Multifunction Platform and Accessing the System Status Screen

**Subject** Turning on the OSICS multifunction platform also turns on all installed modules. After the OSICS multifunction platform is turned on, the **System Status** screen is automatically displayed.

**Before Starting** Make sure the OSICS Mainframe is properly installed and connected (see section *Installing and Connecting the OSICS Multifunction Platform*, p. 21).

- Procedure**
1. On the rear panel, set the **MAINS** power switch to **I** (see *Figure 2*, p. 18).
  2. On the front panel, press the on/off button (see *Figure 1*, p. 17).



**Caution**

Do not turn the OSICS Mainframe off before the system is fully initialized.

- The OSICS Mainframe performs the initialization routine, the message *Initializing* appears.
- The OSICS Mainframe prompts you to enter a password.

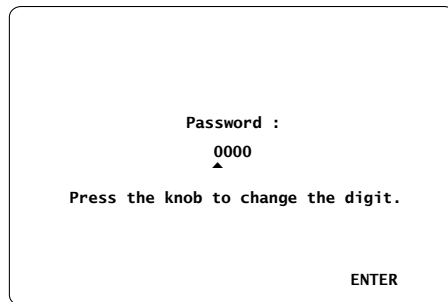

*Figure 8: Password Screen*

3. Enter your password as follows (default password is 0000):
  - a. Turn the rotary knob to put the cursor under the digit you want to modify and press the knob to highlight it.
  - b. Turn the knob clockwise to increase the value or anticlockwise to decrease it and press the knob to validate the selected digit.
  - c. Perform steps a. and b. again with the other digits to modify.

To modify the password, see section *Modifying the OSICS Mainframe Password*, p. 35.

If you forget your password, contact the EXFO customer support service (see section *Contact Information*, p. 4).

4. Select **ENTER** by pressing the right control button.

After password identification, each module is initialized, turned on (the green LED is lit) and set to the power-up wavelength.

At the end of the initialization routine, the STARTUP configuration is loaded on the OSICS Mainframe and on each installed module (for more details on working configurations, see section *Setting a Working Configuration*, p. 45).

The **System Status** screen appears.

**System Status Screen Description**

The System Status screen provides a general overview of the state, configuration and operating parameters of the system.

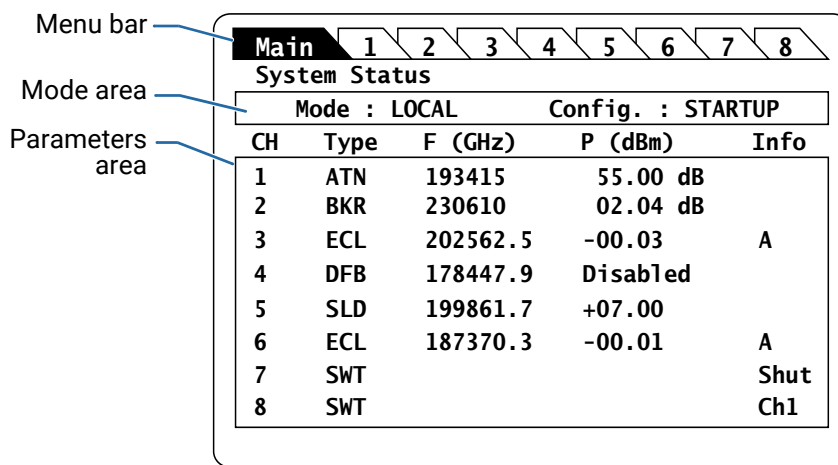

Figure 9: System Status Screen

**Menu bar**

The menu bar is displayed at the upper part of all screens.

It includes the following tabs:

- The **Main** menu tab enables you configure the OSICS Mainframe (see section *Accessing the OSICS Mainframe Main Setup Menu*, p. 33)
- One tab for each OSICS module, from left to right (1 to 8), to configure each module individually (see section *Accessing an OSICS Module Setup Menu*, p. 33).

To select a tab, turn the rotary knob to highlight the wanted tab and press the knob to enter the tab menu.

**Mode area**

The mode area displays the following read-only information:

- Current system operating-mode (for more details, see *OSICS Programming Guide*).
- Working configuration currently active (for more details, see section *Setting a Working Configuration*, p. 45).

### Parameters area

The **Parameters** area is a read-only table that displays the key operating-parameters of the installed modules, as described in the following table.

Column Name	Description of Value Displayed
<b>CH</b>	Slot number, corresponding to the modules installed in the OSICS Mainframe.
<b>Type</b>	Type of module installed in the corresponding slot. If the slot is empty, the field is left blank.
<b><math>\lambda</math> (nm)/ f (GHz)</b>	Light emission wavelength or frequency of the module, depending on the selected wavelength unit (see section <i>Selecting the Spectral Unit for all Installed Modules</i> , p. 39).
<b>P (dBm)/ P (mW)</b>	Output power information: <ul style="list-style-type: none"> <li>• <b>&lt;value&gt;</b>: output power value of the module in dBm or mW depending on the selected power unit (see section <i>Selecting the Power Unit for All Installed Modules</i>, p. 38).</li> <li>• <b>Disabled</b>: the laser output of the corresponding module is disabled. If no specific configuration has been defined (see section <i>Setting a Working Configuration</i>, p. 45), each OSICS module is in the disable (idle) state after system initialization.</li> <li>• <b>INTERLOCK</b>: the laser safety Interlock switch is open. In this case, all modules are disabled (for more details, see section <i>Installing the Remote Interlock</i>, p. 27).</li> </ul>
<b>Info</b>	Additional information on module operating status, as explained in the following lines.
<b>A</b>	T100 modules only. The <b>Auto peak find</b> function is enabled (see sub-section <i>Activating the Auto-peak Find Function</i> in the appropriate module section of this user guide).
<b>BO2S BS2O BS2S BO2O</b>	SWT 2x(1x1) modules only. Selected output mode (see section <i>Selecting the OSICS SWT Input/Output</i> , p. 110): <ul style="list-style-type: none"> <li>• <b>BS2S</b>: both shut.</li> <li>• <b>BO2O</b>: both open.</li> <li>• <b>BO2S</b>: Ch A-B open, Ch 1-2 shut.</li> <li>• <b>BS2O</b>: Ch A-B shut, Ch 1-2 open.</li> </ul>
<b>Bar/ Cross</b>	SWT 2x2 module only. Selected output mode (see section <i>Selecting the OSICS SWT Input/Output</i> , p. 110).
<b>C</b>	T100 modules only. The <b>Coherence control</b> function is enabled (see section <i>Activating Coherence Control</i> in the appropriate module section of this user guide).
<b>CHn</b>	SWT modules only. Selected channel number (see section <i>Selecting the OSICS SWT Input/Output</i> , p. 110).
<b>LIM</b>	The selected power value cannot be set due to a maximum current-limit reached within the laser diode.
<b>M</b>	T100 and DFB modules only. The modulation option is set to ON or ON INVERTED (see sub-section <i>Configuring the Signal Modulation</i> in the appropriate module section of this user guide).

<b>Column Name</b>	<b>Description of Value Displayed</b>
<b>o</b>	ATN modules only. An offset is set (see section <i>Setting the ATN Attenuation Offset</i> , p. 56).
<b>s</b>	SWT module only. A sequence is running (see section <i>Configuring Sequential Switching</i> , p. 111).
<b>Shut</b>	SWT 1x1 modules only. Selected output mode (see section <i>Selecting the OSICS SWT Input/Output</i> , p. 110).



## 3.2 Accessing the OSICS Setup Menus

### Subject

Each element of the OSICS platform can be configured individually:

- The OSICS Mainframe setup menu (**Main Setup** menu) enables you to configure all the operating parameters of the OSICS Mainframe and some system parameters that affect all installed modules.
- The OSICS module setup menu (**<Module Name> Setup** menu) enables you to set the operating parameters of a selected OSICS module.

### Procedures

#### Accessing the OSICS Mainframe Main Setup Menu

1. From the **System Status** screen, turn the rotary knob to highlight the **Main** tab.
2. Press the knob to enter the highlighted menu.

The **Main Setup** menu appears.

#### Accessing an OSICS Module Setup Menu

1. From the **System Status** screen, turn the rotary knob to highlight the tab corresponding to the slot number in which the wanted module is installed (see *Figure 1, p. 17*).
2. Press the knob to enter the highlighted menu.

The **<Module Name> Setup** menu appears.

### Setup Menu Description

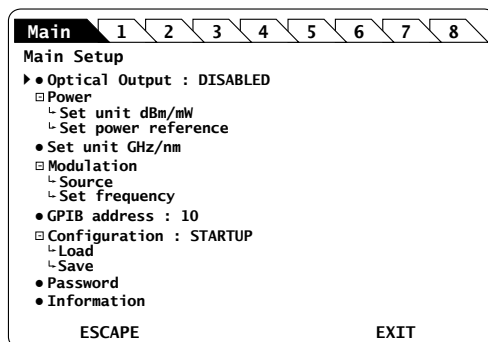

OSICS Mainframe Setup Menu

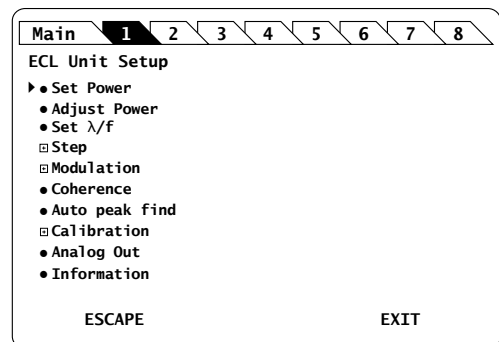

OSICS T100 Unit Setup Menu

Figure 10: Setup Menu – Examples

### Menus/Sub-menus and Symbols

- **▶** : indicates the location of the cursor operated using the rotary knob. To move the cursor, turn the rotary knob.
- **●** : indicates a menu without sub-menus. To enter this type of menu: turn the rotary knob to put the cursor before the menu and press the rotary knob.
- **+** : indicates a menu with one or more sub-menus.
  - **-** : indicates that the menu is expanded.
    - To expand a menu: turn the rotary knob to put the cursor before the menu and press the rotary knob.
    - To enter a sub-menu: turn the rotary knob to put the cursor before the sub-menu and press the rotary knob to enter into it.

**ESCAPE**

Returns to the previous displayed menu.

Press the left control button (see *Figure 1, p. 17*) to operate this command.

**EXIT**

Exits the current menu and displays the **System Status** screen.

Press the right control button (see *Figure 1, p. 17*) to operate this command.

You can only browse tabs from the **System Status** screen.

## 3.3 Checking the OSICS Version

**Subject**

The **Information** menu displays information about the version of your OSICS Mainframe or OSICS modules.

**Procedure**

**Checking the Firmware Version of the OSICS Mainframe**

1. Access the **Main Setup** menu (see section *Accessing the OSICS Setup Menus, p. 33*).
2. Turn the rotary knob to put the cursor before the **Information** menu and press the knob to enter it.

The information screen appears with the OSICS Mainframe FPGA and firmware revision number.

**Checking the Version Information of an OSICS Module**

1. Access the **<Module Name> Setup** menu (see section *Accessing an OSICS Module Setup Menu, p. 33*).
2. Turn the rotary knob to put the cursor before the **Information** menu and press the knob to enter it.

The information screen appears with the OSICS module information.

## 3.4 Modifying the OSICS Mainframe Password

**Subject** For laser safety reasons, a four digit password controls the access to the OSICS Mainframe.

The default password is 0000. This section explains how to modify it.

**Procedure**

1. Access the **Main Setup** menu (see section *Accessing the OSICS Setup Menus*, p. 33).
2. Turn the rotary knob to put the cursor before the **Password** menu and press the knob to enter it.

The **Password** sub-menu appears and prompts you to enter the actual password.

3. Enter the current password as follows:
  - a. Turn the rotary knob to put the cursor under the digit to modify and press the knob to highlight it.
  - b. Turn the knob clockwise to increase the value or anticlockwise to decrease it and press the knob to validate the selected digit.
  - c. Perform steps a. and b. again with the other digits to modify.
  - d. Turn the rotary knob clockwise to put the cursor under **ENTER** and press the knob to validate.

The screen prompts you to enter a new password.

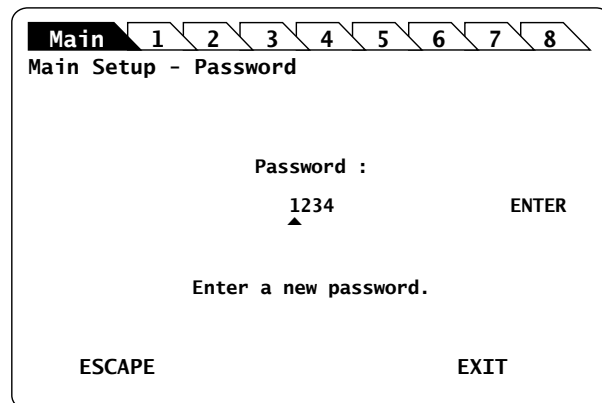

Figure 11: Main Setup – New Password

4. Enter the new password as follows:
  - a. Turn the rotary knob to put the cursor under the digit to modify and press the knob to highlight it.
  - b. Turn the knob clockwise to increase the value or anticlockwise to decrease it and press the knob to validate the selected digit.
  - c. Repeat steps a. and b. again with the other digits to modify.
  - d. Turn the rotary knob clockwise to put the cursor under **ENTER** and press the knob to validate.

A confirmation message appears.

5. Press the knob to confirm the password change.

## 3.5 Turning Off the OSICS Multifunction Platform

**Before Starting**      Disable the light source of all modules (see section *Enabling/Disabling the Light Source of All Modules*, p. 37)

- Procedure**
1. On the front panel, press the on/off button (see *Figure 1*, p. 17).  
The message `Saving Configuration` appears on screen. It indicates that the current system configuration is being saved in the STARTUP memory (the STARTUP configuration will be loaded at the next system start)
  2. Wait until the green LED of the on/off button lights off.
  3. On the rear panel, set the power switch to **O**.
  4. If you want to turn on the OSICS Mainframe again, wait at least 30 seconds.

## 4. Controlling the Optical Output of all OSICS Modules Simultaneously

From the OSICS Mainframe **Main Setup** menu, you can control optical output parameters of all installed modules simultaneously.

### 4.1 Enabling/Disabling the Light Source of All Modules

#### Subject

This procedure only applies to modules with an optical source.

You can enable/disable the optical output in two different ways:

- From the wanted module front panel, you can individually enable or disable the light source of the module by using the **Enable** button. For more details on this procedure, see sub-section *Enabling/Disabling the Light Source of the Module* in the appropriate module section of this guide.
- From the OSICS Mainframe **Main Setup** menu, you can simultaneously enable or disable the light source in all the modules installed in the OSICS Mainframe, as detailed in the following procedure. This function overrides the enable/disable state individually set in all modules.

#### Before Starting

Connect an optical device to the OSICS modules (see section *Connecting Optical Devices to OSICS Modules*, p. 26).



#### Warning

- Do not enable the laser while there is no fiber connected to the optical output connector.
- Do not look directly into the fiber end of an optical cable connected to any optical output while the device is in use. This may cause permanent eye damage.

#### Procedure

##### Enabling the Light Source of All Installed Modules

1. Access the **Main Setup** menu (see section *Accessing the OSICS Mainframe Main Setup Menu*, p. 33).
2. Turn the rotary knob to put the cursor before the **Optical Output : DISABLED** menu.
3. Press the rotary knob to enable the optical output of all installed modules.

The OSICS Mainframe beeps and the light source is enabled on all modules simultaneously (the green **Enable** LED of all modules lights on).

The menu displays **Optical Output : ENABLED**.

##### Disabling the Light Source of All Installed Modules

1. Access the **Main Setup** menu (see section *Accessing the OSICS Mainframe Main Setup Menu*, p. 33).
2. Turn the rotary knob to put the cursor before the **Optical Output : ENABLED** menu.
3. Press the rotary knob to disable the light source of all installed modules.  
The optical output is disabled on all modules simultaneously (the green **Enable** LED of all modules lights off).

## 4.2 Configuring the Optical Output Power of All Modules

### 4.2.1 Selecting the Power Unit for All Installed Modules

**Subject** The following procedure explains how to modify the power unit (dBm or mW) for all modules installed in the OSICS Mainframe. You cannot set the power unit of an individual module.

**Procedure** 1. Access the **Main Setup** menu (see section *Accessing the OSICS Mainframe Main Setup Menu*, p. 33).

2. Expand the **Power** menu and enter the **Set unit dBm/mW** sub-menu.

The **Set unit dBm/mW** sub-menu appears and displays the current unit setting.

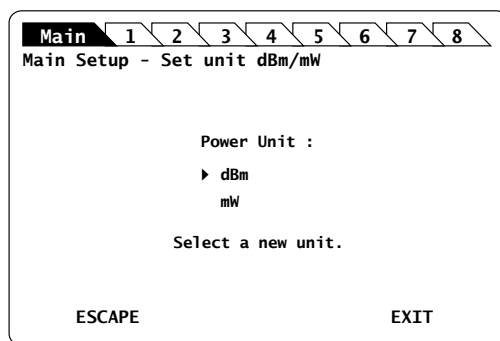

Figure 12: Main Setup – Set unit dBm/mW sub-menu

3. Turn the rotary knob to put the cursor before the wanted unit and press it to validate your selection.

The **Main Setup** menu is automatically displayed and the optical power value of each module is now set to the selected unit.

### 4.2.2 Setting the Optical Output Power of All Installed Modules

**Subject** You can set the optical output power in two different ways:

- From the wanted module menu, you can set the module output power individually. For more details on this procedure, see section *Setting the Optical Output Power of the Module* in the appropriate module section of this guide.
- From the OSICS Mainframe **Main Setup** menu, you can set all modules output power to the same value simultaneously, as detailed in the following procedure.

As modules of different types and different power specifications may be installed in the system, the power setting may exceed one of the modules maximum power-rating. To prevent any possible power-overshoots, the power of each module is software-limited within the acceptable range for that particular module.

**Procedure** 1. Access the **Main Setup** menu (see section *Accessing the OSICS Mainframe Main Setup Menu*, p. 33).

2. Expand the **Power** menu and enter the **Set power reference** sub-menu.

The **Power reference** sub-menu appears and displays the current power setting.

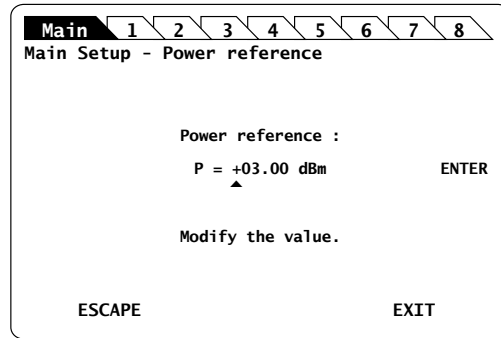

Figure 13: Main Setup – Power reference sub-menu

3. Modify the power value as follows:
  - a. Turn the rotary knob to put the cursor under the digit or +/- sign you want to modify and press the knob to highlight it.
  - b. Turn the knob clockwise to increase the value or anticlockwise to decrease it and press the knob to validate the selected digit.
  - c. Perform steps a. and b. again with the other digits to modify.
  - d. Turn the rotary knob clockwise to put the cursor under **ENTER** and press the knob to validate the new power value.

The **Main Setup** menu is automatically displayed and the optical power value of each module is now updated (according to the individual modules power limits).

## 4.3 Selecting the Spectral Unit for all Installed Modules

**Subject** The following procedure explains how to modify the spectral unit (nm or GHz) for all modules installed in the OSICS Mainframe. You cannot set the spectral unit of an individual module.

- Procedure**
1. Access the **Main Setup** menu (see section *Accessing the OSICS Mainframe Main Setup Menu*, p. 33).
  2. Turn the rotary knob to put the cursor before the **Set unit GHz/nm** menu and press the knob.

The **Set unit GHz/nm** sub-menu appears and displays the current unit setting.

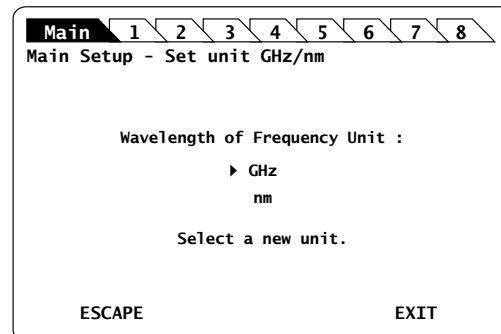

Figure 14: Main Setup – Set unit GHz/nm sub-menu

3. Turn the rotary knob to put the cursor before the wanted unit and press it to validate your selection.

The **Main Setup** menu is automatically displayed and the wavelength/frequency value of each module is set to the selected unit.

## 4.4 Configuring the OSICS Mainframe Modulation

### Presentation

The OSICS Mainframe digital modulation feature includes the following capabilities:

- **External TTL-modulation** by applying an external signal to the **Mod. in** BNC connector located at the rear panel of the OSICS Mainframe (see *Figure 2, p. 18*).
- **Internal TTL-modulation** using the built-in oscillator generating signals from 123 Hz to 1 MHz.

For details on signal levels, see section *OSICS Mainframe Technical Specifications, p. 16*. The OSICS Mainframe works as a TTL-modulated signal generator for DFB and T100 modules and also for external devices, if connected to the **Synchro** output BNC connector.

### Modulation Scheme

The modulated-signal generator of the OSICS Mainframe provides the same modulation for all the modules in a synchronous way, as illustrated in the following figure.

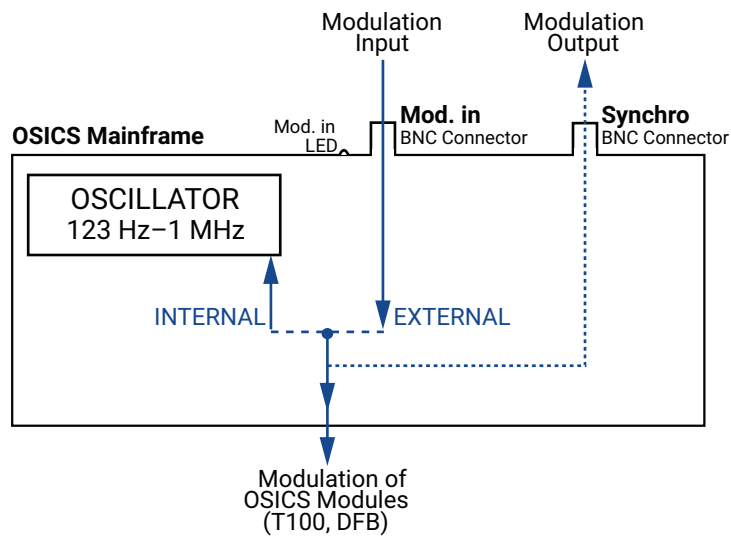

Figure 15: Mainframe Modulation Scheme

For more details on modulation of OSICS modules, see the following sections:

- DFB module: section *Configuring the OSICS DFB Signal Modulation, p. 74*
- T100 module: section *Configuring the OSICS T100 Signal Modulation, p. 152*



## 4.4.1 Setting Up Digital (TTL) Modulation Using the Mainframe Internal Source

### Subject

This modulation setting uses the OSICS Mainframe's built-in internal oscillator as a source of TTL-level modulated signals (see *Figure 15, p. 40*). The main purpose of this setting is to provide simultaneous and synchronous modulation to several modules installed in the OSICS Mainframe, or to an external device connected to the OSICS Mainframe **Synchro** output connector.

The range of the frequency of the modulation provided by the OSICS Mainframe is defined to encompass the frequency requirements of all types of OSICS modules. The frequency settings for the lower and upper bounds may therefore lie outside of the modulation capabilities of a particular module, in which case the module's own frequency range sets the modulation specifications.

The OSICS Mainframe signal generator can provide a TTL signal with a repetition frequency in the range 123 Hz–1 MHz, but for optimum modulation performance, we recommend applying modulation frequencies within the specified range of the installed modules.

### Procedure

#### Step 1 – Set the OSICS Mainframe modulation source to INTERNAL:

1. Access the **Main Setup** menu (see section *Accessing the OSICS Mainframe Main Setup Menu, p. 33*).
2. Enter the **Source** sub-menu as follows:
  - a. Turn the rotary knob to put the cursor before the **Modulation** menu and press the knob to expand it.
  - b. Turn the rotary knob to put the cursor before the **Source** sub-menu and press the knob to enter it.

The **Modulation Source** sub-menu appears and displays the current selected modulation source.

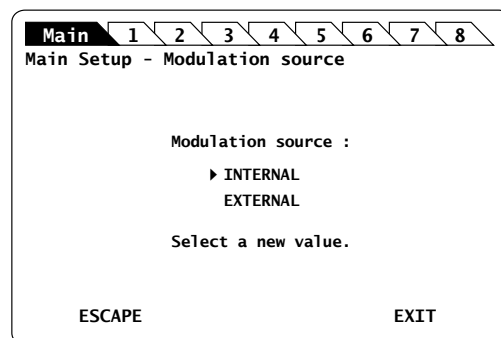

Figure 16: Main Setup – Modulation Source (Internal)

3. Turn the rotary knob to put the cursor before **INTERNAL** and press it to validate your selection.

The **Main Setup** menu is automatically displayed and the modulation is set to the selected source.

**Step 2 – Set the frequency of the OSICS Mainframe internal modulated-signal:**

1. In the **Main Setup** menu, expand the **Modulation** menu and select the **Set frequency** sub-menu.

The **Modulation frequency** sub-menu appears and displays the current selected modulation frequency-value.

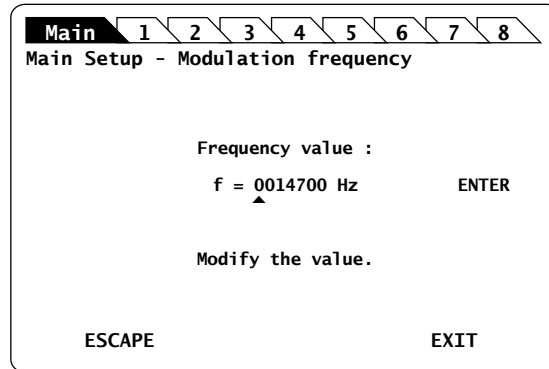

Figure 17: Main Setup – Modulation Frequency

2. Modify the frequency value as follows:

The internal TTL-signal generator can provide a TTL-modulated signal in the range 123 Hz to 1 MHz.

- a. Turn the rotary knob to put the cursor under the digit you want to modify and press the knob to highlight it.
- b. Turn the knob clockwise to increase the value or anticlockwise to decrease it and press the knob to validate the selected digit.
- c. Perform steps a. and b. again with the other digits to modify.
- d. Turn the rotary knob clockwise to put the cursor under **ENTER** and press the knob to validate the new frequency value.

The frequency is updated to the "real frequency" as shown in *Figure 18, p. 42*. This screen displays the current modulation frequency produced by the OSICS Mainframe oscillator, which may slightly differ from the values you have set.

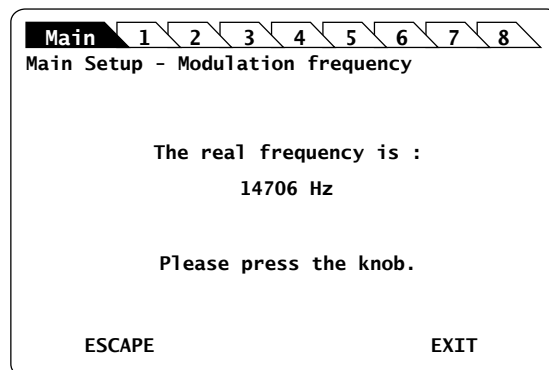

Figure 18: Main Setup – Modulation Real Frequency

3. Press the knob to go back to the **Main Setup** menu.

## 4.4.2 Setting Up Digital (TTL) Modulation Using an External Source

**Subject** External digital-modulation is achieved by applying a digital signal to the BNC **Mod. In** connector located on the OSICS Mainframe rear panel (see *Figure 15, p. 40*). This allows all the modules (or an external device connected to the OSICS Mainframe **Synchro** output connector) to be modulated in a synchronous way by means of an external source. The OSICS Mainframe distributes the external modulated-signal to all T100 and DFB installed modules in order to synchronize all modules with a single modulated signal, amplitude, and frequency.

For optimum stability of the modulated signals, we recommend applying a digital modulation in the specified range of the modules.

**Before Starting** Make sure you have a digital-signal generator.

### Procedure

#### Step 1 – Set the OSICS Mainframe modulation source to EXTERNAL:

1. Access the **Main Setup** menu (see section *Accessing the OSICS Mainframe Main Setup Menu, p. 33*).
2. Enter the **Source** sub-menu as follows:
  - a. Turn the rotary knob to put the cursor before the **Modulation** menu and press the knob to expand it.
  - b. Turn the rotary knob to put the cursor before the **Source** sub-menu and press the knob to enter it.

The **Modulation source** sub-menu appears and displays the current selected modulation source.

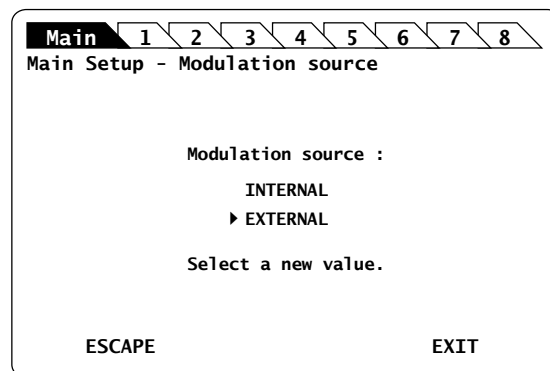

Figure 19: Main Setup – Modulation Source (External)

3. Turn the rotary knob to put the cursor before **EXTERNAL** and press it to validate your selection.

The **Main Setup** menu is automatically displayed and the modulation is set to the selected source.

#### Step 2 – Set the TTL-level signal generator:

1. On the OSICS Mainframe rear panel, connect your external digital signal-generator to the **Mod. in** BNC connector (see *Figure 2, p. 18*).

2. Apply the TTL signal not exceeding the maximum voltage of +5 V and repetition frequency between and .

The green LED located next to the **Mod. In** connector is lit to indicate that an external signal-generator is connected.

### 4.4.3 Using the Mainframe as a Modulation Source for External Devices (Synchro Output)

**Subject** On the OSICS Mainframe rear panel (see *Figure 2, p. 18*) the **Synchro** BNC output connector enables you to use the Mainframe as a modulation source for external devices.

**Procedure**

1. Set up the wanted digital modulation to the <Module Name> module using one of the following methods:
  - OSICS Mainframe internal-modulation source, as explained in section *Setting Up Digital (TTL) Modulation Using the Mainframe Internal Source, p. 41*.
  - OSICS Mainframe external-modulation source, as explained in section *Setting Up Digital (TTL) Modulation Using an External Source, p. 43*.
2. Connect the appropriate device to the **Synchro** BNC connector located on the rear panel of the OSICS Mainframe.

The selected modulation frequency is applied to the connected device.

## 5. Setting a Working Configuration

### Definitions

The working configuration is composed of the following parameters:

- The OSICS Mainframe settings
- The configuration settings of each installed OSICS module

You can save your working configuration to easily restore it at the next system startup.

The OSICS Mainframe features three types of configuration:

- **DEFAULT** configuration: the factory-set operating parameters on the OSICS Mainframe and all installed OSICS modules. You cannot modify this configuration. Default settings are listed in the following *Stored Configuration Parameters* section, p 45.
- **STARTUP** configuration: the operating parameters (on the OSICS Mainframe and all installed modules) as you left them at the system turn-off. This configuration is automatically saved when the OSICS Mainframe is turned off and automatically loaded at system startup. The first time you turn on the OSICS Mainframe, the STARTUP configuration is identical to the DEFAULT configuration. Saved parameters are listed in the following *Stored Configuration Parameters* section, p 45.
- **A, B, C and D** configurations: the operating parameters on the OSICS Mainframe and all installed modules as you decided to save them. You can save four different sets of operating parameters. Parameters you can save are listed in the following *Stored Configuration Parameters* section, p 45.

### Stored Configuration Parameters

	STARTUP/A/B/C/D Stored Settings	DEFAULT Configuration Settings
<b>OSICS Mainframe Parameters</b>	Optical output The STARTUP configuration never save the ENABLED state. For laser safety reasons, all modules are always in <b>DISABLED</b> state after system turn-on and initialization.	DISABLED
	Power unit	mW
	Power setting	0
	Spectral unit	nm (wavelength)
	Modulation source	Internal
	Frequency of the modulation source	200 Hz
	GPIB address	10

	STARTUP/A/B/C/D Stored Settings	DEFAULT Configuration Settings
<b>OSICS Module Parameters</b>	Optical output	Disabled
	Operating Mode (SWT and SWT-APC only)	<ul style="list-style-type: none"> <li>• SWT APC: Switch</li> <li>• SWT 2x(1x1): BS2S</li> <li>• SWT 1x2, 1x4: Ch1</li> <li>• SWT 2x2: Bar</li> <li>• SWT 1x1: Shut</li> </ul>
	Power unit	mW
	Power setting	<ul style="list-style-type: none"> <li>• DFB, T100: 0 mW</li> <li>• SWT, SWT APC: none</li> <li>• ATN: 55 dB (attenuation)</li> <li>• BKR: 55 dB (reflectance)</li> <li>• SLD: 5 mW</li> </ul>
	Spectral unit	nm (Wavelength)
	Wavelength/Frequency setting	<ul style="list-style-type: none"> <li>• T100: center wavelength</li> <li>• DFB: minimum wavelength</li> <li>• SWT, SWT APC: none</li> <li>• ATN, BKR: 1550 (SMF)</li> <li>• SLD: maximum wavelength</li> </ul>
	Modulation source	Internal (T100, DFB only)
	Modulation control (T100, DFB only)	OFF
	Frequency of the modulation source (T100, DFB only)	200 Hz
	Coherence Control function (T100 only)	OFF
	Auto peak find function (T100 only)	ON
	Step in menu	0.1 nm
	Step in frequency	50 GHz
	Analog out (T100, DFB only)	Power

## 5.1 Saving a Working Configuration

**Subject** Four user-defined configurations are available to save your working configuration (**A**, **B**, **C** and **D**).  
If you save your configuration on an existing one, it is replaced by the new one.

**Before Starting** Set the parameters of the OSICS Mainframe and all installed modules parameters as you want them to be saved.

**Procedure**

1. Access the **Main Setup** menu (see section *Accessing the OSICS Mainframe Main Setup Menu*, p. 33).
2. Expand the **Configuration** menu and enter the **Save** sub-menu.  
The **Save configuration** sub-menu appears and displays the configurations available for saving.

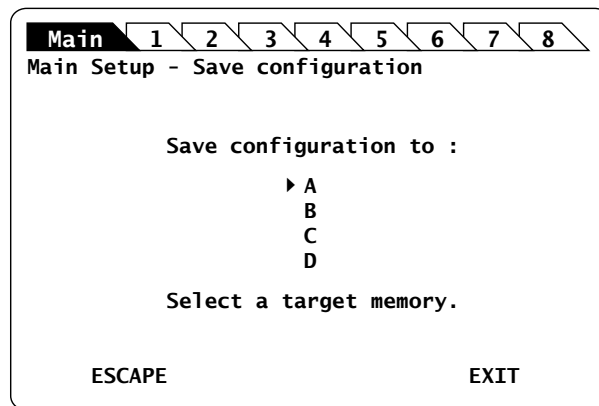

Figure 20: Main Setup – Save configuration

3. Turn the rotary knob to put the cursor before the wanted configuration name, and press it to validate your selection.

The `Saving configuration...` message appears.

When the configuration is saved, the **System Status** screen is displayed and the saved configuration is loaded.

## 5.2 Loading a Working Configuration

**Subject** You can load one of the following configuration: DEFAULT, STARTUP, A, B, C or D.

**Before Starting** Make sure you have already saved a user-defined configuration (see section *Saving a Working Configuration*, p. 47).

**Procedure**

1. Access the **Main Setup** menu (see section *Accessing the OSICS Mainframe Main Setup Menu*, p. 33).
2. Expand the **Configuration** menu and enter the **Load** sub-menu.  
The **Load configuration** sub-menu appears and displays the current configuration.

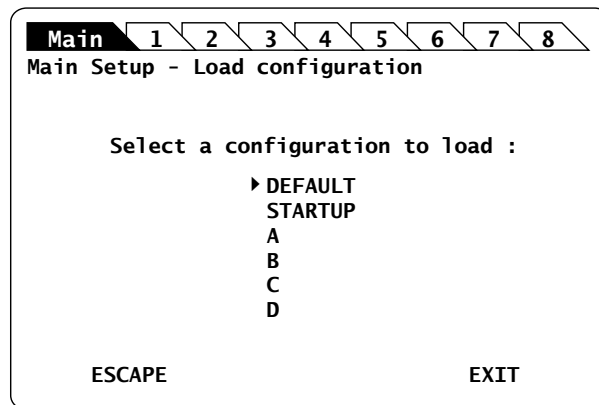

Figure 21: Main Setup – Save configuration

3. Turn the rotary knob to put the cursor before the wanted configuration name, and press it to validate your selection.

The `Moving...` message appears.

When the configuration is loaded, the **System Status** screen is displayed and the selected configuration is loaded.



## 6. Using the OSICS ATN Module

This section explains how to operate the OSICS ATN via the ATN **Unit Setup** menu. For more details on how to install and initialize the module into the OSICS Mainframe, see section *Installing and Connecting the OSICS Multifunction Platform*, p. 21.

### 6.1 OSICS ATN Presentation

The OSICS ATN is an optical attenuator module that comes in a 1x1 configuration (one input / one output).



Figure 22: ATN Configuration



#### Caution

Using the module in a reverse configuration could create higher return loss value and attenuation might not be corrected calibrated. We recommend to use the attenuator in a standard input/output configuration.

#### 6.1.1 OSICS ATN Technical Specifications

	SMF	PMF
Wavelength Range	1250–1650 nm	1440–1650 nm <sup>*1</sup> 1250–1510 nm <sup>*2</sup>
Attenuation Range	1L to 60 dB typ.	
Calibrated Range	Up to 40 dB at 1310 nm and 1550 nm	Up to 40 dB at 1550 nm <sup>*1</sup> , 1625 nm <sup>*1</sup> and 1310 nm <sup>*2</sup>
Attenuation Accuracy (typ.) <sup>*3</sup>	±0.3 dB	
Insertion Loss	< 2 dB (1 dB typ.)	
Attenuation Setting Resolution	0.1 dB (Display resolution: 0.01 dB)	
Polarization Dependent Loss <sup>*4</sup>	< 0.1 dB	
PER	n/a	≥ 18 dB
Return Loss <sup>*5</sup>	> 50 dB	
Maximum Input Power	2 W (+33 dBm)	
Optical Connectors <sup>*6</sup>	FC/APC narrow key	

Specifications apply for wavelengths not equal to any water absorption line.

\*1: On PM15 fiber.

- \*2: On PM13 fiber.
- \*3: Inside calibrated range.
- \*4: Total PDL including both FC-APC connectors.
- \*5: RL at 1550 nm for SMF & PM15, RL at 1310 nm for PM13.
- \*6: PMF: slow axis is aligned to the connector key.

## 6.1.2 OSICS ATN Module Overview

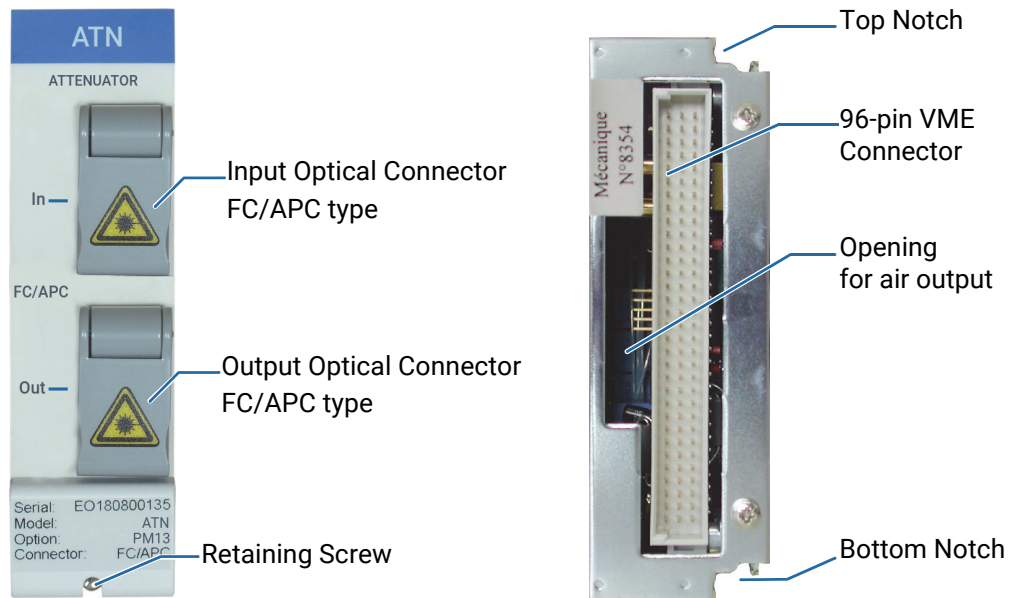

Figure 23: ATN Module – Front and Rear Panels

### Front Panel

#### Optical Connectors

Fiber optic connectors are standard input/output FC/APC type connectors (narrow key). For more details on the appropriate fiber type and laser power compatibility, see section *OSICS ATN Technical Specifications, p. 49*.



#### Caution

If you use high power lasers (> 500 mW), please be aware of risks and procedures needed to handle such high power. Make sure optical connections are perfectly clean to avoid any dust that will result in permanent damage of the optical connector (see section *Cleaning Optical Connectors, p. 174*). Warranty will not apply in case of burnt connectors.



The  label located on the optical output connector cap indicates the location of the laser output.



#### Warning

The use of optical instruments with this product increases eye hazard. Do not look directly into the fiber end of an optical cable connected to any optical output while the device is in use. This may cause permanent eye damage.

### Retaining Screw

The captive screw enables you to lock/unlock the module inserted into the slot of the OSICS Mainframe.



#### Caution

The OSICS Mainframe does not support "hot-swap" of modules; for more details, see section *Handling OSICS Modules Into the OSICS Mainframe*, p. 23).

## Rear Panel

### Notches

The top and bottom notches enable you to slide the module into the OSICS Mainframe slot (see section *Installing an OSICS Module Into the OSICS Mainframe*, p. 23).

### 96-pin VME Connector

The rear panel of the OSICS modules interfaces with the OSICS Mainframe backplane by means of the 96-pin VME connector.

### Opening

The opening ensures proper flow of cooled air drawn from the OSICS Mainframe chassis.

## Side Panel

The labels affixed on the side panel of the OSICS ATN are described in section *OSICS Information and Warning Markings*, p. 19.

## 6.2 Setting the OSICS ATN Optical Attenuation

You can change the optical attenuation for each module individually using the **ATN Unit Setup** menu.

You can configure the total attenuation using one of the following method:

- Setting the attenuation to a definite value: see section *Setting the Attenuation to a Definite Value*, p. 52
- Adjusting the power level in real-time: see section *Performing Real-time Adjustments to the ATN Attenuation*, p. 53

### 6.2.1 Setting the Attenuation to a Definite Value

#### Procedure

1. Access the **ATN Unit Setup** menu (see section *Accessing an OSICS Module Setup Menu*, p. 33).
2. Turn the rotary knob to put the cursor before the **Set Attenuation** menu and press the knob.

The **Set Attenuation** menu appears and displays the current attenuation setting.

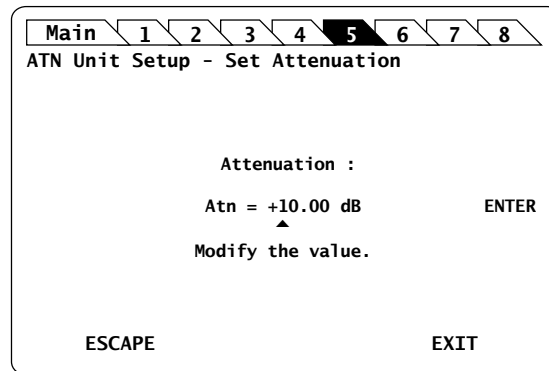

Figure 24: ATN Unit Setup – Set Attenuation menu

3. Modify the value as follows:
  - a. Turn the rotary knob to put the cursor under the digit you want to modify and press the knob to highlight it.
  - b. Turn the knob clockwise to increase the value or anticlockwise to decrease it and press the knob to validate the selected digit.
  - c. Perform steps a. and b. again with the other digits to modify.
  - d. Turn the rotary knob clockwise to put the cursor under **ENTER** and press the knob to validate the new value.

The **Unit Setup** menu is automatically displayed and the optical attenuation is now set.

## 6.2.2 Performing Real-time Adjustments to the ATN Attenuation

**Subject** The **Adjust Attenuation** feature lets you adjust the attenuation of the ATN module in real-time (within the accuracy determined by the smallest decimal-digit of the power value).

- Procedure**
1. Access the **ATN Unit Setup** menu (see section *Accessing an OSICS Module Setup Menu*, p. 33).
  2. Turn the rotary knob to put the cursor before the **Adjust Attenuation** menu and press the knob.

The **Adjust Attenuation** menu appears and displays the current attenuation setting.

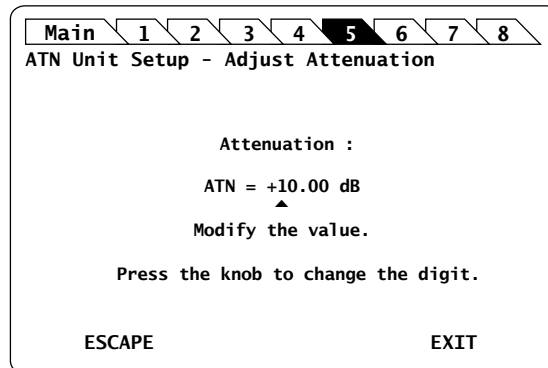

Figure 25: ATN Unit Setup – Adjust Attenuation menu

3. To change the attenuation of the ATN module in real-time:
  - a. Turn the rotary knob to put the cursor under the digit you want to modify and press the knob to highlight it.
  - b. Turn the knob clockwise to increase the value or anticlockwise to decrease it and press the knob to validate the selected digit. Rotating the knob increments or decrements the digit above the cursor. Going above "9" increases the next significant digit; going below "0" decreases the next significant digit.
  - c. Perform steps a. and b. again with the other digits to modify.

The ATN module attenuation is modified in real-time.
4. Press one of the following control buttons:
  - **ESCAPE**: to validate the displayed value and go back to the **ATN Unit Setup** menu.
  - **EXIT**: to display the **System Status** screen.

## 6.2.3 Step-Adjusting the ATN Attenuation

**Subject** The following procedure explains how to modify the attenuation step by step using the attenuation increment defined in the **Set Step** menu.

The initial attenuation value is originally defined in the **Set Attenuation** menu (see section *Setting the Attenuation to a Definite Value, p. 52*).

**Before Starting** Verify the selected attenuation value (see section *Setting the Attenuation to a Definite Value, p. 52*)

**Procedure** 1. Access the **ATN Unit Setup** menu (see section *Accessing an OSICS Module Setup Menu, p. 33*).

2. Expand the **Step** menu and enter the **Set Step** sub-menu.

The **Set Step** sub-menu appears and displays the current value of the attenuation step in dB.

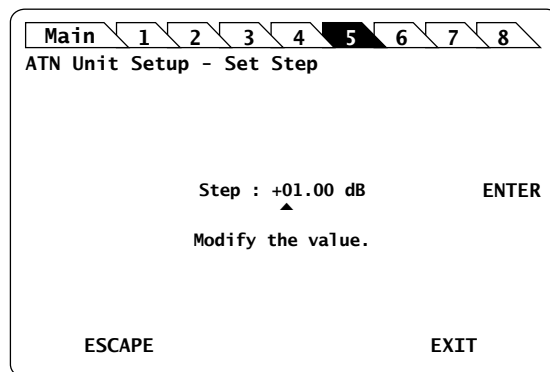

Figure 26: ATN Unit Setup – Set Step sub-menu

3. Modify the step value as follows:

- Turn the rotary knob to put the cursor under the digit you want to modify and press the knob to highlight it.
- Turn the knob clockwise to increase the value or anticlockwise to decrease it and press the knob to validate the selected digit.
- Perform steps a. and b. again with the other digits to modify.
- Turn the rotary knob clockwise to put the cursor under **ENTER** and press the knob to validate the new step value.

The **ATN Unit Setup** menu is automatically displayed.

4. To modify the wavelength/frequency defined in the **Set Attenuation** menu (see section *Setting the Attenuation to a Definite Value, p. 52*), expand the **Step** menu, move the cursor before the **Step +** or **Step -** sub-menus and press the knob to step-adjust the value.

5. Repeat step 4. until the wanted attenuation value is reached.

## 6.3 Setting the ATN Wavelength

**Subject** The **Set  $\lambda$ /f** menu enables you to set the reference wavelength. Each module is factory-calibrated at different wavelengths depending on the module version (SMF or PMF): see section *OSICS ATN Technical Specifications*, p. 49.

**Procedure**

1. Access the **ATN Unit Setup** menu (see section *Accessing an OSICS Module Setup Menu*, p. 33).
2. Turn the rotary knob to put the cursor before the **Set  $\lambda$ /f** menu and press the knob. The **Set Wavelength/Set Frequency** menu appears and displays the current value of wavelength or frequency according to the selected unit.

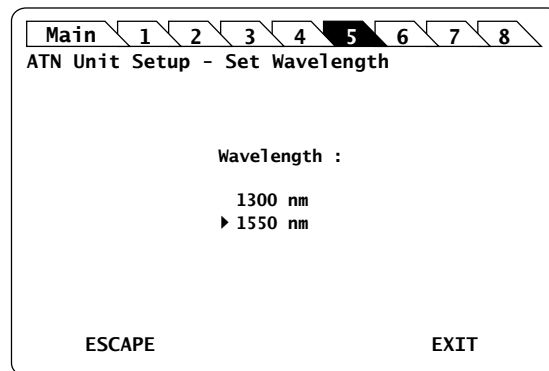

Figure 27: ATN Unit Setup – Set Wavelength menu

3. Turn the rotary knob to put the cursor before the wanted value and press it to validate your selection.

The **Unit Setup** menu is automatically displayed and the wavelength/frequency value is now set.

## 6.4 Setting the ATN Attenuation Offset

### Subject

Two independent offset can be set for the two calibrated wavelengths.

The final attenuation of the module is given by the following formula:

Total attenuation = <Attenuation setting> - <offset>

The offset can be set between -10 dB and +10 dB with a 0.01 dB step.

If the offset is different from 0, then the  $\circ$  character appears in the **Info** column of the System Status screen (see *Figure 9, p. 30*).

If an offset is set, the attenuation setting is adjustable from <insertion loss> + <offset value> to 60 dB + <offset value>

### Procedure

1. Access the **ATN Unit Setup** menu (see section *Accessing an OSICS Module Setup Menu, p. 33*).
2. Turn the rotary knob to put the cursor before the **Offset** menu and press the knob. The **Set Offset** menu appears and displays the current selected wavelength and offset.

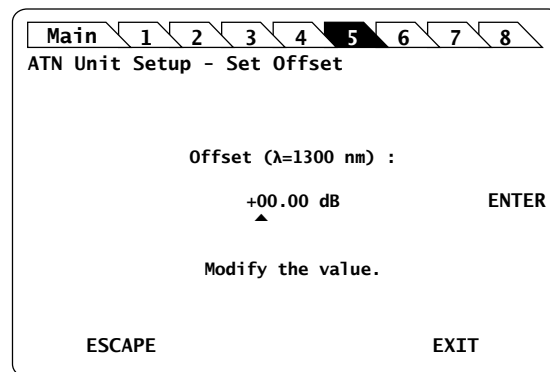

Figure 28: ATN Unit Setup – Set Offset menu

3. Modify the offset value as follows:
  - a. Turn the rotary knob to put the cursor under the digit you want to modify and press the knob to highlight it.
  - b. Turn the knob clockwise to increase the value or anticlockwise to decrease it and press the knob to validate the selected digit.
  - c. Perform steps a. and b. again with the other digits to modify.
  - d. Turn the rotary knob clockwise to put the cursor under **ENTER** and press the knob to validate the new step value.

The **ATN Unit Setup** menu is automatically displayed and the offset set to the selected value.



## 7. Using the OSICS BKR Module

This section explains how to operate the OSICS BKR via the BKR **Unit Setup** menu. For more details on how to install and initialize the module into the OSICS Mainframe, see section *Installing and Connecting the OSICS Multifunction Platform*, p. 21.

### 7.1 OSICS BKR Presentation

The OSICS BKR module is an optical variable reflector that generates known values of reflectance and operates throughout a large wavelength range.

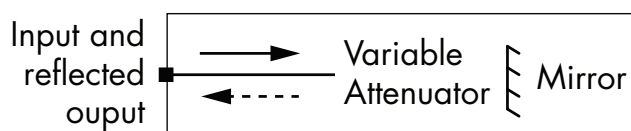

Figure 29: OSICS BKR Principle

#### 7.1.1 OSICS BKR Technical Specifications

	OSICS BKR
Wavelength Range	1250–1650 nm on SMF 1240–1520 nm on PMF
Reflectance Range	Up to 55 dB
Calibrated Range	Up to 40 dB at 1310 and 1550 nm
Reflectance Accuracy (typ.) <sup>*1</sup>	±0.3 dB
Insertion Loss	≤ 4 dB (3 dB typ.)
Reflection Setting Resolution <sup>*2</sup>	0.1 dB (Display resolution: 0.01 dB)
Polarization Dependent Loss	0.2 dB
Speed	0.1 second / 3 dB (typ.)
Maximum Input Power	0.2 W (+23 dBm)
Optical Connectors	FC-APC on SMF-28 FC-APC on PMF PM13

All specifications are tested at 23°C +/- 2°C; optical connector included.

\*1: Inside calibrated range and up to 35 dB.

\*2: From 1 dB to 10 dB; 0.3 dB for 10 dB to 20 dB

## 7.1.2 OSICS BKR Module Overview

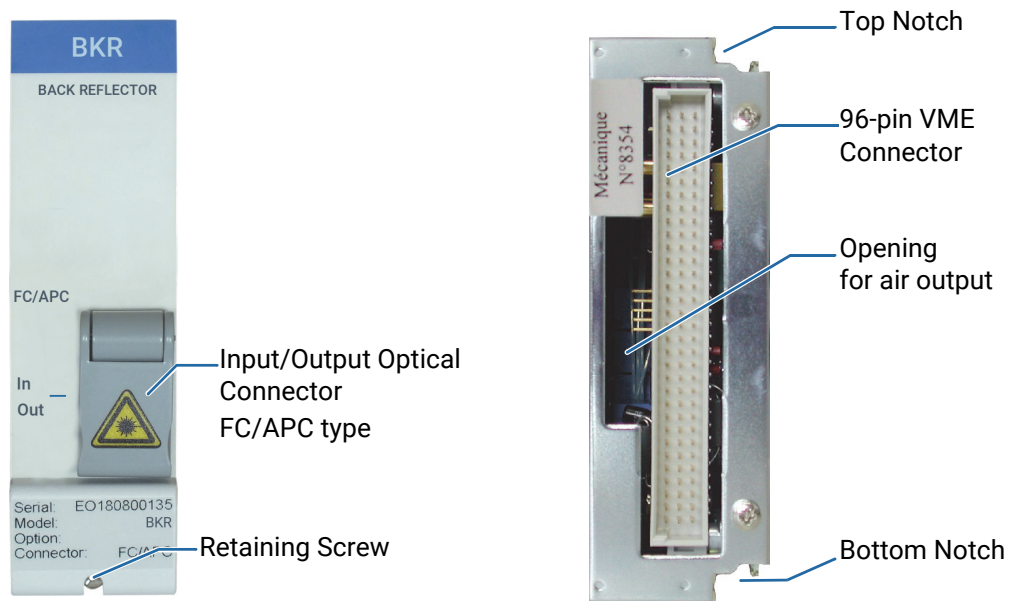



Figure 30: OSICS BKR Module – Front and Rear Panels

### Front Panel

#### Optical Connectors

The fiber optic connector is standard input/output FC/APC type connectors (narrow key). For more details on the appropriate fiber type and laser power compatibility, see section *OSICS BKR Technical Specifications, p. 57*.

The  label located on the optical output connector cap indicates the location of the laser source.



#### Warning

The use of optical instruments with this product increases eye hazard. Do not look directly into the fiber end of an optical cable connected to any optical output while the device is in use. This may cause permanent eye damage.

#### Retaining Screw

The captive screw enables you to lock/unlock the module inserted into the slot of the OSICS Mainframe.



#### Caution

The OSICS Mainframe does not support "hot-swap" of modules; for more details, see section *Handling OSICS Modules Into the OSICS Mainframe, p. 23*.

### Rear Panel

#### Notches

The top and bottom notches enable you to slide the module into the OSICS Mainframe slot (see section *Installing an OSICS Module Into the OSICS Mainframe, p. 23*).

**96-pin VME Connector**

The rear panel of the OSICS modules interfaces with the OSICS Mainframe backplane by means of the 96-pin VME connector.

**Opening**

The opening ensures proper flow of cooled air drawn from the OSICS Mainframe chassis.

**Side Panel**

The labels affixed on the side panel of the OSICS BKR are described in section *OSICS Information and Warning Markings*, p. 19.

## 7.2 Setting the OSICS BKR Optical Reflectance

You can change the optical reflectance for each module individually using the OSICS BKR **Unit Setup** menu.

You can configure the total attenuation using one of the following method:

- Setting the reflectance to a definite value: see section *Setting the Reflectance to a Definite Value*, p. 59
- Adjusting the reflectance level in real-time: see section *Performing Real-time Adjustments to the BKR Reflectance*, p. 60

### 7.2.1 Setting the Reflectance to a Definite Value

**Procedure**

1. Access the BKR **Unit Setup** menu (see section *Accessing an OSICS Module Setup Menu*, p. 33).
2. Turn the rotary knob to put the cursor before the **Set Attenuation** menu and press the knob.

The **Set Attenuation** menu appears and displays the current reflectance setting.

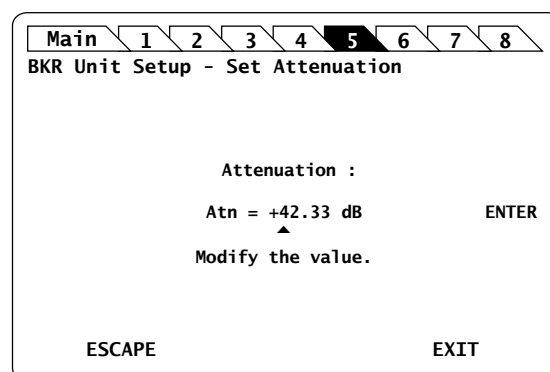

Figure 31: BKR Unit Setup – Set Attenuation menu

3. Modify the value as follows:
  - a. Turn the rotary knob to put the cursor under the digit you want to modify and press the knob to highlight it.
  - b. Turn the knob clockwise to increase the value or anticlockwise to decrease it and press the knob to validate the selected digit.
  - c. Perform steps a. and b. again with the other digits to modify.

- d. Turn the rotary knob clockwise to put the cursor under **ENTER** and press the knob to validate the new value.

The **Unit Setup** menu is automatically displayed and the optical reflectance is now set.

## 7.2.2 Performing Real-time Adjustments to the BKR Reflectance

**Subject** The **Adjust Attenuation** feature lets you adjust the attenuation of the BKR module in real-time (within the accuracy determined by the smallest decimal-digit of the power value).

**Procedure**

1. Access the BKR **Unit Setup** menu (see section *Accessing an OSICS Module Setup Menu*, p. 33).
2. Turn the rotary knob to put the cursor before the **Adjust Attenuation** menu and press the knob.

The **Adjust Attenuation** menu appears and displays the current reflectance setting.

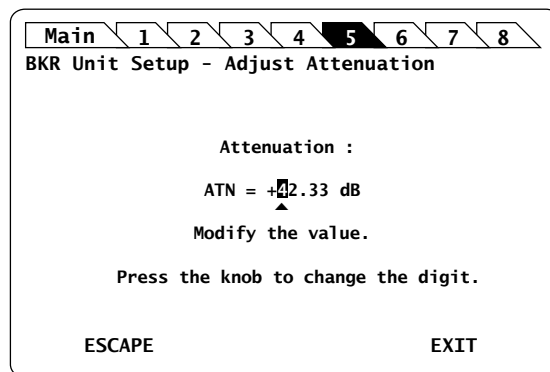

Figure 32: BKR Unit Setup – Adjust Attenuation menu

3. Modify the value as follows, to update the BKR module reflectance in real-time:
  - a. Turn the rotary knob to put the cursor under the digit you want to modify and press the knob to highlight it.
  - b. Turn the knob clockwise to increase the value or anticlockwise to decrease it and press the knob to validate the selected digit. Rotating the knob increments or decrements the digit above the cursor. Going above "9" increases the next significant digit; going below "0" decreases the next significant digit.
  - c. Perform steps a. and b. again with the other digits to modify. The BKR module attenuation is modified in real-time.
4. Press one of the following control buttons:
  - **ESCAPE**: to validate the displayed value and go back to the **BKR Unit Setup** menu.
  - **EXIT**: to display the **System Status** screen.

## 7.2.3 Step-Adjusting the BKR Attenuation

**Subject** The following procedure explains how to modify the reflectance step by step using the reflectance increment defined in the **Set Step** menu.

The initial reflectance value is originally defined in the **Set Attenuation** menu (see section *Setting the Reflectance to a Definite Value, p. 59*).

**Before Starting** Verify the selected reflectance value (see section *Setting the Reflectance to a Definite Value, p. 59*)

**Procedure** 1. Access the BKR **Unit Setup** menu (see section *Accessing an OSICS Module Setup Menu, p. 33*).

2. Expand the **Step** menu and enter the **Set Step** sub-menu.

The **Set Step** sub-menu appears and displays the current value of the reflectance step in dB.

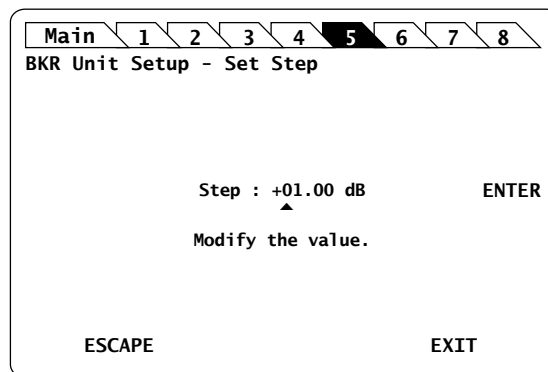

Figure 33: BKR Unit Setup – Set Step sub-menu

3. Modify the step value as follows:
  - a. Turn the rotary knob to put the cursor under the digit you want to modify and press the knob to highlight it.
  - b. Turn the knob clockwise to increase the value or anticlockwise to decrease it and press the knob to validate the selected digit.
  - c. Perform steps a. and b. again with the other digits to modify.
  - d. Turn the rotary knob clockwise to put the cursor under **ENTER** and press the knob to validate the new step value.

The BKR **Unit Setup** menu is automatically displayed.

4. To modify the wavelength/frequency defined in the **Set Attenuation** menu (see section *Setting the Reflectance to a Definite Value, p. 59*), expand the **Step** menu, set the cursor before the **Step +** or **Step -** sub-menus and press the knob to step-adjust the value.
5. Repeat step 4. until the wanted reflectance value is reached.

## 7.3 Setting the BKR Wavelength/Frequency

**Subject** The **Set  $\lambda$ /f** menu enables you to set the reference wavelength. Each module is factory-calibrated at different wavelengths depending on the module version (SMF or PMF): see section *OSICS BKR Technical Specifications*, p. 57.

**Procedure**

1. Access the BKR **Unit Setup** menu (see section *Accessing an OSICS Module Setup Menu*, p. 33).
2. Turn the rotary knob to put the cursor before the **Set  $\lambda$ /f** menu and press the knob.  
The **Set Wavelength/Set Frequency** menu appears and displays the current value of wavelength or frequency according to the selected unit.

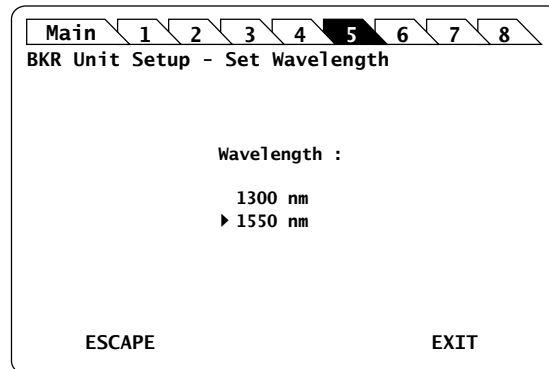

Figure 34: BKR Unit Setup – Set Wavelength menu

3. Turn the rotary knob to put the cursor before the wanted value and press it to validate your selection.

The **Unit Setup** menu is automatically displayed and the wavelength/frequency value is now set.

## 7.4 Setting the BKR Attenuation Offset

### Subject

Two independent offsets can be set for the two calibrated wavelengths./frequencies. The final reflectance of the module is given by the following formula:

Total reflectance = <Reflectance setting> - <offset>

The offset can be set between -10 dB and +10 dB with a 0.01 dB resolution.

If the offset is different from 0, then the  $\circ$  character appears in the **Info** column of the System Status screen (see *Figure 9, p. 30*)

If an offset is set, the reflectance setting is adjustable from <insertion loss> + <offset value> to 55 dB + <offset value>

### Procedure

1. Access the **BKR Unit Setup** menu (see section *Accessing an OSICS Module Setup Menu, p. 33*).
2. Expand the **Offset** menu and enter one of the calibrated wavelengths/frequencies. The **Set Offset** menu appears and displays the current selected wavelength/frequency and offset.

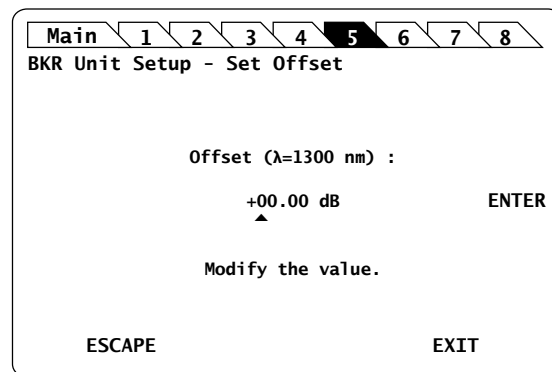

Figure 35: BKR Unit Setup – Set Offset menu

3. Modify the offset value as follows:
  - a. Turn the rotary knob to put the cursor under the digit you want to modify and press the knob to highlight it.
  - b. Turn the knob clockwise to increase the value or anticlockwise to decrease it and press the knob to validate the selected digit.
  - c. Perform steps a. and b. again with the other digits to modify.
  - d. Turn the rotary knob clockwise to put the cursor under **ENTER** and press the knob to validate the new step value.

The **BKR Unit Setup** menu is automatically displayed and the offset set to the selected value.





## 8. Using the OSICS DFB Module

This section explains how to operate the OSICS DFB via the DFB **Unit Setup** menu. For more details on how to install and initialize the module into the OSICS Mainframe, see section *Installing and Connecting the OSICS Multifunction Platform*, p. 21.

### 8.1 OSICS DFB Presentation

The OSICS DFB is a distributed feedback laser diode module designed for fiber-optic component and system testing.

Emission wavelengths are factory-set on user-selected wavelength. The center wavelength is chosen at the time of order to match one of the ITU-T grid channels. For additional flexibility, the center-wavelength can be finely tuned (see section *OSICS DFB Technical Specifications*, p. 65).

#### 8.1.1 OSICS DFB Technical Specifications

		CWDM SMF	CWDM PM13	CWDM PM15	DWDM PM15	LANWDM SMF	LANWDM PM13
<b>Models</b>	Channels	See <i>OSICS DFB Datasheets</i>					
	Wavelength of first channel	1270 nm	1310 nm	1450 nm	1529.553 nm	1295.56 nm / 231.4 THz	
	Wavelength of last channel	1650 nm		1650 nm	1611.787 nm	1309.14 nm / 229.0 THz	
<b>Wavelength</b>	Channel center	wavelength grid $\pm 3$ nm			Grid matched		
	Tuning range <sup>*1</sup>	1.6 nm (1.8 nm typ.)					
	Accuracy <sup>*2</sup>	$\pm 0.03$ nm					
	Stability over 1 hour <sup>*2,*3,*4</sup>	$\pm 0.005$ nm					
	Stability over 24 hours <sup>*2,*3,*4</sup>	$\pm 0.005$ nm typ.					
<b>Power</b>	Maximum	10 mW (for channels from 1270 to 1570 nm) 8 mW (for channels from 1590 to 1650 nm)			+13 dBm	10 mW	
	Stability over 1 hour <sup>*2,*3,*4</sup>	$\pm 0.01$ dB					
	Stability over 24 hours <sup>*2,*3,*4</sup>	$\pm 0.01$ dB typ.					
	Optical Isolation	> 30 dB					
	RIN <sup>*5</sup> (Relative Intensity Noise)	< -140 dB/Hz				< -130 dB/Hz	
<b>Spectrum</b>	Laser line width	< 10 MHz					
	SMSR <sup>*2</sup> (Side Mode Suppression Ratio)	> 30 dB (40 dB typ.)			> 35 dB (45 dB typ.)	> 30 dB (40 dB typ.)	

			CWDM SMF	CWDM PM13	CWDM PM15	DWDM PM15	LANWDM SMF	LANWDM PM13
<b>Modulation</b>	TTL	Internal	1 Hz to 890 kHz				1 Hz to 890 kHz	
		External					16 Hz to 890 kHz	
	Analog (external/front panel)		150 Hz to 150 MHz					
	SBS Suppression (internal)*6	Waveform	sine					
		Frequency Range	10 kHz to 100 kHz					
	Modulation Depth	0 to 15%						
<b>Interfaces on Module Front Panel</b> *7	Enable key with status LED		Power up laser					
	Optical connector		FC/APC narrow key					
	Optical fiber		SMF	PM13	PM15		SMF	PM13
	Fiber alignment to connector key		n/a	Slow axis			n/a	Slow axis
	PER (Polarization Extinction Ratio)		n/a	> 17 dB			SMF	>17 dB
	Electrical connector (analog modulation)		Coaxial SMB – 50 Ω					
<b>Others</b>	Laser safety		Class 1 M					
	Dimensions (WxHxD)		35 x 128 x 230 mm					
	Weight		1.1 kg					

\*1: For DFB DWDM and LANWDM: Location of channel center: lower boundary of the range + 0.4 nm < channel center < upper boundary of the range - 0.4 nm.

\*2: After warm-up and at maximum power.

\*3: At a constant temperature.

\*4: Measured with an APC terminated jumper on a powermeter.

\*5: RIN within the range 100 MHz–20 GHz measured at 10 dBm output power with RBW = 30 kHz.

\*6: SBS = Stimulated Brillouin Scattering.

\*7: See OSICS Mainframe Data Sheet for details on OSICS common specifications and interfaces on the rear panel.

## 8.1.2 OSICS DFB Module Overview

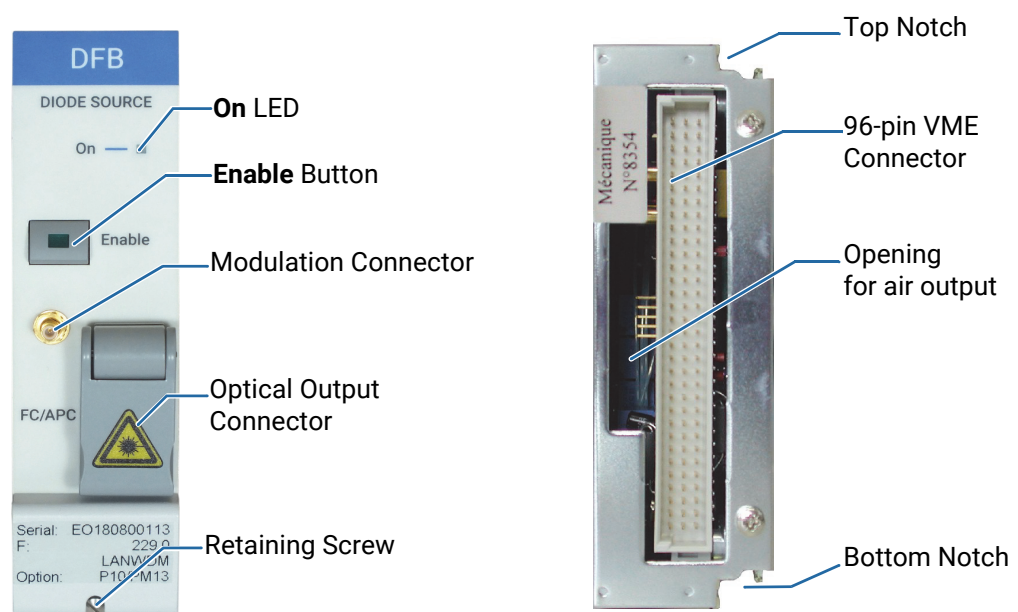

Figure 36: DFB Module – Front and Rear Panels

### Front Panel

#### On LED

This LED indicates that the module is turned on (see section *Turning on the OSICS Multifunction Platform and Accessing the System Status Screen*, p. 29).

#### Enable Button

This button enables you to turn on/off the laser inside the module. The green LED of the button is lit if the optical output is enabled, and the power value is displayed in the System Status screen (see section *System Status Screen Description*, p. 30).

#### Modulation Input Connector (Coaxial SMB type)

This connector enables you to directly modulate the laser diode chip of the module (see section *Setting Up Analog Modulation Using an External Source*, p. 83).

#### Optical Output Connector

The standard output connector is a FC/APC type connector.

For more details on the appropriate fiber type, see section *OSICS DFB Technical Specifications*, p. 65.

The  label located on the optical output connector cap indicates the location of the laser source.



#### Warning

Do not look directly into the fiber end of an optical cable connected to any optical output while the device is in use. This may cause permanent eye damage.

### Retaining Screw

The captive screw enables you to lock/unlock the module inserted into the slot of the OSICS Mainframe.



#### Caution

The OSICS Mainframe does not support "hot-swap" of modules; for more details, see section *Handling OSICS Modules Into the OSICS Mainframe, p. 23*.

### Rear Panel

#### Notches

The top and bottom notches enable you to slide the module into the OSICS Mainframe slot (see section *Installing an OSICS Module Into the OSICS Mainframe, p. 23*).

#### 96-pin VME Connector

The rear panel of the OSICS modules interfaces with the OSICS Mainframe backplane by means of the 96-pin VME connector.

#### Opening

The opening ensures proper flow of cooled air drawn from the OSICS Mainframe chassis.

### Side Panel

The labels affixed on the side panel of the OSICS DFB are described in section *OSICS Information and Warning Markings, p. 19*.

## 8.2 Enabling/Disabling the Light Source of the Module

### Subject

You can enable/disable the light source in two different ways:

- From the OSICS Mainframe **Main Setup** menu (see section *Enabling/Disabling the Light Source of All Modules, p. 37*), you can simultaneously enable or disable the light source in all the modules installed in the OSICS Mainframe. This function overrides the enable/disable state individually set in all modules.
- From the DFB front panel, you can individually enable or disable the light source of the module by using the **Enable** button as explained in the following procedure. This action does not affect the enable/disable state of other modules installed in the OSICS Mainframe.

For laser safety reasons, the light source in modules are disabled after OSICS initialization.

### Before Starting

Connect an optical device to the OSICS module (see section *Connecting Optical Devices to OSICS Modules, p. 26*).



#### Warning

- Do not enable the laser while there is no fiber connected to the optical output connector.
- Do not look directly into the fiber end of an optical cable connected to any optical output while the device is in use. This may cause permanent eye damage.

### Procedures

#### Enabling the Light Source of the Module

- On the DFB module front panel press the **Enable** button.

The green LED on the button is lit.

In the **System Status** screen, the output power is displayed in the **P** field (in dBm or mW depending on the selected power unit) for the corresponding module.

#### Disabling the Light Source of the Module

- On the DFB module front panel press the **Enable** button.

The green LED on the button is turned off.

In the **System Status** screen, the message **Disabled** is displayed for the corresponding module.

## 8.3 Setting the Optical Output Power of the DFB Module

### 8.3.1 Specifying the Optical Output Power of the Module

#### Subject

You can set the optical output power in two different ways:

- From the OSICS Mainframe **Main Setup** menu, you can simultaneously set the optical power of all modules to the same value: see section *Setting the Optical Output Power of All Installed Modules*, p. 38.
- From the DFB **Unit Setup** menu, you can set the output power of the module individually as explained in the following procedure.

The power value is software-limited to stay within the specified range.

#### Before Starting

- Set the optical power unit from the OSICS Mainframe **Main Setup** menu (see section *Selecting the Power Unit for All Installed Modules*, p. 38). You cannot set the power unit of an individual module.

#### Procedure

1. Access the DFB **Unit Setup** menu (see section *Accessing an OSICS Module Setup Menu*, p. 33).
2. Turn the rotary knob to put the cursor before the **Set Power** menu and press the knob.

The **Set Power** menu appears and displays the current power setting.

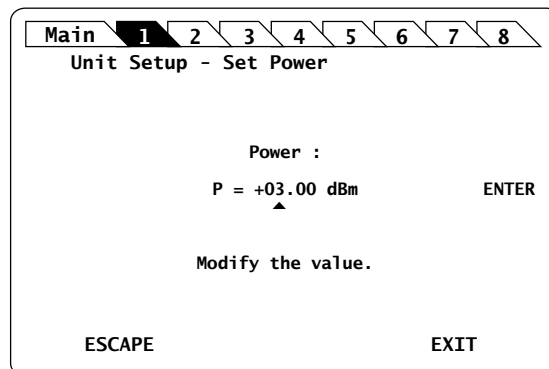

Figure 37: DFB Unit Setup – Set Power menu

3. Modify the power value as follows:
  - a. Turn the rotary knob to put the cursor under the digit of +/- sign you want to modify and press the knob to highlight it.
  - b. Turn the knob clockwise to increase the value or anticlockwise to decrease it and press the knob to validate the selected digit.
  - c. Perform steps a. and b. again with the other digits to modify.
  - d. Turn the rotary knob clockwise to put the cursor under **ENTER** and press the knob to validate the new power value.

The **Unit Setup** menu is automatically displayed and the optical power value of the module is now modified (according to the module power limits).

## 8.3.2 Performing Real-time Adjustments to the Output Power

- Subject** The following procedure explains how to adjust the output power of the module in real-time (within the accuracy determined by the smallest decimal-digit of the power value). The starting power is the value defined in the **Set Power** menu.
- Before Starting** Enable the optical output of the module (see section *Enabling/Disabling the Light Source of the Module*, p. 69).
- Procedure**
1. Access the DFB **Unit Setup** menu (see section *Accessing an OSICS Module Setup Menu*, p. 33).
  2. Turn the rotary knob to put the cursor before the **Adjust Power** menu and press the knob.
- The **Adjust Power** menu appears and displays the current power setting, with the first digit highlighted.

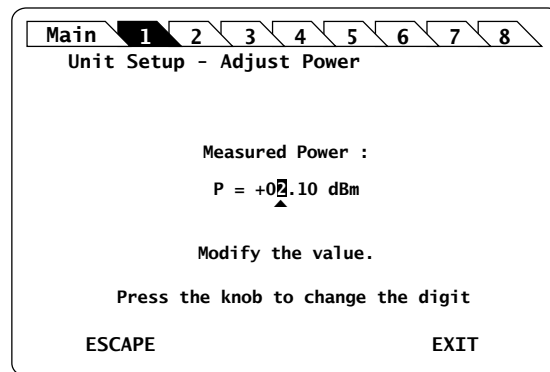

Figure 38: DFB Unit Setup – Adjust Power menu

3. Adjust the power value as follows:
  - a. Turn the knob clockwise to increase the digit value or anticlockwise to decrease it and press the knob to validate the selected digit. Rotating the knob increments or decrements the digit above the cursor. Going above "9" increases the next significant digit; going below "0" decreases the next significant digit.
  - b. Perform steps a. and b. again with the other digits to modify.

The module output power is updated in real time when you change the value in this menu.
4. Press one of the following control buttons:
  - **ESCAPE**: to validate the displayed value and go back to the DFB **Unit Setup** menu.
  - **EXIT**: to display the **System Status** screen.

The optical power value of the module is now modified (according to the module power limits).

## 8.4 Setting the Optical Emission Wavelength/Frequency

### 8.4.1 Specifying the Optical Emission Wavelength/Frequency

**Subject** The following procedure explains how to set the emission wavelength or optical frequency of the OSICS DFB module according to its specifications. Even though the module lets you set wavelength values outside this range, performance of your module is guaranteed only within the wavelength range established by the module specifications

**Before Starting**

- Set the spectral unit from the OSICS Mainframe **Main Setup** menu (see section *Selecting the Spectral Unit for all Installed Modules, p. 39*). You cannot set the spectral unit of an individual module.

**Procedure**

- Access the DFB **Unit Setup** menu (see section *Accessing an OSICS Module Setup Menu, p. 33*).
- Turn the rotary knob to put the cursor before the **Set  $\lambda$ /f** menu and press the knob. The **Set Wavelength** menu appears and displays the emission wavelength or frequency.

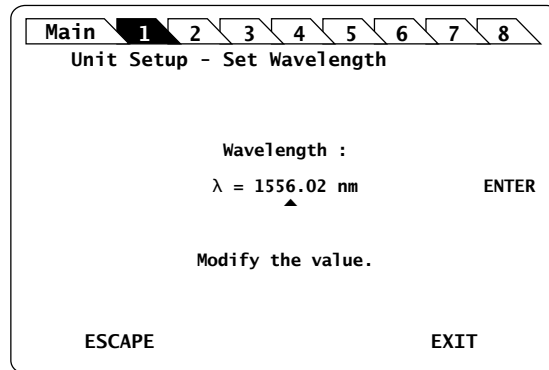

Figure 39: DFB Unit Setup – Set Wavelength/Frequency menu

- Modify the wavelength/frequency value as follows:
  - Turn the rotary knob to put the cursor under the digit you want to modify and press the knob to highlight it.
  - Turn the knob clockwise to increase the value or anticlockwise to decrease it and press the knob to validate the selected digit.
  - Perform steps a. and b. again with the other digits to modify.
  - Turn the rotary knob clockwise to put the cursor under **ENTER** and press the knob to validate the new wavelength value.

The **Unit Setup** menu is automatically displayed and the wavelength/frequency value of the module is now modified (according to the module limits).



## 8.4.2 Step-adjusting the Wavelength/Frequency Value of the Module

### Subject

The following procedure explains how to modify the wavelength/frequency of the module step by step using the increment defined in the **Set Step** sub-menu.

You can define a valid step value within the range 0.001–2.000 nm.

The starting wavelength is the value originally defined in the **Set  $\lambda$ f** menu (see section *Specifying the Optical Emission Wavelength/Frequency*, p. 72).

### Procedure

1. Access the DFB **Unit Setup** menu (see section *Accessing an OSICS Module Setup Menu*, p. 33).

2. Expand the **Step** menu and enter the **Set Step** sub-menu.

The **Set Step** sub-menu appears and displays the current value of the wavelength/frequency step in nm or GHz .

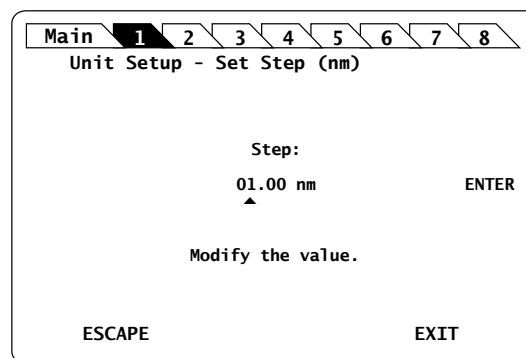

Figure 40: DFB Unit Setup – Set Step sub-menu

3. Modify the step value as follows:
  - a. Turn the rotary knob to put the cursor under the digit you want to modify and press the knob to highlight it.
  - b. Turn the knob clockwise to increase the value or anticlockwise to decrease it and press the knob to validate the selected digit.
  - c. Perform steps a. and b. again with the other digits to modify.
  - d. Turn the rotary knob clockwise to put the cursor under **ENTER** and press the knob to validate the new wavelength value.

The **Unit Setup** menu is automatically displayed.

4. To increase or decrease the wavelength/frequency value defined in the **Set  $\lambda$ f** menu (see section *Specifying the Optical Emission Wavelength/Frequency*, p. 72) step by step, expand the **Step** menu and put the cursor before the **Step +** or **Step -** sub-menus and press the knob to step-adjust the value.

While the module is updating the wavelength/frequency, the message **Moving...** appears along with the new wavelength/frequency value after step-change.

5. Repeat step 4. until the wanted wavelength/frequency is reached.

## 8.5 Configuring the OSICS DFB Signal Modulation

**Presentation**

In addition to the OSICS Mainframe built-in modulation source (see section *Configuring the OSICS Mainframe Modulation*, p. 40), the OSICS DFB module holds a built-in digital modulation source.

The OSICS DFB module supports the following modulation schemes:

- Internal modulation:
  - Digital (TTL) modulation using the OSICS DFB internal source
  - Digital (TTL) modulation using the OSICS Mainframe internal source
- External modulation:
  - Digital (TTL) modulation using an external source connected to the OSICS Mainframe
  - Analog modulation using an external source connected to the OSICS DFB

The **OUT 2** BNC connector can be used as an external modulation source for other devices.

**Modulation Scheme**

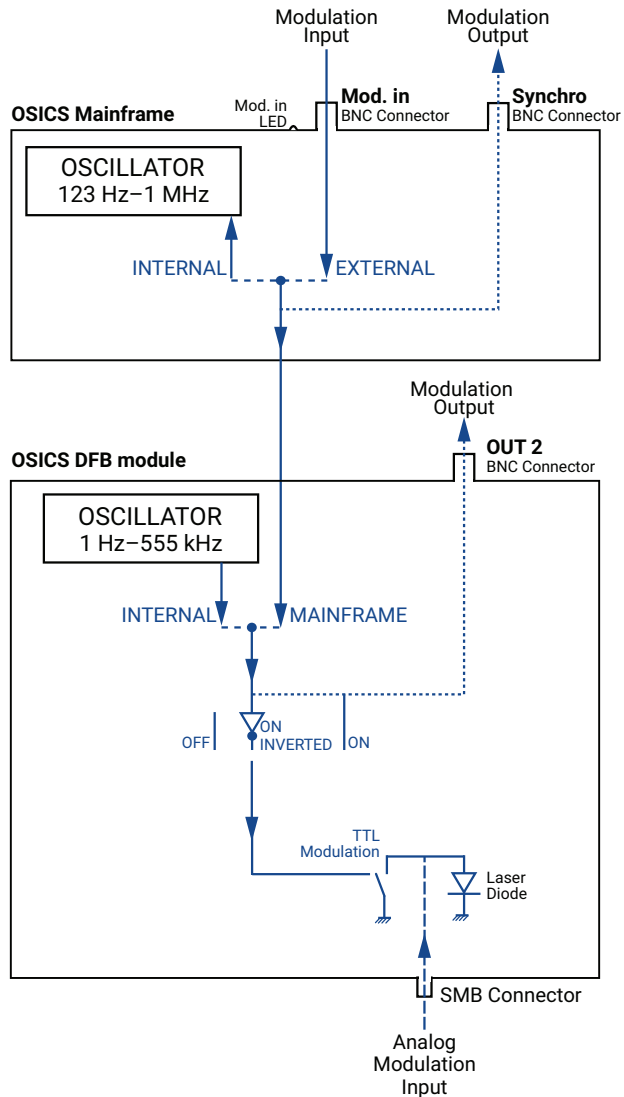

Figure 41: Mainframe and DFB Module Modulation Scheme

## 8.5.1 Setting Up Digital (TTL) Modulation Using the DFB Module Internal Source

### Subject

Digital modulation capabilities of the DFB module is within the 1 Hz–890 kHz frequency range (see the DFB specifications).

Internal digital modulation uses the DFB module's built-in TTL-level signal generator (see *Figure 41, p. 74*).

The DFB module's built-in TTL signal-generator can provide a TTL modulation signal in the range of 1 Hz–555 kHz.

The resulting modulated optical output signal follows a pattern as shown in the following figure.

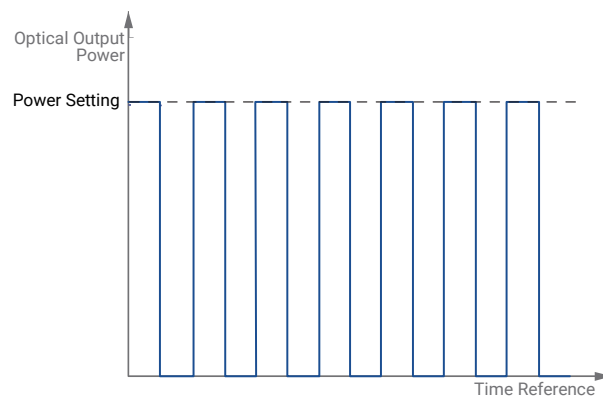

Figure 42: TTL-Modulated Output Power Signal (DFB Module)

### Procedure

#### Step 1 – Set the module modulation source to INTERNAL:

1. Access the DFB **Unit Setup** menu (see section *Accessing an OSICS Module Setup Menu, p. 33*).
2. Expand the **TTL Modulation** menu and enter the **Source** sub-menu.

The **Modulation source** sub-menu appears and the cursor automatically points to the current modulation source setting.

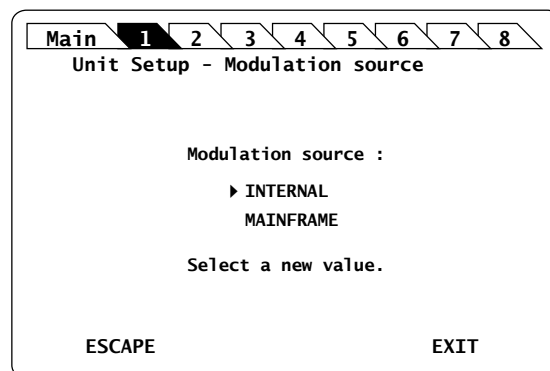

Figure 43: DFB Unit Setup – Modulation Source (Internal)

3. Turn the rotary knob to put the cursor before **INTERNAL** and press it to validate your selection.

The DFB **Unit Setup** menu is automatically displayed and the modulation is set to the selected source.

**Step 2 – Set the frequency of the module INTERNAL modulation source:**

1. In the DFB **Unit Setup** menu, expand the **TTL Modulation** menu and enter the **Set Frequency** sub-menu.

The **Set Frequency** sub-menu appears and displays the current selected modulation frequency.

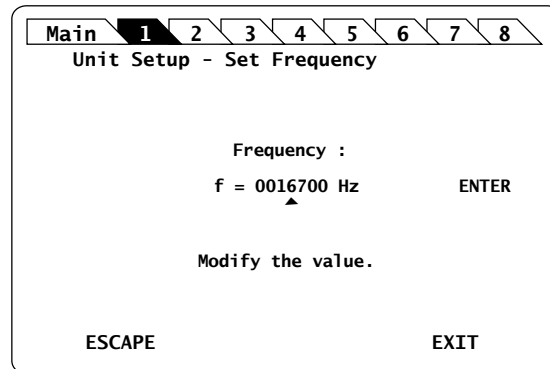

Figure 44: DFB Unit Setup – Set Frequency

2. Modify the frequency value as follows:
  - a. Turn the rotary knob to put the cursor under the digit you want to modify and press the knob to highlight it.
  - b. Turn the knob clockwise to increase the value or anticlockwise to decrease it and press the knob to validate the selected digit.
  - c. Perform steps 1. and 2. again with the other digits to modify.
  - d. Turn the rotary knob clockwise to put the cursor under **ENTER** and press the knob to validate the new frequency value.

The frequency is updated to the "real frequency". This screen displays the actual modulation frequency produced by the OSICS DFB oscillator, which may slightly differ from the values you have set.

3. Press the knob to validate the displayed real frequency.

**Step 3 – Set the modulation control:**

1. Access the DFB **Unit Setup** menu (see section *Accessing an OSICS Module Setup Menu*, p. 33).
2. Expand the **TTL Modulation** menu and enter the **Control** sub-menu.

The **Modulation control** sub-menu appears and displays the current state of the modulation control.

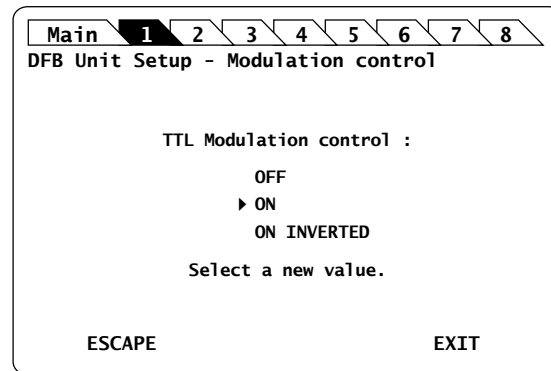

Figure 45: DFB Unit Setup – Modulation Control (On)

3. Turn the rotary knob to put the cursor before the wanted modulation:
  - **ON** for standard modulation.
  - **ON INVERTED** for reverse modulation
4. Press the rotary knob to validate your selection.

Modulation is enabled. In the **System Status** screen, the letter **M** is displayed in the channel **Info** field of the corresponding module.

5. To stop the modulation: in the **Control** sub-menu, select **OFF**.

## 8.5.2 Setting Up Digital (TTL) Modulation Using the Mainframe Internal Source

### Subject

This modulation setting uses the OSICS Mainframe's built-in internal oscillator as a source of TTL-level modulated signals (see *Figure 41*, p. 74). The main purpose of this setting is to provide simultaneous and synchronous modulation to several modules installed in the OSICS Mainframe, or to an external device connected to the OSICS Mainframe **Synchro** output connector.

The range of the frequency of the modulation provided by the OSICS Mainframe is defined to encompass the frequency requirements of all types of OSICS DFB modules. The frequency settings for the lower and upper bounds may therefore lie outside of the modulation capabilities of a particular module, in which case the module's own frequency range sets the modulation specifications.

The OSICS Mainframe signal generator can provide a TTL signal with a repetition frequency in the range 123 Hz–1 MHz.

The resulting signal-shape of the modulated output power is similar to the internally modulated pattern of the OSICS DFB, as shown in *Figure 42*, p. 75.

### Procedure

#### Step 1 – Set the OSICS Mainframe modulation source to INTERNAL:

1. Access the **Main Setup** menu (see section *Accessing the OSICS Mainframe Main Setup Menu*, p. 33).
2. Enter the **Source** sub-menu as follows:
  - a. Turn the rotary knob to put the cursor before the **Modulation** menu and press the knob to expand it.

- b. Turn the rotary knob to put the cursor before the **Source** sub-menu and press the knob to enter it.

The **Modulation Source** sub-menu appears and displays the current selected modulation source.

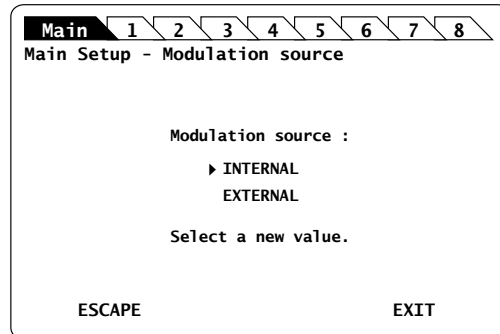

Figure 46: Main Setup – Modulation Source (Internal)

3. Turn the rotary knob to put the cursor before **INTERNAL** and press it to validate your selection.

The **Main Setup** menu is automatically displayed and the modulation is set to the selected source.

## Step 2 – Set the frequency of the OSICS Mainframe internal modulated-signal:

1. In the **Main Setup** menu, expand the **Modulation** menu and select the **Set frequency** sub-menu.

The **Modulation frequency** sub-menu appears and displays the current selected modulation frequency-value.

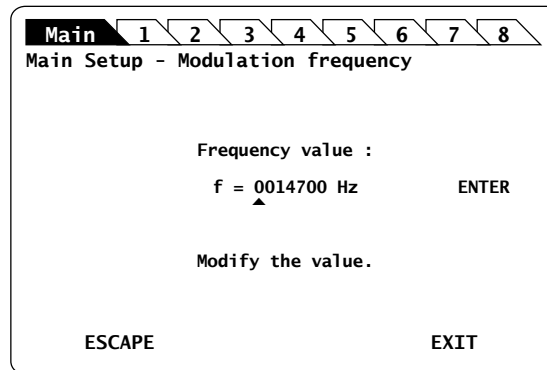

Figure 47: Main Setup – Modulation Frequency

2. Modify the frequency value as follows:

The internal TTL-signal generator can provide a TTL-modulated signal in the range 123 Hz to 1 MHz.

- a. Turn the rotary knob to put the cursor under the digit you want to modify and press the knob to highlight it.
- b. Turn the knob clockwise to increase the value or anticlockwise to decrease it and press the knob to validate the selected digit.
- c. Perform steps a. and b. again with the other digits to modify.
- d. Turn the rotary knob clockwise to put the cursor under **ENTER** and press the knob to validate the new frequency value.

The frequency is updated to the "real frequency" as shown in *Figure 48, p. 79*. This screen displays the current modulation frequency produced by the OSICS Mainframe oscillator, which may slightly differ from the values you have set.

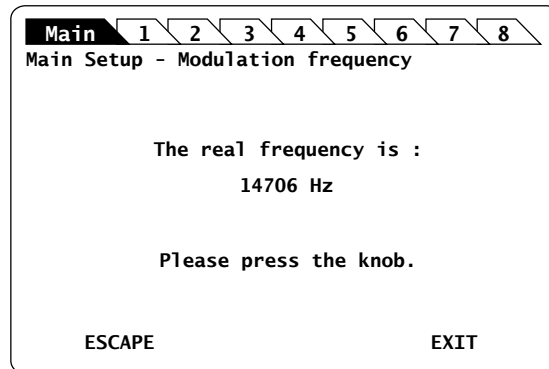

Figure 48: Main Setup – Modulation Real Frequency

3. Press the knob to go back to the **Main Setup** menu.

### Step 3 – Set the module modulation source to MAINFRAME:

1. Access the DFB **Unit Setup** menu (see section *Accessing an OSICS Module Setup Menu, p. 33*).
2. Expand the **TTL Modulation** menu and enter the **Source** sub-menu.

The **Modulation source** sub-menu appears and the cursor automatically points to the current modulation source setting.

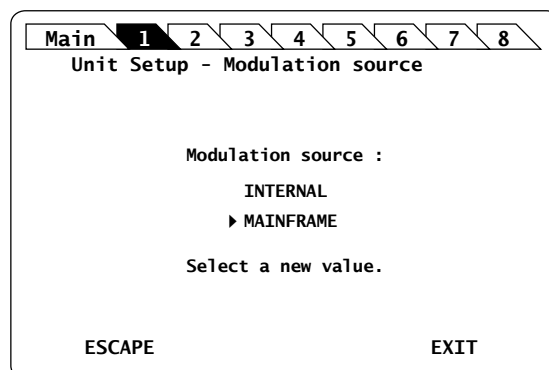

Figure 49: DFB Unit Setup – Modulation Source (Mainframe)

3. Turn the rotary knob to put the cursor before **MAINFRAME** and press it to validate your selection.

The DFB **Unit Setup** menu is automatically displayed and the modulation is set to the selected source.

### Step 4 – Set the modulation control:

1. Access the DFB **Unit Setup** menu (see section *Accessing an OSICS Module Setup Menu, p. 33*).
2. Expand the **TTL Modulation** menu and enter the **Control** sub-menu.

The **Modulation control** sub-menu appears and displays the current state of the modulation control.

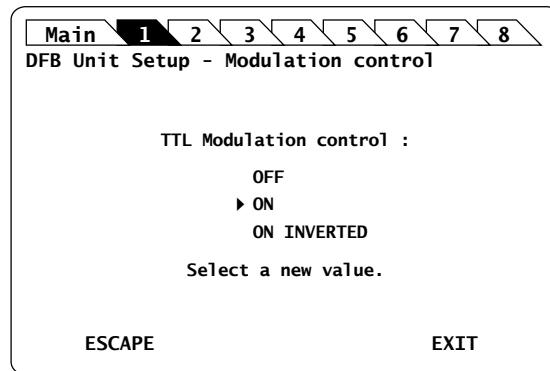

Figure 50: DFB Unit Setup – Modulation Control (On)

3. Turn the rotary knob to put the cursor before the wanted modulation:
  - **ON** for standard modulation.
  - **ON INVERTED** for reverse modulation
4. Press the rotary knob to validate your selection.

Modulation is enabled. In the **System Status** screen, the letter **M** is displayed in the channel **Info** field of the corresponding module.

5. To stop the modulation: in the **Control** sub-menu, select **OFF**.

### 8.5.3 Setting Up Digital (TTL) Modulation Using an External Source

#### Subject

External digital-modulation is achieved by applying a digital signal to the BNC **Mod. In** connector located on the OSICS Mainframe rear panel (see *Figure 41, p. 74*). This allows all the modules (or an external device connected to the OSICS Mainframe **Synchro** output connector) to be modulated in a synchronous way by means of an external source. The OSICS Mainframe distributes the external modulated-signal to all installed modules in order to synchronize all modules with a single modulated signal, amplitude, and frequency.

For optimum stability of the modulated signals, we recommend applying a digital modulation in the specified range of the modules.

#### Before Starting

Make sure you have a digital-signal generator.

#### Procedure

##### Step 1 – Set the OSICS Mainframe modulation source to EXTERNAL:

1. Access the **Main Setup** menu (see section *Accessing the OSICS Mainframe Main Setup Menu, p. 33*).
2. Enter the **Source** sub-menu as follows:
  - a. Turn the rotary knob to put the cursor before the **Modulation** menu and press the knob to expand it.
  - b. Turn the rotary knob to put the cursor before the **Source** sub-menu and press the knob to enter it.

The **Modulation source** sub-menu appears and displays the current selected modulation source.



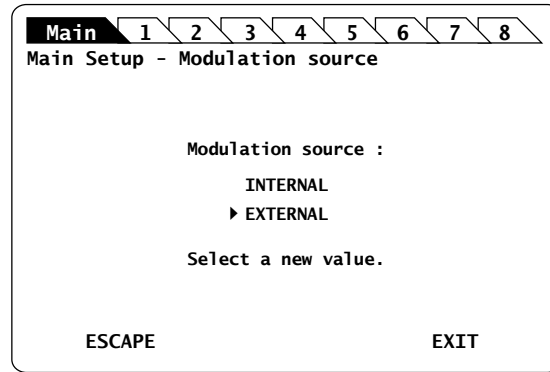

Figure 51: Main Setup – Modulation Source (External)

- Turn the rotary knob to put the cursor before **EXTERNAL** and press it to validate your selection.

The **Main Setup** menu is automatically displayed and the modulation is set to the selected source.

### Step 2 – Set the TTL-level signal generator:

- On the OSICS Mainframe rear panel, connect your external digital signal-generator to the **Mod. in** BNC connector (see *Figure 2, p. 18*).
- Apply the TTL signal not exceeding the maximum voltage of +5 V and repetition frequency between 1 Hz and 890 kHz.

The green LED located next to the **Mod. In** connector is lit to indicate that an external signal-generator is connected.

### Step 3 – Set the module modulation source to MAINFRAME:

- Access the DFB **Unit Setup** menu (see section *Accessing an OSICS Module Setup Menu, p. 33*).
- Expand the **TTL Modulation** menu and enter the **Source** sub-menu.

The **Modulation source** sub-menu appears and the cursor automatically points to the current modulation source setting.

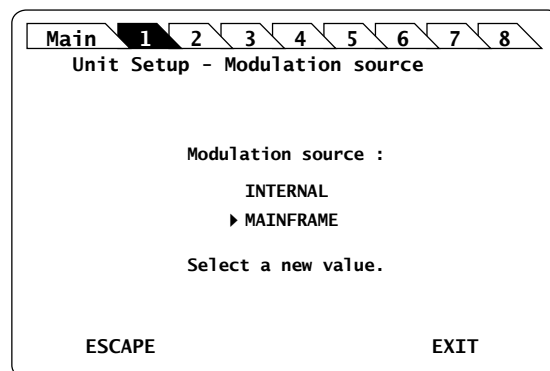

Figure 52: DFB Unit Setup – Modulation Source (Mainframe)

- Turn the rotary knob to put the cursor before **MAINFRAME** and press it to validate your selection.

The DFB **Unit Setup** menu is automatically displayed and the modulation is set to the selected source.

**Step 4 – Set the modulation control:**

1. Access the DFB **Unit Setup** menu (see section *Accessing an OSICS Module Setup Menu*, p. 33).
2. Expand the **TTL Modulation** menu and enter the **Control** sub-menu.

The **Modulation control** sub-menu appears and displays the current state of the modulation control.

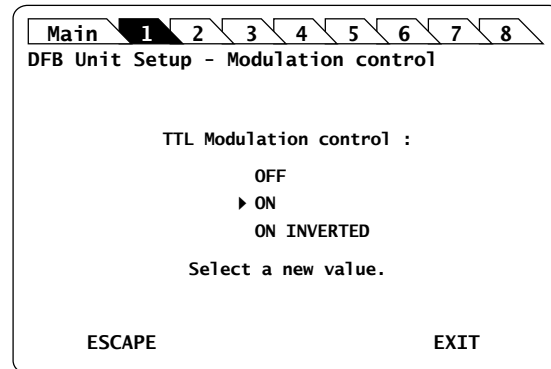

Figure 53: DFB Unit Setup – Modulation Control (On)

3. Turn the rotary knob to put the cursor before the wanted modulation:
  - **ON** for standard modulation.
  - **ON INVERTED** for reverse modulation
4. Press the rotary knob to validate your selection.
 

Modulation is enabled. In the **System Status** screen, the letter **M** is displayed in the channel **Info** field of the corresponding module.
5. To stop the modulation: in the **Control** sub-menu, select **OFF**.

## 8.5.4 Setting Up Analog Modulation Using an External Source

### Subject

The SMB connector located on the front panel of the DFB module is directly connected to the laser chip and allows you to couple an external modulating-current to the system bias current (see *Figure 41, p. 74*).

By modulating this external current, you can modulate the optical power output in a frequency range from 150 Hz to 150 MHz.

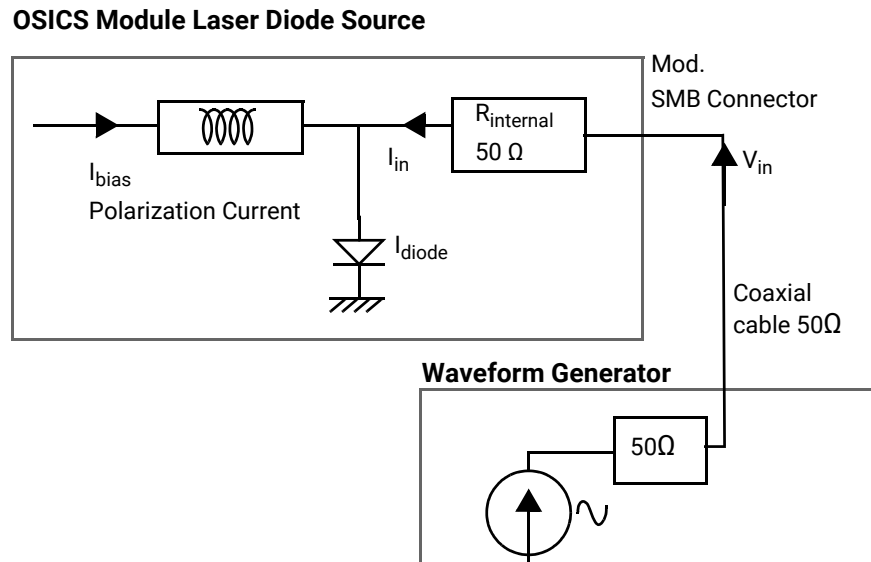

Figure 54: External Analog Modulation Setup

The relationship between the voltage applied at the SMB input and the current added to the diode is given by:  $I_{in} = V_{in}/R_{internal}$

where:

- $I_{in}$  is the added current
- $V_{in}$  is the voltage applied to the SMB input
- $R_{internal}$  is the 50  $\Omega$  internal impedance of your DFB module

TTL modulation can also be applied directly on the module's front panel using the input SMB connector generally used for the analog modulation. The modulation is applied directly on the laser chip. In this case, simultaneous modulation for all the modules is not possible.

Laser diode current level is available in section *OSICS DFB Technical Specifications, p. 65*.

### Before Starting

Make sure you have a 50  $\Omega$  coaxial cable to connect your HF-generator to the 50  $\Omega$  input SMB connector.



#### Caution

Before applying an external analog-modulation, make sure the modulation control is set to off.

### Procedure

1. Set the module modulation control to off as follows:

- a. Access the DFB **Unit Setup** menu (see section *Accessing an OSICS Module Setup Menu*, p. 33).
- b. Expand the **TTL Modulation** menu and enter the **Control** sub-menu.

The **Modulation control** sub-menu appears and displays the current state of the modulation control.

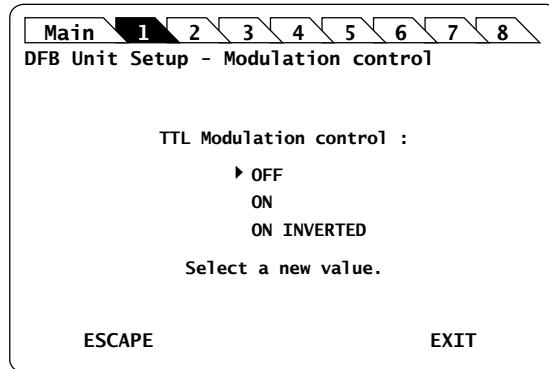

Figure 55: DFB Unit Setup – Modulation Control (Off)

- c. Turn the rotary knob to put the cursor before **OFF** and press it to validate your selection.

Modulation control is disabled and the DFB **Unit Setup** menu is displayed.

2. Connect your HF-generator to the 50 Ω input SMB connector using a 50 Ω coaxial cable.



#### Caution

The SMB input is directly connected to the laser diode chip via a 50 Ω resistor. It is essential to make sure that at all times the diode is forward-biased to avoid damage or possible destruction of the diode.

3. Since the SMB input is directly connected to the laser diode chip, make sure that the input voltage is such that the following conditions are always met:
  - The diode laser is forward-biased.
  - The current flowing through the diode is lower than the maximum allowed current ( $I_{max}$ ) indicated in the system acceptance test report.

The best way to fulfill the above conditions is to monitor the DFB module bias-current ( $I_{bias}$ ) via the rated output voltage measured at the **OUT 1** port located on the rear panel of the OSICS Mainframe (see *Figure 2*, p. 18), and to compute the total current using the following formula:

$$I_{diode} = I_{bias} + V_{in}/R_{internal}$$

Where:

- $I_{diode}$  is the total current through the diode
- $I_{bias}$  is the bias current
- $V_{in}$  is the voltage applied to the SMB input
- $R_{internal}$  is the 50 Ω internal impedance of the DFB module

You must monitor  $V_{in}$  to ensure that the total current remains positive and lower than the maximum allowed current ( $I_{max}$ ), as shown in the following figure:

$$0 < I_{diode} < I_{max}$$

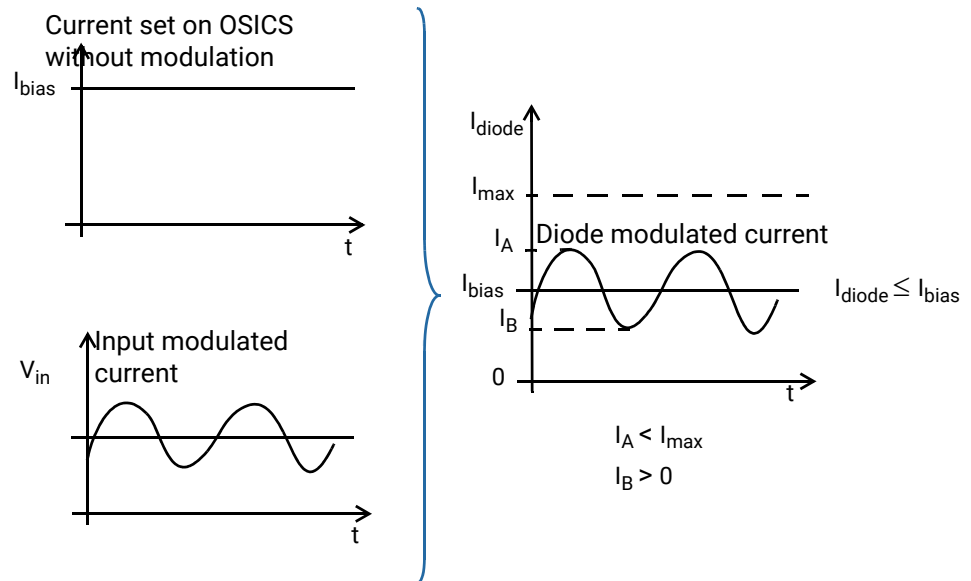

Figure 56: Resulting Diode Current with External Analog Modulation Source

If the voltage applied to the SMB input is an AC signal with no DC component and with peak-to-peak amplitude is  $V_{pp}$ , the above condition becomes:

$$V_{pp} < 2 \times R_{\text{internal}} (I_{\text{max}} - I_{\text{bias}})$$

$$V_{pp} < 2 \times R_{\text{internal}} (I_{\text{bias}})$$

## 8.5.5 Setting Up Analog Modulation With the Internal Sinus Modulation

### Subject

Sinus Modulation is an internal modulation feature implemented on the DFB module and designed to limit the effect of Brillouin scattering.

The DFB module can generate a sinusoidal signal with a user-defined frequency in the range of 10 kHz–100 kHz and a user-defined modulation-rate in the range of 0%–15% (of the diode current value) to modulate the current of the diode.

The following figure shows the resulting sinusoidal modulation of the laser diode bias-current for a given modulation rate (< 15%) and frequency. The new diode current fluctuates symmetrically around the original value of the bias-current ( $I_{\text{bias}}$ ).

$I_{\text{bias}}$  is the mean average of the new modulated current.

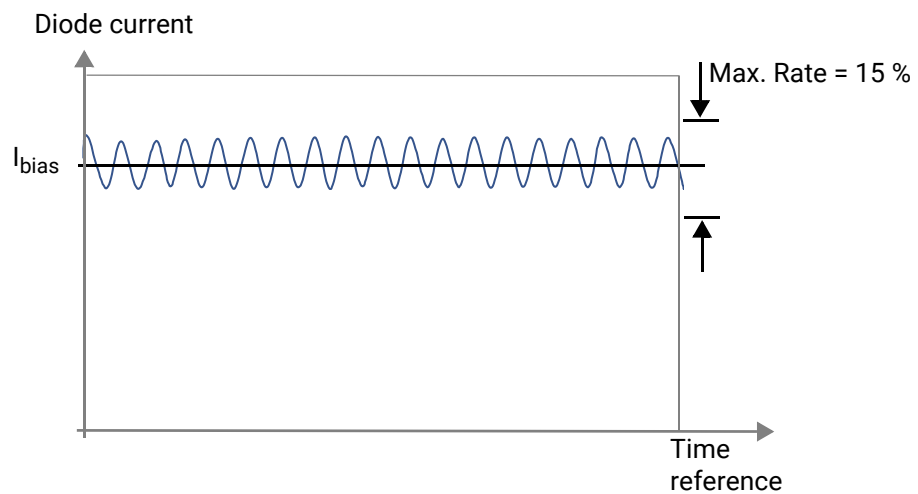

Figure 57: Diode current resulting from sinusoidal modulation

### 8.5.5.1 Specifying the Sinus Frequency

#### Subject

To use the Sinus frequency, you must first set the internal frequency (in the range 10 kHz–100 kHz). The frequency unit cannot be modified; it is defined in kHz.

#### Procedure

1. Access the **DFB Unit Setup** menu (see section *Accessing an OSICS Module Setup Menu*, p. 33).
2. Expand the **Sinus Modulation** menu and enter the **Set Frequency** sub-menu.

The **Set Sinus Frequency** sub-menu appears and displays the current frequency of the sinus modulation signal.

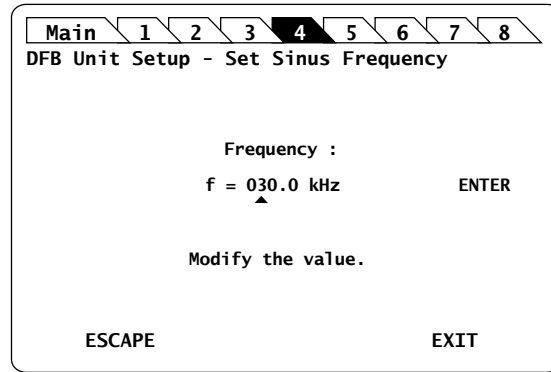

Figure 58: DFB Unit Setup – Sinus Modulation (Set Frequency)

3. Modify the frequency value as follows:

A valid sinusoidal frequency value may range from 10 kHz to 100 kHz.

- a. Turn the rotary knob to put the cursor under the digit you want to modify and press the knob to highlight it.
- b. Turn the knob clockwise to increase the value or anticlockwise to decrease it and press the knob to validate the selected digit.
- c. Perform steps 1. and 2. again with the other digits to modify.
- d. Turn the rotary knob clockwise to put the cursor under **ENTER** and press the knob to validate the new frequency value.

The sinus frequency is updated.

### 8.5.5.2 Specifying the Sinus Rate

**Subject** The sinus rate is defined as the amplitude of the sinusoidal modulating-signal. This rate value allows to calculate the amplitude of the modulation as a direct percentage of the diode bias-current ( $I_{\text{bias}}$ ). The rate can range from 0% to 15% of the diode bias-current. Setting this rate value to 15% means that the resulting diode current is modulated  $\pm 15\%$  around the mean average ( $I_{\text{bias}}$ ).

**Procedure**

1. Access the DFB **Unit Setup** menu (see section *Accessing an OSICS Module Setup Menu, p. 33*).
2. Expand the **Sinus Modulation** menu and enter the **Set Rate** sub-menu.  
The **Set Sinus Rate** sub-menu appears and displays the current rate of the sinusoidal modulation signal.

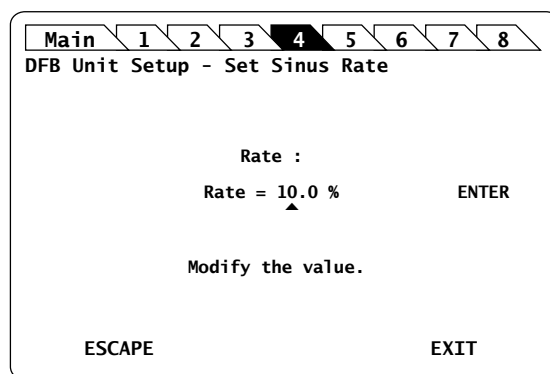

Figure 59: DFB Unit Setup – Sinus Modulation (Set Rate)

3. Modify the rate value as follows:
 

A valid sinus rate value may range from 5 % to 15 %.

  - a. Turn the rotary knob to put the cursor under the digit you want to modify and press the knob to highlight it.
  - b. Turn the knob clockwise to increase the value or anticlockwise to decrease the value and press the knob to validate the selected digit.
  - c. Perform steps 1. and 2. again with the other digits to modify.
  - d. Turn the rotary knob clockwise to put the cursor under **ENTER** and press the knob to validate the new rate value.

The sinus rate is updated.



### 8.5.5.3 Turning on/off the Sinus Modulation

**Subject** This section explains how to switch on and off the sinus modulation.

**Before Starting** Make sure the internal frequency and modulation rate are set (see section *Specifying the Sinus Frequency*, p. 86 and section *Specifying the Sinus Rate*, p. 88).

**Procedure**

1. Access the **DFB Unit Setup** menu (see section *Accessing an OSICS Module Setup Menu*, p. 33).
2. Expand the **Sinus Modulation** menu and enter the **Control** sub-menu.  
The **Modulation Control** sub-menu appears and displays the current state of the modulation function.

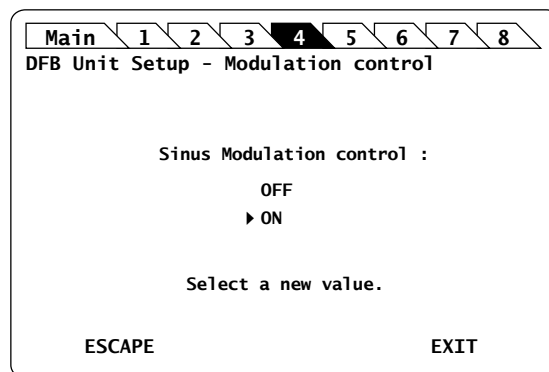

Figure 60: DFB Unit Setup – Sinus Modulation Control

3. Turn the rotary knob to put the cursor before the **ON** setting:
4. Press the rotary knob to validate your selection.

The sinus modulation is implemented immediately.

In the **System Status** screen, the message **S** appears in front of the corresponding module channel.

5. To stop the modulation: in the **Control** sub-menu, select **OFF**.

## 8.5.6 Using the DFB Module as a Modulation Source for External Devices (OUT 2 Output)

### Subject

The OSICS Mainframe rear panel (see *Figure 2, p. 18*) features eight channel ports, each dedicated to a specific channel-slot and identified by its channel number (CH1 to CH8). As they are numbered from left to right, channel ports do not face across their corresponding slots.

Each channel can produce two types of output signals on BNC connectors:

- **OUT 1:** analog signal for constant monitoring of the laser diode current, output power or laser chip temperature. For more details, see section *Monitoring the OSICS DFB Module Parameters Using the Analog OUT 1 Output, p. 91*.
- **OUT 2:** analog signal from the DFB module (see *Figure 41, p. 74*) that you can use as an external modulation source for other devices. The following procedure explains how to set the OUT 2 analog signal.

You can also use the OSICS Mainframe as a modulation source for external devices with the **Synchro** BNC output connector, as explained in section *Using the Mainframe as a Modulation Source for External Devices (Synchro Output), p. 44*.

### Procedure

1. Set up the wanted digital modulation to the DFB module using one of the following methods:
  - DFB module internal modulation source, as explained in section *Setting Up Digital (TTL) Modulation Using the DFB Module Internal Source, p. 75*.
  - OSICS Mainframe internal modulation source, as explained in section *Setting Up Digital (TTL) Modulation Using the Mainframe Internal Source, p. 77*.
  - OSICS Mainframe external modulation source, as explained in section *Setting Up Digital (TTL) Modulation Using an External Source, p. 80*.
2. Connect the wanted appropriate device to the **OUT 2** BNC connector corresponding to the channel slot number of the module.

The selected modulation frequency is applied to the connected device.

## 8.6 Monitoring the OSICS DFB Module Parameters Using the Analog OUT 1 Output

**Subject** The OSICS Mainframe rear panel (see *Figure 2, p. 18*) features eight channel ports, each of them is dedicated to a specific channel-slot and identified by its channel number (CH1 to CH8).

As they are numbered from left to right, channel ports do not face across their corresponding slots.

Each channel can produce two types of output signals on BNC connectors:

- **OUT 2:** analog signal from the DFB module that you can use as an external modulation source for other devices. For more details, see section *Using the DFB Module as a Modulation Source for External Devices (OUT 2 Output)*, p. 90.
- **OUT 1:** analog signal for constant monitoring of the DFB laser diode current ( $I_{LD}$ ), output power ( $P_{OUT}$ ), or laser chip temperature ( $\theta$ ).

The scale-factors for the OUT 1 signal are the following (FPGA v.6.00):

- Laser diode current ( $I_{LD}$ ): 10 V / 300 mA
- Optical output power ( $P_{OUT}$ ): 10 V / 30 mW
- Laser chip temperature ( $\theta$ ): 0 V = 10°C; 10 V = 45°C

The following procedure explains how to set the OUT 1 analog signal.

**Before Starting** Make sure you have an oscilloscope.

- Procedure**
1. Access the DFB **Unit Setup** menu (see section *Accessing an OSICS Module Setup Menu*, p. 33).
  2. Turn the rotary knob to put the cursor before the **Analog out** menu and press the knob.

The **Analog Out** menu appears and displays the monitoring signal currently active on the OUT1 connector.

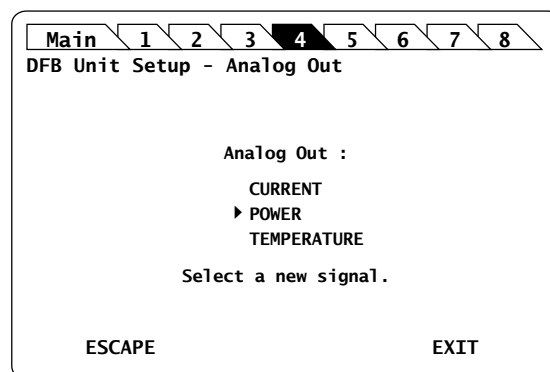

Figure 61: DFB Unit Setup – Analog Out setting

3. Turn the rotary knob to put the cursor before the parameter you want to monitor and press it to validate your selection.

The selected parameter is validated and the DFB **Unit Setup** menu is displayed.

4. To monitor the selected signal, connect your oscilloscope to the **OUT 1** BNC connector corresponding to the channel slot number of the module.

## 8.7 Calibrating the DFB Module

### 8.7.1 Performing a Wavelength Calibration

**Subject** The **Wavelength Calibration** function enables you to apply a wavelength offset to the DFB emission wavelength. The value entered as wavelength offset is a "d" offset between the calibrated wavelength and the wavelength announced by the DFB display.

You can use the wavelength offset in either of two ways:

- To apply an arbitrary offset to the displayed wavelength, as required by your particular application.
- To apply a calibration offset computed as the difference between the wavelength reading on the wavemeter and the value displayed by the DFB module.

The wavelength offset applies on the DFB tuning mechanism and changes the value of the actual emission wavelength. The wavelength value displayed by the DFB is unchanged.

For example, if the wavelength setting of the DFB module is 1560.000 nm, and you set an offset of +0.100 nm, the actual emission wavelength at the optical output is offset +0.100 nm but the DFB display is unchanged and still shows 1560.000 nm.

You can set a wavelength offset from -0.200 nm to +0.200 nm.

**Before Starting** Enable the optical output of the module (see section *Enabling/Disabling the Light Source of the Module*, p. 69).

**Procedure** 1. Access the DFB **Unit Setup** menu (see section *Accessing an OSICS Module Setup Menu*, p. 33).

2. Expand the **Calibration** menu and enter the **Wavelength calibration** sub-menu.

The **Wavelength calibration** sub-menu appears prompting you to enter the wavelength offset in nm.

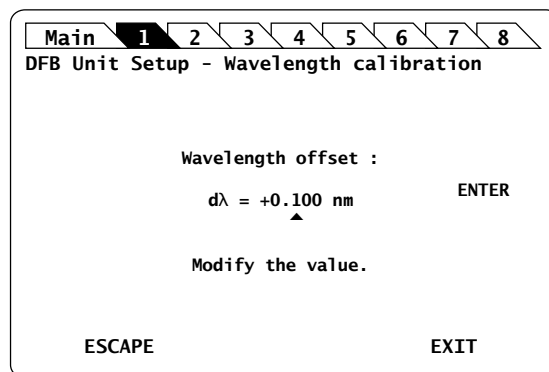

Figure 62: DFB Unit Setup – Wavelength calibration

3. Modify the wavelength value as follows:

A valid wavelength offset value can range from -0.200 nm to +0.200 nm.

- Turn the rotary knob to put the cursor under the digit you want to modify and press the knob to highlight it.
- Turn the knob clockwise to increase the value or anticlockwise to decrease the value and press the knob to validate the selected digit.

- c. Perform steps a. and b. again with the other digits to modify.
- d. Turn the rotary knob clockwise to put the cursor under ENTER and press the knob to validate the value.

A confirmation message is displayed

4. Press the knob to confirm.

The message `Calibrating...` is displayed during the calibration process. It may take up to two minutes.

Once the calibration is performed, the **Unit Setup** menu is displayed.

## 8.7.2 Performing a Power Calibration

**Subject** This section explains how to perform a one-point power calibration sequence using the **Power calibration** function. The purpose of this calibration is to correct the discrepancies between the power displayed by the OSICS DFB module and the power measured at your reference power meter. The new calibration data sets the new system calibration default.

**Before Starting** Make sure you have a power meter.

**Procedure**

1. Set the DFB output power to **1 mW**.
2. Connect the optical output of the OSICS DFB module to a power meter.
3. Enable the module optical output (see section *Enabling/Disabling the Light Source of the Module*, p. 69).
4. Access the DFB **Unit Setup** menu (see section *Accessing an OSICS Module Setup Menu*, p. 33).
5. Expand the **Calibration** menu and enter the **Power calibration** sub-menu.

The message `Moving...` appears, and the **Power calibration** sub-menu appears, prompting you to correct the power value.

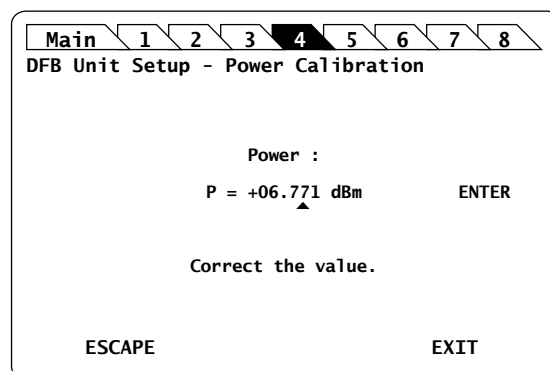

Figure 63: DFB Unit Setup – Power calibration

6. Measure the power level on the power meter.  
A valid power value can range from 0.6 mW to 1.2 mW.
7. Enter the power value measured by the power meter and select **ENTER**.  
The message `Moving...` appears while the power value is set. A confirmation message appears.

8. Press the knob to confirm.

The message `Moving . . .` appears while the power value is set. The power calibration is now complete and the values are stored in the module's non-volatile memory.

The DFB **Unit Setup** menu is displayed.

The new calibration data sets the new system calibration default.

### 8.7.3 Asking for a Factory Recalibration

#### Subject

To externally verify the performance of the OSICS, refer to the procedure described in section *Performing a Wavelength Calibration*, p. 92 and section *Performing a Power Calibration*, p. 93. If the performance does not meet warranted specifications, a complete calibration of the instrument may be required.

We recommend performing factory calibration of OSICS DFB modules over one-year intervals.

#### Procedure

Contact the EXFO customer support service (see section *Contact Information*, p. 4) for a complete calibration, as some calibration steps require the adjustment of internal components including the laser head.

## 8.8 Testing the Performance of the DFB Module

Use the procedures described in this section to validate warranted specifications of the OSICS DFB module, as needed.

During the performance verification, the settings for wavelength and power may not agree with the measured values. If this occurs, you may calibrate wavelength and power settings as explained in section *Performing a Wavelength Calibration*, p. 92 and section *Performing a Power Calibration*, p. 93.

Notwithstanding performance tests described in this section, we recommend performing calibration of OSICS DFB modules over one-year intervals (see section *Asking for a Factory Recalibration*, p. 94).

### 8.8.1 Preparing Performance Tests

#### Before Starting

Make sure you have the following required equipment for conducting performance tests on OSICS DFB modules:

Equipment	Minimum Requirement
Optical power meter	Wavelength range: 1260 nm to 1640 nm
Optical spectrum analyzer (OSA)	Wavelength range: 1260 nm to 1640 nm
Wavemeter	Wavelength range: 1260 nm to 1640 nm
Jumper (x2)	FC/APC to FC/PC or to FC/APC
In-line optical adapter	FC to FC

The various types as well as the number of fiber-optic connectors needed may vary depending on the type of equipment used and the distance between the test equipment and the OSICS DFB modular optical source under test.



#### Warning

- Disable the laser output before connecting or disconnecting a fiber optic cable on the module (see section *Enabling/Disabling the Light Source of All Modules*, p. 37).
- Do not look directly into the fiber end of an optical cable connected to any optical output while the device is in use. This may cause permanent eye damage.

#### Procedure

1. In the OSICS Mainframe, install the DFB modules you want to test.
2. Turn-on the OSICS multifunction platform (see section *Turning on the OSICS Multifunction Platform and Accessing the System Status Screen*, p. 29).
3. Let the OSICS multifunction platform and other test equipments run continuously for 2 hours at room temperature (within the specified operating temperature range) to achieve proper equipment warm-up.

## 8.8.2 Measuring the Absolute Wavelength Accuracy

<b>Subject</b>	This test procedure enables you to verify that the actual measured wavelength stays within acceptable deviation range from the wavelength setting.
<b>Before Starting</b>	<ul style="list-style-type: none"> <li>• Make sure you have a wavemeter with <math>\pm 1</math> pm resolution and a NIST-traceable calibration (see section <i>Preparing Performance Tests</i>, p. 95) and jumper.</li> </ul>
<b>Procedure</b>	<ol style="list-style-type: none"> <li>1. Connect the OSICS DFB module to the wavemeter.</li> <li>2. Set the OSICS DFB output power to maximum (the value of the maximum output depends on your DFB model).</li> <li>3. Set the wavelength of the OSICS DFB tunable laser to the minimum value of the wavelength range. The minimum wavelength depends on the DFB model you are using (see section <i>Specifying the Optical Emission Wavelength/Frequency</i>, p. 72).</li> <li>4. Set the wavelength step to +0.1 nm.</li> <li>5. Enable the laser output by pressing the <b>Enable</b> button on the module front panel.</li> <li>6. Compute the wavelength deviation of the DFB module and check that it is not greater than <math>\pm 0.03</math> nm compared with the wavelength reading of the wavemeter.  The absolute wavelength accuracy is the deviation between the wavelength setting and the wavelength reading provided by the wavemeter at each measurement step.</li> <li>7. Increment the DFB wavelength setting one wavelength step (+0.1 nm) and repeat measurement step 6. to check that the wavelength deviation is not greater than <math>\pm 0.03</math> nm.</li> <li>8. Stop when you reach the DFB maximum wavelength limit.  If the minimum and maximum wavelength limits do not meet the specifications, you can calibrate these values as explained in section <i>Performing a Wavelength Calibration</i>, p. 92.</li> </ol>

## 8.8.3 Verifying the Wavelength Stability

<b>Subject</b>	This procedure enables you to verify the DFB module wavelength stability in the long-term run, typically over 1-hour continuous use.
<b>Before Starting</b>	Make sure you have an appropriate wavemeter (see section <i>Preparing Performance Tests</i> , p. 95) and jumper.
<b>Procedure</b>	<ol style="list-style-type: none"> <li>1. Disable the DFB laser output.</li> <li>2. Connect the OSICS DFB module to the wavemeter.</li> <li>3. Set the OSICS DFB output power to maximum (the value of the maximum output depends on your DFB model, see section <i>OSICS DFB Technical Specifications</i>, p. 65).</li> <li>4. Set the wavelength of the OSICS DFB laser to the center wavelength (the value of the center wavelength depends on your DFB model, see section <i>OSICS DFB Technical Specifications</i>, p. 65).</li> <li>5. Enable the laser output by pressing the <b>Enable</b> button on the DFB front panel.</li> </ol>



6. Record the wavelength reading on the wavemeter every 30 seconds during 1 hour.
7. After one-hour sampling:
  - a. Pick the maximum and the minimum wavelength values from the wavelength records.
  - b. Subtract the minimum wavelength value from the maximum recorded wavelength value to get the wavelength stability.
  - c. Verify that the calculated wavelength stability value is within the specification range of  $\pm 0.005$  nm/h.

## 8.8.4 Verifying the Power Stability

<b>Subject</b>	This procedure enables you to verify if the DFB module power stability is within specifications in the long-term run, typically over 1-hour continuous use.
<b>Before Starting</b>	Make sure you have an appropriate power-meter (see section <i>Preparing Performance Tests</i> , p. 95) and jumper.
<b>Procedure</b>	<ol style="list-style-type: none"> <li>1. Disable the DFB laser output.</li> <li>2. Connect the OSICS DFB module to the power-meter.</li> <li>3. Set the OSICS DFB output power to maximum (the value of the maximum output depends on your DFB model, see section <i>OSICS DFB Technical Specifications</i>, p. 65).</li> <li>4. Set the wavelength of the OSICS DFB laser to the center wavelength (the value of the center wavelength depends on your DFB model, see section <i>OSICS DFB Technical Specifications</i>, p. 65).</li> <li>5. Enable the laser output by pressing the <b>Enable</b> button on the DFB front panel.</li> <li>6. Record the wavelength reading on the power-meter every 30 seconds during 1 hour.</li> <li>7. After one-hour sampling:           <ol style="list-style-type: none"> <li>a. Pick the maximum and the minimum power values from the wavelength records.</li> <li>b. Subtract the minimum power value from the maximum recorded power value to get the power stability.</li> <li>c. Verify that the calculated wavelength stability value is within the specification range of <math>\pm 0.01</math> db/h.</li> </ol> </li> </ol>



## 9. Using the OSICS SLD Module

This section explains how to operate the OSICS SLD via the SLD **Unit Setup** menu. For more details on how to install and initialize the module into the OSICS Mainframe, see section *Installing and Connecting the OSICS Multifunction Platform*, p. 21.

### 9.1 OSICS SLD Presentation

The OSICS SLD is a broadband light source rack module designed for fiber-optic component and system testing, based on superluminescent light emitting diode.

#### 9.1.1 OSICS SLD Technical Specifications

		OSICS SLD 1300	OSICS SLD 1550
Central Wavelength <sup>*1*2</sup>		1320 nm	1540 nm
Spectral Width <sup>*3</sup>	-3 dB (FWHM)	50 nm	
	-10 dB	80 nm	
	-20 dB	100 nm	
	-30 dB	125 nm	
Total Output Power	High	+10 mW	
	Low	+5 mW	
Power Stability Over Temperature Range		±0.1 dB	
Power Stability at Constant Temperature		±0.01 dB	
Optical Fiber		SMF	
Optical Interface		FC/APC connector	

\*1: Typical.

\*2: ±20 nm.

\*3: Guaranteed at output power = 5 mW.

## 9.1.2 OSICS SLD Module Overview

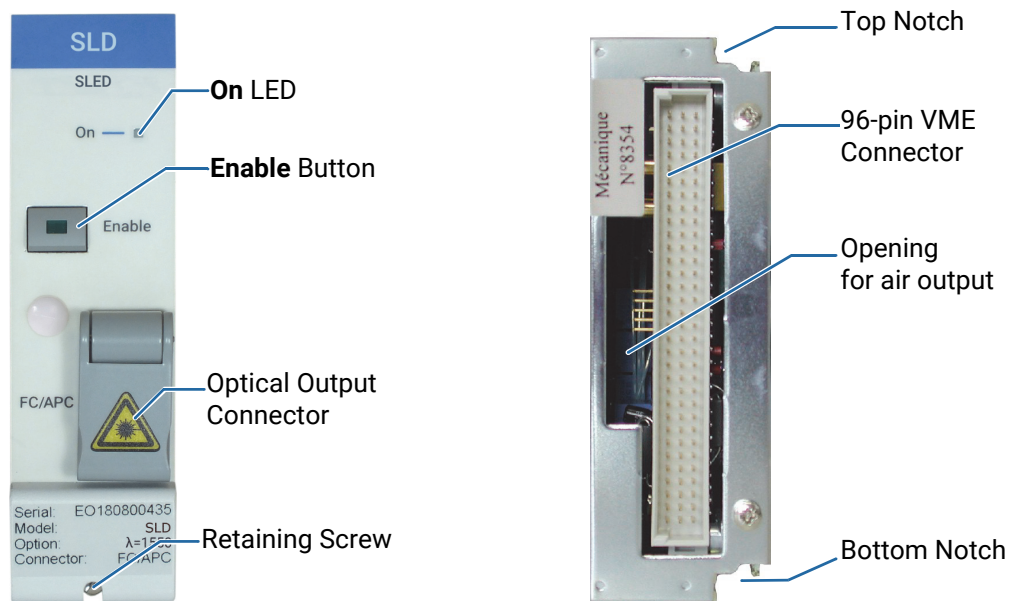

Figure 64: SLD Module – Front and Rear Panels

### Front Panel

#### On LED

This LED indicates that the module is turned on (see section *Turning on the OSICS Multifunction Platform and Accessing the System Status Screen*, p. 29).

#### Enable Button

This button enables you to turn on/off the optical output of the module. The green LED of the button is lit if the optical output is enabled, and the power value is displayed in the System Status screen (see section *System Status Screen Description*, p. 30).

#### Optical Output Connector

The standard output connector is a FC/APC type connector.

For more details on the appropriate fiber type, see section *OSICS SLD Technical Specifications*, p. 99.

The  label located on the optical output connector cap indicates the location of the laser source.



#### Warning

Do not look directly into the fiber end of an optical cable connected to any optical output while the device is in use. This may cause permanent eye damage.

### Retaining Screw

The captive screw enables you to lock/unlock the module inserted into the slot of the OSICS Mainframe.



#### Caution

The OSICS Mainframe does not support "hot-swap" of modules; for more details, see section *Handling OSICS Modules Into the OSICS Mainframe*, p. 23).

## Rear Panel

### Notches

The top and bottom notches enable you to slide the module into the OSICS Mainframe slot (see section *Installing an OSICS Module Into the OSICS Mainframe*, p. 23).

### 96-pin VME Connector

The rear panel of the OSICS modules interfaces with the OSICS Mainframe backplane by means of the 96-pin VME connector.

### Opening

The opening ensures proper flow of cooled air drawn from the OSICS Mainframe chassis.

## Side Panel

The labels affixed on the side panel of the OSICS SLD are described in section *OSICS Information and Warning Markings*, p. 19.

## 9.2 Enabling/Disabling the Light Source of the Module

### Subject

You can enable/disable the light source in two different ways:

- From the OSICS Mainframe **Main Setup** menu (see section *Enabling/Disabling the Light Source of All Modules, p. 37*), you can simultaneously enable or disable the light source in all the modules installed in the OSICS Mainframe. This function overrides the enable/disable state individually set in all modules.
- From the SLD front panel, you can individually enable or disable the light source of the module by using the **Enable** button as explained in the following procedure. This action does not affect the enable/disable state of other modules installed in the OSICS Mainframe.

For laser safety reasons, the light source in modules are disabled after OSICS initialization.

### Before Starting

Connect an optical device to the OSICS module (see section *Connecting Optical Devices to OSICS Modules, p. 26*).



#### Warning

- Do not enable the laser while there is no fiber connected to the optical output connector.
- Do not look directly into the fiber end of an optical cable connected to any optical output while the device is in use. This may cause permanent eye damage.

### Procedures

#### Enabling the Light Source of the Module

- On the SLD module front panel press the **Enable** button.

The green LED on the button is lit.

In the **System Status** screen, the output power is displayed in the **P** field (in dBm or mW depending on the selected power unit) for the corresponding module.

#### Disabling the Light Source of the Module

- On the SLD module front panel press the **Enable** button.

The green LED on the button is turned off.

In the **System Status** screen, the message **Disabled** is displayed for the corresponding module.

## 9.3 Setting the Optical Output Power of the SLD Module

- Subject** You can set the optical output power in two different ways:
- From the OSICS Mainframe **Main Setup** menu, you can simultaneously set the optical power of all modules to the same value: see section *Setting the Optical Output Power of All Installed Modules*, p. 38.
  - From the SLD **Unit Setup** menu, you can set the output power of the module individually as explained in the following procedure.

The power value is software-limited to stay within the specified range.

- Before Starting**
- Set the optical power unit from the OSICS Mainframe **Main Setup** menu (see section *Selecting the Power Unit for All Installed Modules*, p. 38). You cannot set the power unit of an individual module.

- Procedure**
1. Access the SLD **Unit Setup** menu (see section *Accessing an OSICS Module Setup Menu*, p. 33).
  2. Turn the rotary knob to put the cursor before the **Set Power** menu and press the knob.

The **Set Power** menu appears and displays the current power setting.

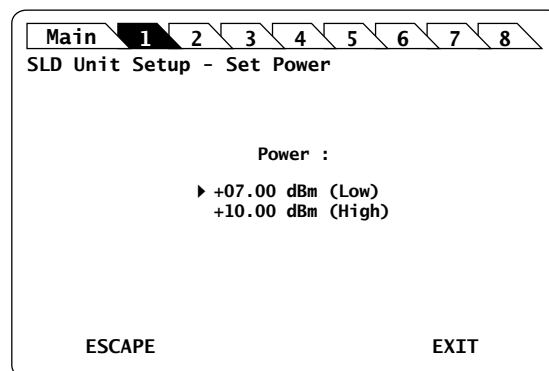

Figure 65: SLD Unit Setup – Set Power menu

3. Turn the rotary knob to put the cursor before the wanted setting, and press it to validate your selection.

The **Unit Setup** menu is automatically displayed and the optical power value of the module is now modified (according to the module power limits).

MAIN

ATN

BKR

DFB

**SLD**

SWT

SWT APC

T100



# 10. Using the OSICS SWT Module

This section explains how to operate the OSICS SWT via the SWT **Unit Setup** menu. For more details on how to install and initialize the module into the OSICS Mainframe, see section *Installing and Connecting the OSICS Multifunction Platform*, p. 21.

## 10.1 OSICS SWT Presentation

### Features

The OSICS SWT is a full suite of fiber optic switch and shutter modules based on optical prism technology.

- The **1x1** configuration is a shutter. It allows to block/pass an optical signal with high isolation.
- The **2x(1x1)** configuration is a 2x shutter. It features two 1x1 configurations. The first one is called Shutter A-B, the second one Shutter 1-2. They can be operated simultaneously as well as individually.
- The **2x2** switch configuration allows to cross (or not) two input and two output channels.
- The **1x2** and **1x4** switch configuration features one common input/output channel (Com), and 2 or 4 output/input channels (Ch1 and Ch2 or Ch1, Ch2, Ch3 and Ch4) to be used sequentially.

The OSICS SWT module is fully bi-directional: you can use the module as 1 input and 2 or 4 outputs (see *Figure 66*, p. 105), or 1 output and 2 or 4 inputs (see *Figure 67*, p. 105), depending on the needs of your measurement setup.

- In a standard configuration, it allows you to direct a laser signal from the common channel *Com* to any output channel *Ch1* to *Chn*, as shown in the following figure:

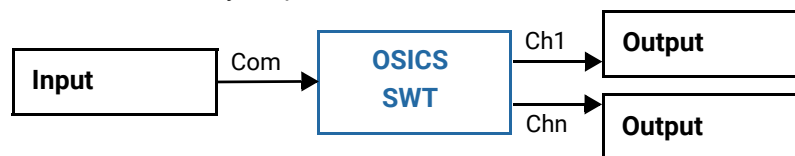

Figure 66: SWT Standard Configuration

- In a reverse configuration, you can direct any signal one after another from *Ch1* to *Chn* to the common channel *Com* as illustrated in the following figure:



Figure 67: SWT Reverse Configuration

The SWT optical-switch module can be combined with a variety of modular sources such as tunable external cavity laser (T100) and distributed feedback laser diode (DFB), within the same OSICS multifunction platform.

**Examples of SWT Implementations**

**Measurement of Two Laser Sources with a Wavemeter**

If you want two laser sources to share the same measurement device (such as a wavemeter), you can connect two laser sources to Ch1 and Ch2, which can then be sequentially measured during a specific time frame (if you define one):

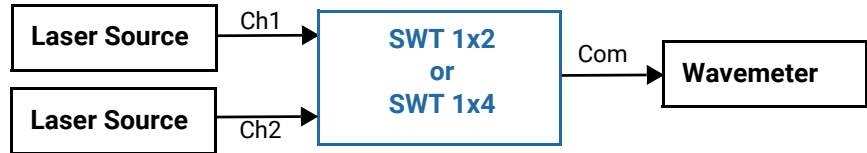

Figure 68: SWT Implementation Example – Two Laser Sources and a Wavemeter

**Sequential Testing of Two or Four Devices**

To sequentially test two or four devices, you can use two OSICS SWT modules. A laser source and the input of the devices-under-test are connected to the first module. The output of the devices-under-test are connected to the second module, which sequentially directs the signal to a unique measurement device:

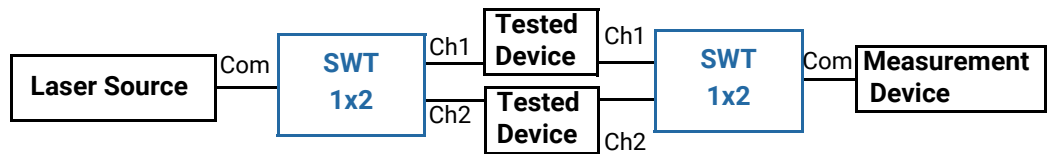

Figure 69: SWT Implementation Example – Sequential Testing of Two or Four Devices

**Testing of an Optical Amplifier**

To test an optical amplifier, you need to connect both the non-amplified and amplified signals to a measurement device. In this setup two OSICS SWT modules are needed.

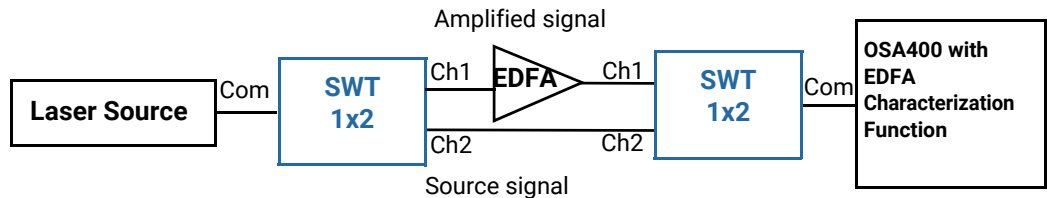

Figure 70: SWT Implementation Example – Testing of an Optical Amplifier

## 10.1.1 OSICS SWT Technical Specifications

	SMF <sup>*1</sup>	PMF
Available Configurations	1x1; 2x(1x1); 1x2; 1x4; 2x2	
Spectral Range (nm)	1260–1630	On PM15: 1480–1630 On PM13: 1240–1510
Insertion Loss <sup>*2*3</sup>	≤ 1 dB	≤ 1.5 dB
Polarization Dependent Loss <sup>*2</sup>	PDL ≤ 0.1 dB	PER ≥ 20 dB
Repeatability <sup>*3</sup>	≤ 0.005 dB	≤ 0.01 dB
Return Loss <sup>*2</sup>	> 55 dB	
On/Off ratio (1x1 Shutter Only)	≥ 80 dB	
On/Off ratio (2x(1x1) Shutter Only)	≥ 65 dB	
Crosstalk <sup>*3</sup>	≥ 55 dB	
Switching Time	30 ms typ.	
Guaranteed Lifetime (number of cycle)	> 10 <sup>8</sup>	
Input/Output Fiber Type	SMF-28 fiber	PM15 or PM13
Connector Type <sup>*4</sup>	FC/APC narrow key	
Dimensions W x H x D	35 x 128 x 230 mm (1.4 x 5.0 x 9.0 in)	
Weight	1 kg (2.21 lb)	
Temperature Range	+15 to +35 °C (+59 to +95 °F)	

\*1: Specifications apply for wavelengths not equal to any water absorption line

\*2: Typical values including connectors. Maximum insertion loss is 1.4 dB for SMF and 2.0 dB for PMF.

\*3: On the whole wavelength range.

\*4: For PMF, slow axis is aligned to the connector key.

## 10.1.2 OSICS SWT Module Overview

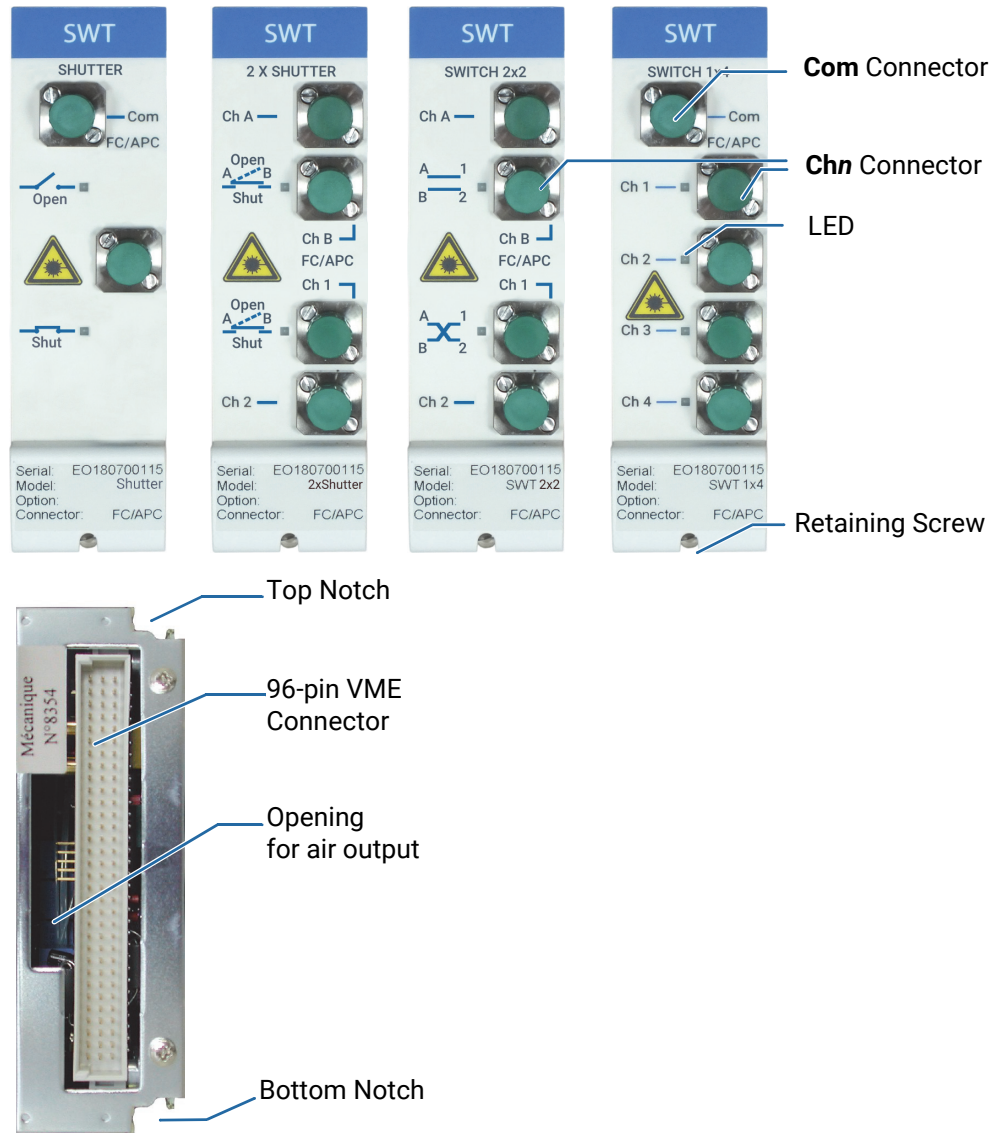

Figure 71: SWT Module – Front and Rear Panels

### Front Panel

#### Com Connector (on SWT 1x1, 1x2 and 1x4)

Fiber optic connector. It is a standard input/output FC/APC type connector. For more details on the appropriate fiber type, see section *OSICS SWT Technical Specifications*, p. 107.

#### Chn Connector and LEDs

Fiber optic connector. It is a standard input/output FC/APC type connector. For more details on the appropriate fiber type, see section *OSICS SWT Technical Specifications*, p. 107.

The green LEDs indicates which channel (SWT 1x2, SWT1x4) or output mode is currently active. If the channel is enabled, the LED is lit and the corresponding information is

displayed in the **System Status** screen (see section *System Status Screen Description*, p. 30).



**Caution**

On OSICS SWT, do not connect several laser sources at the same time on the **Com** and **Chn** channels, or you may severely damage your optical equipment.

The  label located on the front panel indicates the locations of the laser output.



**Warning**

Do not look directly into the fiber end of an optical cable connected to any optical output while the device is in use. This may cause permanent eye damage.

**Retaining Screw**

The captive screw enables you to lock/unlock the module inserted into the slot of the OSICS Mainframe.



**Caution**

The OSICS Mainframe does not support "hot-swap" of modules; for more details, see section *Handling OSICS Modules Into the OSICS Mainframe*, p. 23).

**Rear Panel**

**Notches**

The top and bottom notches enable you to slide the module into the OSICS Mainframe slot (see section *Installing an OSICS Module Into the OSICS Mainframe*, p. 23).

**96-pin VME Connector**

The rear panel of the OSICS modules interfaces with the OSICS Mainframe backplane by means of the 96-pin VME connector.

**Opening**

The opening ensures proper flow of cooled air drawn from the OSICS Mainframe chassis.

**Side Panel**

The labels affixed on the side panel of the OSICS SWT are described in section *OSICS Information and Warning Markings*, p. 19.

## 10.2 Selecting the OSICS SWT Input/Output

**Subject** This section explains how to select the channel through which the signal will be directed. You can only activate one output channel at a time. For SWT 1x1, this section explains how to open or shut the switch.

**Procedure**

1. Access the SWT **Unit Setup** menu (see section *Accessing an OSICS Module Setup Menu*, p. 33).
2. Turn the rotary knob to put the cursor before the **Select Channel** (for SWT 1x2 or 1x4) or **Select Output Mode** (for SWT 1x1, 2x2 or 2x(1x1)) menu and press the knob.

The **Select Channel** (for SWT 1x2 or 1x4) or **Select Output Mode** (for SWT 1x1, 2x2 or 2x(1x1)) menu appears and indicates the currently active SWT channel or output mode with a cross next to the selected channel.

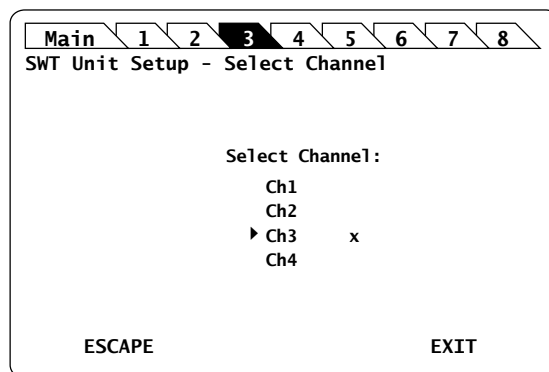

Figure 72: SWT Unit Setup – Channel Selection menu (SWT 1x4 Example Screen)

3. Turn the rotary knob to put the cursor before the channel or output mode you want to activate and press it to validate your selection.

The corresponding channel is immediately activated and a cross appears next to the selected channel.

On the SWT front panel, the LED corresponding to the selected channel or output mode is lit.

On SWT 2x(1x1), the LED is lit if the switch is shut.

4. Press one of the following control buttons:
  - **ESCAPE**: to go back to the SWT **Unit Setup** menu.
  - **EXIT**: to display the **System Status** screen.

In the **System Status** screen, the selected channel number or output mode is displayed in the corresponding SWT channel **Info** field.

## 10.3 Configuring Sequential Switching

You can configure sequential switching for each SWT module individually from the **Unit Setup** menu.

The sequence activates each channel one after the other from channel 1 to channel 2 (for SWT 1x2), from channel 1 to channel 4 (for SWT 1x4), from Bar to Cross (for SWT 2x2) or from Shut to Open (for SWT 2x(1x1)) according to the configured timeframe and number of scans. You cannot select a different order.

The sequence can be executed once or continuously.

### 10.3.1 Selecting the Number of Scans

**Subject** You can select from 1 to 1000 scans in continuous.

**Procedure**

1. Access the SWT **Unit Setup** menu (see section *Accessing an OSICS Module Setup Menu*, p. 33).
2. Expand the **Sequence Switching** menu and enter the **Number of Scans** sub-menu. The sub-menu appears and displays the current configured number of scans.

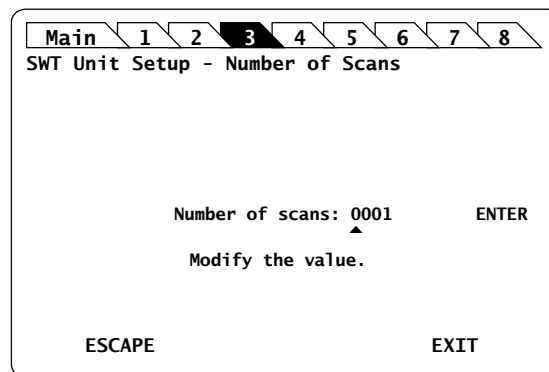

Figure 73: SWT Unit Setup – Sequence Switching - Number of Scans

3. Modify the number of scan as follows:
  - a. Turn the rotary knob to put the cursor under the digit you want to modify and press the knob to highlight it.
  - b. Turn the knob clockwise to increase the value or anticlockwise to decrease it and press the knob to validate the selected digit.
  - c. Perform steps a. and b. again with the other digits to modify.
  - d. Turn the rotary knob clockwise to put the cursor under **ENTER** and press the knob to validate the new step value.

The number of scans is set and the **Unit Setup** menu is automatically displayed.

## 10.3.2 Setting the Timeframe

**Subject** You can set a different period of time for each channel or output mode individually, or the same period of time for all; from 0.1 s to 48 h.

- Procedure**
1. Access the **SWT Unit Setup** menu (see section *Accessing an OSICS Module Setup Menu*, p. 33).
  2. Expand the **Sequence Switching** menu and enter the **Set Delays** sub-menu.  
The sub-menu appears and displays the available channels (for SWT 1x2 or 1x4) or output modes (for SWT 2x2 or 2x(1x1)).
  3. Do one of the following:
    - If you want to set the same period of time for all channels or output modes, turn the rotary knob to put the cursor before **All** and press the knob to validate your selection.
    - If you want to set a different period of time for an individual channel or output mode, turn the rotary knob to put the cursor before the channel or mode you want to configure and press the knob to validate your selection.

The time setting sub-menu appears

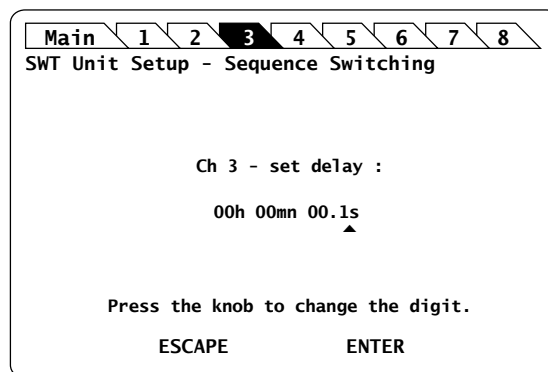

Figure 74: SWT Unit Setup – Sequence Switching - Set delay (SWT 1x4 Example Screen)

4. Modify the time value as follows:
  - a. Turn the rotary knob to put the cursor under the digit you want to modify and press the knob to highlight it.
  - b. Turn the knob clockwise to increase the value or anticlockwise to decrease it and press the knob to validate the selected digit.
  - c. Perform steps a. and b. again with the other digits to modify.
  - d. Press the ENTER control button to validate the time set.

The timeframe is set for the selected channel or mode. The channel or mode selection menu is displayed.
5. Perform steps 3. and 4. on each channel or mode for which you want to set a particular period of time.
6. Press the ESCAPE control button to validate your configuration and go back to the **Unit Setup** screen.



### 10.3.3 Launching/Stopping a Sequence

- Subject** The **Control** sub-menu enables you to launch the sequence once or continuously.
- Before Starting** Make sure the sequence number of scans (see section *Selecting the Number of Scans*, p. 111) and time (see section *Setting the Timeframe*, p. 112) are set.
- Procedure**
1. Access the SWT **Unit Setup** menu (see section *Accessing an OSICS Module Setup Menu*, p. 33).
  2. Expand the **Sequence Switching** menu and enter the **Control** sub-menu.

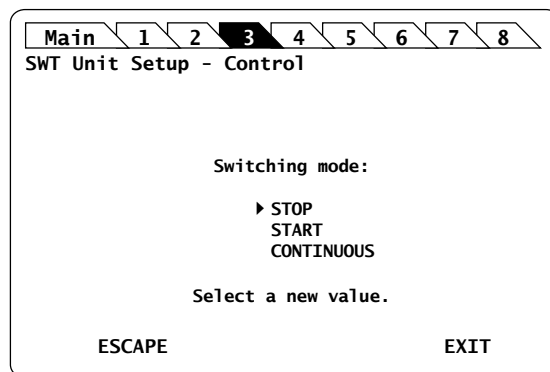

Figure 75: SWT Unit Setup – Sequence Switching - Control

3. Turn the rotary knob to put the cursor before the wanted action:
  - **STOP**: the SWT module executes the sequence once.
  - **CONTINUOUS**: the SWT module executes the sequence continuously. The sequence will only stop if you select the STOP action.
4. Press the knob to start the sequence switching.  
The sequence starts. In the **System Status** screen, an **s** and the currently activated channel or mode are displayed in the corresponding SWT module **Info** field.
5. To stop the sequence if you have selected CONTINUOUS: in the **Control** sub-menu, turn the rotary knob to put the cursor before **STOP** and press the knob to confirm your selection.

## 10.4 Testing the Performance of the SWT Module

Use the procedures described in this section to validate warranted specifications of the OSICS SWT module, as needed.

### 10.4.1 Preparing Performance Tests

#### Before Starting

Make sure you have the following required equipment for conducting performance tests on OSICS SWT modules:

Equipment	Minimum Requirement
Optical power meter (x2)	Wavelength range: 1250 nm to 1650 nm Resolution: < 0.001 dB Dynamic range: > 70 dB
Laser source	Wavelength range: 1250 to 1650 nm
Fiber optic coupler	FC/APC connectors

The various types as well as the number of fiber-optic connectors needed may vary depending on the type of equipment used and the distance between the test equipment and the OSICS SWT modular optical source under test.



#### Warning

- Disable the laser output before connecting or disconnecting a fiber optic cable on the module (see section *Enabling/Disabling the Light Source of All Modules*, p. 37).
- Do not look directly into the fiber end of an optical cable connected to any optical output while the device is in use. This may cause permanent eye damage.

#### Procedure

1. In the OSICS Mainframe, install the SWT modules you want to test.
2. Turn-on the OSICS multifunction platform (see section *Turning on the OSICS Multifunction Platform and Accessing the System Status Screen*, p. 29).
3. Let the OSICS multifunction platform and other test equipments run continuously for 2 hours at room temperature (within the specified operating temperature range) to achieve proper equipment warm-up.

## 10.4.2 Verifying the Repeatability

### Subject

This procedure verifies that the SWT module repeatability is within specification range over 100 measurements for each channel.

The following figure illustrates the appropriate setup to perform the repeatability test:

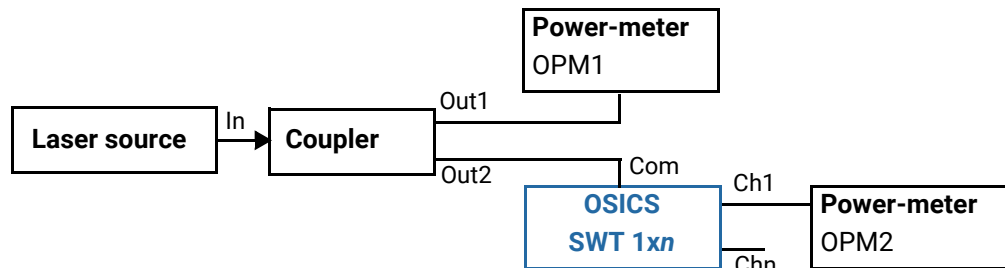

Figure 76: SWT Performance Test – Repeatability

### Before Starting

Make sure you have the appropriate power-meter (see section *Preparing Performance Tests*, p. 114).

### Procedure

1. Disable all laser source outputs and other modules in the OSICS Mainframe.
2. Connect the measurement equipments as indicated on *Figure 76*, p. 115.
3. If you are using an OSICS T100 or OSICS DFB as the external source, enable the laser output.
4. Enable the output channel under test (in our example **Ch1**) and record the power output value P1 and P2 provided respectively by OPM1 and OPM2 after the power reading has stabilized.
5. Select dBm as the power-meter measurement unit and hold the range on OPM2 for better accuracy.
6. Turn off and on Ch1 for 100 times, and record each time the power reading P1 and P2 (in dBm) on both power-meters OPM1 and OPM2.
7. Subtract OPM2 reading from OPM1 reading (P1-P2) for each of the 100 measurements and record the result.
8. Find the maximum ( $|P1-P2|_{\max}$ ) and minimum ( $|P1-P2|_{\min}$ ) values among the  $|P1-P2|$  records calculated in step 6. above.
9. Subtract the maximum and minimum values to get the module repeatability.
10. Verify that the calculated repeatability value is within the specification range of 0.02 dB.
11. Perform the same operations for the second OSICS SWT module channel.

### 10.4.3 Verifying the Crosstalk

**Subject** The following figure illustrates the appropriate setup to perform the crosstalk test:



Figure 77: SWT Performance Test – Crosstalk

**Before Starting** Make sure you have the appropriate power-meter (see section *Preparing Performance Tests*, p. 114).

- Procedure**
1. Disable all laser source outputs and other modules in the OSICS Mainframe.
  2. Connect the measurement equipments as indicated on *Figure 77*, p. 116.
  3. Select dBm as the power-meter unit.
  4. Select the channel (Ch1 in our example) that you want to measure.
  5. Record the power value provided by the power-meter.
  6. Switch the laser signal to another channel, while the power-meter is still measuring Ch1.
  7. Record the power on the power-meter.
  8. Subtract the second power from the first measure to get the crosstalk.
  9. Verify that the calculated value is over the specified value of 50 dB.
  10. Perform the same operation for the Chn SWT channel.

# 11. Using the OSICS SWT APC Module

This section explains how to operate the OSICS SWT APC via the SWT APC **Unit Setup** menu. For more details on how to install and initialize the module into the OSICS Mainframe, see section *Installing and Connecting the OSICS Multifunction Platform*, p. 21.

## 11.1 OSICS SWT APC Presentation

### Features

The OSICS SWT APC is an optical-switch module that comes in a 1x2 or 1x4 configuration: one common input/output channel and two or four output/input channels (Ch1 and Ch2 or Ch1, Ch2, Ch3 and Ch4) to be used sequentially.

You can use the OSICS SWT APC module as a bi-directional switch, or as a tunable laser, as explained below.

The OSICS SWT APC module can only be used with OSICS Mainframe v. 3.01 and higher versions.

### OSICS SWT APC Used in Switch Mode

The OSICS SWT APC module is fully bi-directional: you can use the module as 1 input and 2 or 4 outputs (see *Figure 78*, p. 117), or 1 output and 2 or 4 inputs (see *Figure 79*, p. 117), depending on the needs of your measurement setup.

- In a standard configuration, it allows you to direct a laser signal from the common channel *Com* to any output channel *Ch1* to *Chn*, as shown in the following figure:



Figure 78: SWT APC Standard Configuration

- In a reverse configuration, you can direct any signal one after another from *Ch1* to *Chn* to the common channel *Com* as illustrated in the following figure:



Figure 79: SWT APC Reverse Configuration

The SWT APC optical-switch module can be combined with a variety of modular sources such as tunable external cavity laser (T100) and distributed feedback laser diode (DFB), within the same OSICS multifunction platform.

**OSICS SWT APC Used in Full-Band Mode**

Using T100 modules, you can use the SWT APC as a tunable laser: from the OSICS SWT APC setup menu you can drive in power and wavelength from 1 to 4 T100 module(s) as illustrated in the following figure.

A monitoring photodiode checks the optical output power of the module.

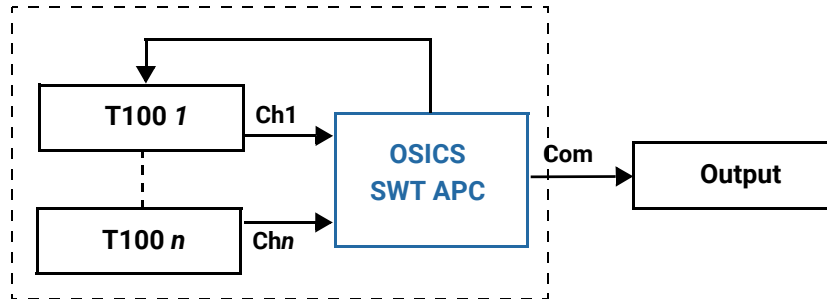

Figure 80: SWT APC in T100 Full-Band Configuration

The OSICS SWT APC module can drive the T100 modules only if they are located in the same OSICS Mainframe.

**Examples of SWT APC Implementations**

**Measurement of Two Laser Sources with a Wavemeter**

If you want two laser sources to share the same measurement device (such as a wavemeter), you can connect two laser sources to Ch1 and Ch2, which can then be sequentially measured during a specific time frame (if you define one):

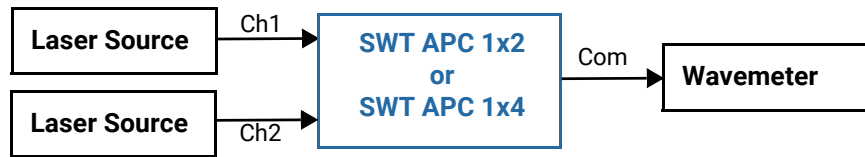

Figure 81: SWT APC Implementation Example – Two Laser Sources and a Wavemeter

**Sequential Testing of Two or Four Devices**

To sequentially test two or four devices, you can use two OSICS SWT APC modules. A laser source and the input of the devices-under-test are connected to the first module. The output of the devices-under-test are connected to the second module, which sequentially directs the signal to a unique measurement device:

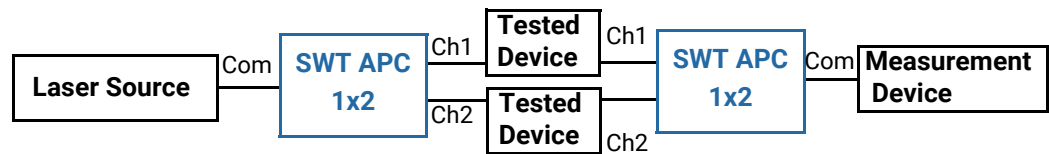

Figure 82: SWT APC Implementation Example – Sequential Testing of Two or Four Devices

**Testing of an Optical Amplifier**

To test an optical amplifier, you need to connect both the non-amplified and amplified signals to a measurement device. In this setup two OSICS SWT APC modules are needed.

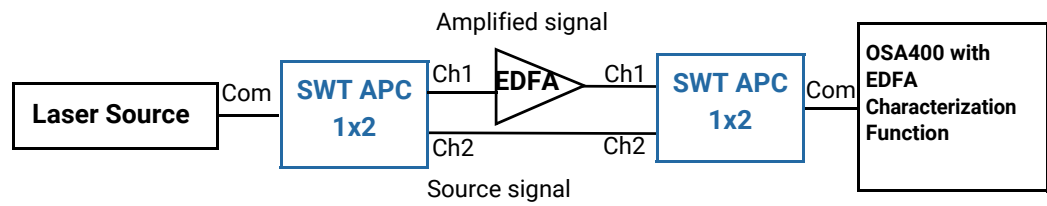

Figure 83: SWT APC Implementation Example – Testing of an Optical Amplifier

### Testing of an Optical Device over a Wide Spectrum

To test an optical device over a wide spectrum, you must employ several tunable lasers with distinct wavelength coverage:

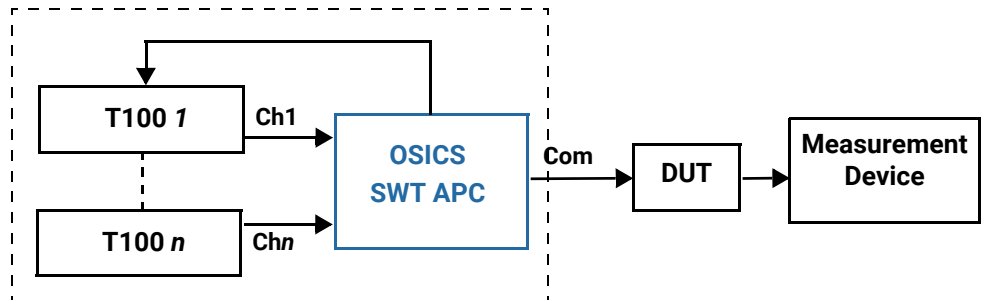

Figure 84: SWT APC Implementation Example – Testing a DUT over a Wide Spectrum

## 11.1.1 OSICS SWT APC Technical Specifications

	<b>OSICS SWT APC</b>
Spectral Range (nm)	1250-1650 nm
Insertion Loss <sup>*1*2</sup>	< 1.5 dB
Polarization Dependent Loss <sup>*1*3</sup>	< 0.1 dB
Repeatability <sup>*2*4</sup>	±0.02 dB
Return Loss <sup>*1</sup>	> 50 dB
Crosstalk <sup>*2</sup>	> 50 dB
Optical Input/Output Connectors (Module Front Panel)	FC/APC narrow key
Automatic Power Control	Yes (with OSICS T100)
Input/Output Fiber Type	SMF-28 fiber
Synchronization (mainframe)	BNC connector N2: 50 ms TTL pulses
Dimensions W x H x D	35 x 128 x 230 mm (1.4 x 5.0 x 9.0 in)
Weight	1 kg (2.21 lb)
Temperature Range	15-35 °C

Specifications apply for wavelengths not equal to any water absorption line.

\*1: Including connectors.

\*2: On the whole wavelength range.

\*3: At 1550 nm.

\*4: At constant temperature, over 100 successive cycles.



## 11.1.2 OSICS SWT APC Module Overview

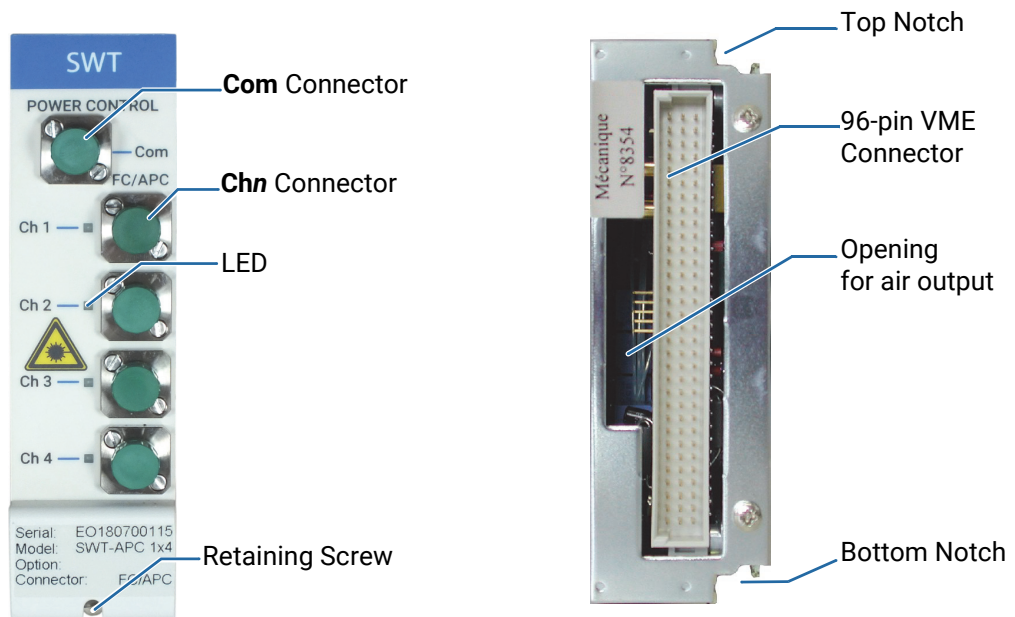

Figure 85: SWT APC Module – Front and Rear Panels

### Front Panel

#### Com Connector

Fiber optic connector. It is a standard input/output FC/APC type connector. For more details on the appropriate fiber type, see section *OSICS SWT APC Technical Specifications, p. 120*.

#### Chn Connector and LEDs

Fiber optic connector. It is a standard input/output FC/APC type connector. For more details on the appropriate fiber type, see section *OSICS SWT APC Technical Specifications, p. 120*.

The green LEDs indicates which channel is currently active. If the channel is enabled, the LED is lit and CHn is displayed in the System Status screen (see section *System Status Screen Description, p. 30*).



#### Caution

Do not connect several laser sources at the same time on the **Com** and **Chn** channels, or you may severely damage your optical equipment.



The  label located on the faceplate indicates the locations of the laser source.



#### Warning

Do not look directly into the fiber end of an optical cable connected to any optical output while the device is in use. This may cause permanent eye damage.

**Retaining Screw**

The captive screw enables you to lock/unlock the module inserted into the slot of the OSICS Mainframe.

**Caution**

The OSICS Mainframe does not support "hot-swap" of modules; for more details, see section *Handling OSICS Modules Into the OSICS Mainframe*, p. 23).

**Rear Panel****Notches**

The top and bottom notches enable you to slide the module into the OSICS Mainframe slot (see section *Installing an OSICS Module Into the OSICS Mainframe*, p. 23).

**96-pin VME Connector**

The rear panel of the OSICS modules interfaces with the OSICS Mainframe backplane by means of the 96-pin VME connector.

**Opening**

The opening ensures proper flow of cooled air drawn from the OSICS Mainframe chassis.

**Side Panel**

The labels affixed on the side panel of the OSICS SWT APC are described in section *OSICS Information and Warning Markings*, p. 19.

## 11.2 Selecting the Operating Mode

**Subject**

You can operate the SWT APC in Switch or Full-Band mode. In the **Unit Setup** menu, the **Mode** : menu displays the active mode.

**Procedure**

1. Access the SWT APC **Unit Setup** menu (see section *Accessing an OSICS Module Setup Menu*, p. 33).  
The **Mode** : menu display the currently active mode:
2. Turn the rotary knob to put the cursor before the **Mode : Switch** or **Mode : Full-Band** menu.
3. Press the knob to toggle from one mode to another.  
The **Mode** : menu displays the selected mode and the corresponding setting menus are displayed.
4. If you set the module to **Full-Band** mode, you must configure the modules connected to the SWT APC module as explained in section *Configuring the Full-Band Mode*, p. 124.

## 11.3 Selecting the OSICS SWT APC Input/Output Channel (Switch Mode)

**Subject** This section explains how to select the channel through which the signal will be directed. You can only activate one output channel at a time.

**Procedure**

1. Access the SWT APC **Unit Setup** menu (see section *Accessing an OSICS Module Setup Menu*, p. 33).
2. Set the SWT APC to **Switch** mode (see section *Selecting the Operating Mode*, p. 122).
3. Turn the rotary knob to put the cursor before the **Select Channel** (for SWT APC 1x2 or 1x4) or **Select Output Mode** (for SWT APC 2x2 or 2x(1x1)) menu and press the knob. The **Channel Selection** menu appears and indicates the currently active SWT APC channel or output mode with a cross next to the selected channel.

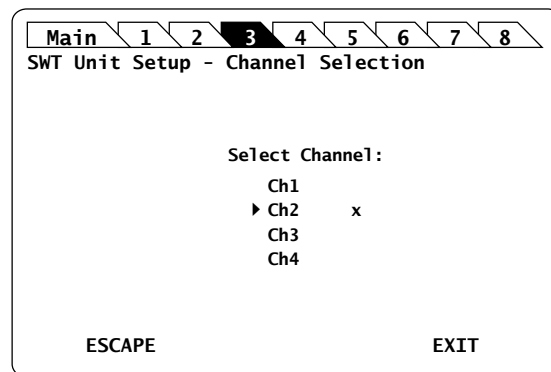

Figure 86: SWT APC Unit Setup – Channel Selection menu (SWT APC 1x4 Example Screen)

4. Turn the rotary knob to put the cursor before the channel or output mode you want to activate and press it to validate your selection.

The corresponding channel is immediately activated and a cross appears next to the selected channel.

On the SWT APC front panel, the LED corresponding to the selected channel or output mode is lit.

5. Press one of the following control buttons:
  - **ESCAPE**: to go back to the SWT APC **Unit Setup** menu.
  - **EXIT**: to display the **System Status** screen.

In the **System Status** screen, the selected channel number or output mode is displayed in the corresponding SWT APC channel **Info** field.

## 11.4 Configuring the Full-Band Mode

The OSICS SWT APC optical switch module enables you to drive from 1 to 2 or to 1 to 4 (depending on your SWT APC model) OSICS T100 modules plugged in the same OSICS Mainframe: you select a wavelength and an output power in the OSICS SWT APC setup menu, and the module automatically selects the channel and drives the OSICS T100 to provide the wanted values.

To use the OSICS SWT APC in Full-Band mode, the module must know where OSICS T100 modules are located in the Mainframe. For this, you can use one of the following methods:

- **Manual configuration:** use this method if an OSICS T100 is running with another application.
- **Automatic detection:** use this method if the OSICS T100 modules installed in the Mainframe are not running for other applications.

### 11.4.1 Automatically Detecting the T100 Modules Connected to the SWT APC

<b>Subject</b>	The OSICS T100 modules already installed in the Mainframe (not being used by other applications) can be automatically detected by the OSICS SWT APC module. The auto configuration takes approximately 20 seconds. During this operation, the optical outputs of the connected OSICS T100 are sequentially turned off and on.
<b>Before Starting</b>	<ul style="list-style-type: none"> <li>• Connect the wanted OSICS T100 to the input ports of the OSICS SWT APC Ch1 to Chn.</li> <li>• Set the SWT APC to <b>Full-Band</b> mode (see section <i>Selecting the Operating Mode</i>, p. 122) and configure the connected modules (section <i>Configuring the Full-Band Mode</i>, p. 124).</li> </ul>
<b>Procedure</b>	<ol style="list-style-type: none"> <li>1. Access the SWT APC <b>Unit Setup</b> menu (see section <i>Accessing an OSICS Module Setup Menu</i>, p. 33).</li> <li>2. Expand the <b>ECL vs Channel</b> menu enter the <b>Auto</b> menu. The <b>ECL vs Channel</b> menu appears, prompting you to start the detection.</li> <li>3. Press the knob to start the detection. The SWT APC sequentially disables and enables the optical output of the connected OSICS T100 modules. If two OSICS T100 modules have common wavelengths, the SWT APC selects the first module in the mainframe to achieve the range. Once the automatic detection is complete the automatically detected values are displayed.</li> </ol>

Main	1	2	3	4	5	6	7	8
SWT Unit Setup - ECL vs Channel								
Ch	ECL	$\lambda_{\min}$ (nm)	$\lambda_{\max}$ (nm)					
1	2	1260	1360					
2	6	1360	1470					
▶ 3	3	1460	1580					
4	8	1560	1680					
Press the knob to change the digit.								
ESCAPE				ENTER				

Figure 87: SWT APC Setup – Channel Configuration menu (1x4 Example Screen)

4. Do one of the following:
  - If you want to manually change the configuration, modify the wanted wavelength range as explained in section *Manually Configuring the T100 Modules Connected to the SWT APC*, p. 125.
  - If you don't want to modify the displayed values press the ENTER control button.

The module configuration is validated and the SWT APC **Unit Setup** screen is displayed.

## 11.4.2 Manually Configuring the T100 Modules Connected to the SWT APC

<b>Subject</b>	If one of your OSICS T100 is used by other applications, you can manually configure the OSICS T100 modules connected to your SWT APC module.
<b>Before Starting</b>	<ul style="list-style-type: none"> <li>• Connect the wanted OSICS T100 to the input ports of the OSICS SWT APC Ch1 to Chn.</li> <li>• Set the SWT APC to <b>Full-Band</b> mode (see section <i>Selecting the Operating Mode</i>, p. 122) and configure the connected modules (section <i>Configuring the Full-Band Mode</i>, p. 124).</li> </ul>
<b>Procedure</b>	<ol style="list-style-type: none"> <li>1. Access the SWT APC <b>Unit Setup</b> menu (see section <i>Accessing an OSICS Module Setup Menu</i>, p. 33).</li> <li>2. Expand the <b>ECL vs Channel</b> menu enter the <b>Edit</b> menu. The <b>ECL vs Channel</b> configuration screen appears and displays the following information:           <ul style="list-style-type: none"> <li>• <b>Ch</b> column: SWT APC input port number.</li> <li>• <b>ECL</b> column: mainframe slot number in which is installed the T100 module.</li> <li>• <b><math>\lambda_{\min}/\lambda_{\max}</math></b> columns: wavelength range of the connected module in nm.</li> </ul> </li> </ol>

Ch	ECL	$\lambda_{min}$ (nm)	$\lambda_{max}$ (nm)
1	2	1260	1360
2	6	1360	1470
▶ 3	3	1460	1580
4	8	1560	1680

Press the knob to change the digit.

ESCAPE                                  ENTER

Figure 88: SWT APC Setup – Channel Configuration menu (1x4 Example Screen)

3. Turn the rotary knob to put the cursor before the channel you want to modify and press it to validate your selection.

The corresponding **ECL** slot number is highlighted.

4. Modify the wanted values as follows:

If you select for two channels the same OSICS T100, the new selection cancels the previous one.

- e. Turn the knob clockwise to increase the value or anticlockwise to decrease it of the slot.

Available slot numbers are the one where T100 are located.

If you have a channel without OSICS T100 connected on, select the -- symbols.

In the  $\lambda$  column, the wavelength limits are automatically defined for OSICS T100 with version higher than 2.21.

- f. Press the knob to validate the selected digit.

The following column digit is highlighted

- g. Turn the knob clockwise to increase the value or anticlockwise to decrease it and press the knob to validate the selected digit.

- h. Perform steps a. to c. again with the other digits to modify.

- i. Press the ENTER control button to validate the channel configuration.

5. Perform steps 3. and 4. again with the other channels to modify.

6. Press the ENTER control button again to validate the overall channel configuration.

The module configuration is validated and the SWT APC **Unit Setup** screen is displayed.

## 11.5 Enabling/Disabling the Light Source of all Connected Modules (Full-Band Mode)

**Subject** In Full-Band mode, you can enable/disable the laser of all modules connected to the SWT APC, as explained in the following procedure.

**Before Starting**

- Connect an optical device to the OSICS SWT APC (see section *Connecting Optical Devices to OSICS Modules*, p. 26).



### Warning

- Do not enable the laser while there is no fiber connected to the optical output connector.
  - Do not look directly into the fiber end of an optical cable connected to any optical output while the device is in use. This may cause permanent eye damage.
- Set the SWT APC to **Full-Band** mode (see section *Selecting the Operating Mode*, p. 122) and specify the connected modules (section *Configuring the Full-Band Mode*, p. 124).

### Procedure

#### Enabling the Light Source of All Connected Modules

1. Access the SWT APC **Unit Setup** menu (see section *Accessing an OSICS Module Setup Menu*, p. 33).
2. Turn the rotary knob to put the cursor before the **Optical Output : DISABLED** menu.
3. Press the rotary knob to enable the laser of all installed modules.

The OSICS modules beep and the laser is enabled on all connected modules simultaneously (the green **Enable** LED of all modules lights on).

The menu displays **Optical Output : ENABLED**.

#### Disabling the Light Source of All Connected Modules

1. Access the SWT APC **Unit Setup** menu (see section *Accessing an OSICS Module Setup Menu*, p. 33).
2. Turn the rotary knob to put the cursor before the **Optical Output : ENABLED** menu.
3. Press the rotary knob to disable the laser of all connected modules.

The laser is disabled on all modules simultaneously (the green **Enable** LED of all modules lights off).

## 11.6 Setting the Optical Output Power of the SWT APC Module (Full-Band Mode)

### Subject

You can set the optical output power in two different ways:

- From the OSICS Mainframe **Main Setup** menu, you can simultaneously set the optical power of all modules to the same value: see section *Setting the Optical Output Power of All Installed Modules*, p. 38.
- From the SWT APC **Unit Setup** menu, you can set the output power of the module individually as explained in the following procedure.

In Full-Band mode, you can set the optical output power of the SWT APC module, which drives the T100 output power with its integrated photodiode, to get a continuous output power on the whole range of wavelength.

If you change the wavelength or the output power, the photodiode in the OSICS SWT APC monitors an optical power that is not the real time optical power adjustment (this function is done by the OSICS T100).

The power value is software-limited by the SWT APC in a range between -6.99 dBm and +3 dBm.

### Before Starting

- Set the optical power unit from the OSICS Mainframe **Main Setup** menu (see section *Selecting the Power Unit for All Installed Modules*, p. 38). You cannot set the power unit of an individual module.
- Set the SWT APC to **Full-Band** mode (see section *Selecting the Operating Mode*, p. 122) and specify the connected modules (section *Configuring the Full-Band Mode*, p. 124).

### Procedure

1. Access the SWT APC **Unit Setup** menu (see section *Accessing an OSICS Module Setup Menu*, p. 33).
2. Turn the rotary knob to put the cursor before the **Set Power** menu and press the knob.

The **Set Power** menu appears and displays the current power setting.

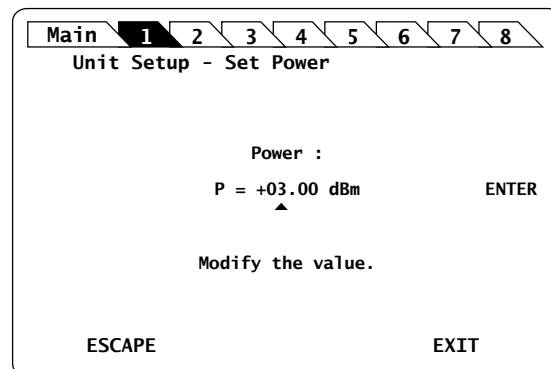

Figure 89: SWT APC Unit Setup – Set Power menu

3. Modify the power value as follows:
  - a. Turn the rotary knob to put the cursor under the digit of +/- sign you want to modify and press the knob to highlight it.
  - b. Turn the knob clockwise to increase the value or anticlockwise to decrease it and press the knob to validate the selected digit.
  - c. Perform steps a. and b. again with the other digits to modify.



- d. Turn the rotary knob clockwise to put the cursor under **ENTER** and press the knob to validate the new power value.

The **Unit Setup** menu is automatically displayed and the optical power value of the module is now modified (according to the module power limits).

## 11.7 Setting the Optical Emission Wavelength/Frequency (Full-Band Mode)

### 11.7.1 Specifying the Optical Emission Wavelength/Frequency

- Subject** The following procedure explains how to set the emission wavelength or optical frequency of the OSICS SWT APC. The available range is defined by the **ECL vs Channel** configuration panel of the OSICS SWT APC (see section *Configuring the Full-Band Mode*, p. 124).
- Before Starting**
- Set the spectral unit from the OSICS Mainframe **Main Setup** menu (see section *Selecting the Spectral Unit for all Installed Modules*, p. 39). You cannot set the spectral unit of an individual module.
  - Set the SWT APC to **Full-Band** mode (see section *Selecting the Operating Mode*, p. 122) and specify the connected modules (section *Configuring the Full-Band Mode*, p. 124).
- Procedure**
1. Access the SWT APC **Unit Setup** menu (see section *Accessing an OSICS Module Setup Menu*, p. 33).
  2. Turn the rotary knob to put the cursor before the **Set  $\lambda$ /f** menu and press the knob. The **Set Wavelength** or **Set Frequency** (depending on the selected spectral unit) menu appears and displays the emission wavelength or frequency.

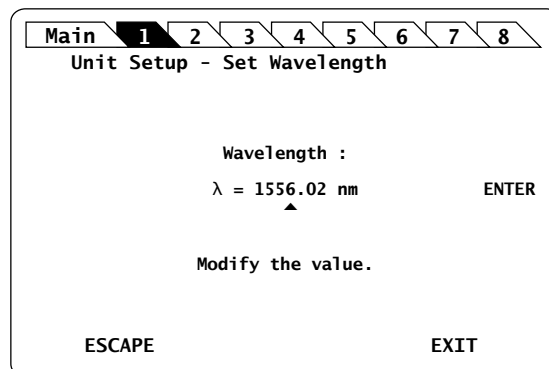

Figure 90: SWT APC Unit Setup – Set Wavelength/Frequency menu

3. Modify the wavelength/frequency value as follows:
  - a. Turn the rotary knob to put the cursor under the digit you want to modify and press the knob to highlight it.
  - b. Turn the knob clockwise to increase the value or anticlockwise to decrease it and press the knob to validate the selected digit.
  - c. Perform steps a. and b. again with the other digits to modify.

- d. Turn the rotary knob clockwise to put the cursor under **ENTER** and press the knob to validate the new wavelength value.

The **Unit Setup** menu is automatically displayed and the wavelength/frequency value of the module is now modified (according to the module limits).

## 11.7.2 Step-adjusting the Wavelength/Frequency Value of the Module

### Subject

The following procedure explains how to modify the wavelength/frequency of the module step by step using the increment defined in the **Set Step** sub-menu.

You can define a valid step value within the range 00.00–50.00 nm. If you use two non-adjacent T100, check that the step is high enough.

The starting wavelength is the value originally defined in the **Set  $\lambda$ /f** menu (see section *Specifying the Optical Emission Wavelength/Frequency*, p. 129).

### Procedure

1. Access the SWT APC **Unit Setup** menu (see section *Accessing an OSICS Module Setup Menu*, p. 33).

2. Expand the **Step** menu and enter the **Set Step** sub-menu.

The **Set Step** sub-menu appears and displays the current value of the wavelength/frequency step in nm or GHz .

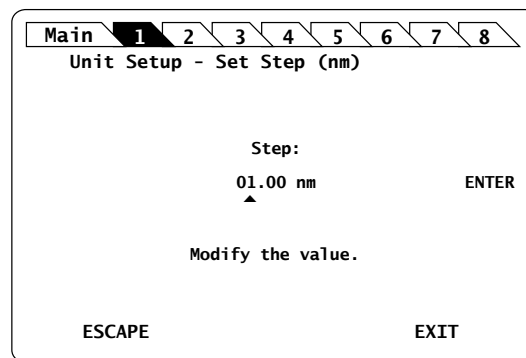

Figure 91: SWT APC Unit Setup – Set Step sub-menu

3. Modify the step value as follows:
  - a. Turn the rotary knob to put the cursor under the digit you want to modify and press the knob to highlight it.
  - b. Turn the knob clockwise to increase the value or anticlockwise to decrease it and press the knob to validate the selected digit.
  - c. Perform steps a. and b. again with the other digits to modify.
  - d. Turn the rotary knob clockwise to put the cursor under **ENTER** and press the knob to validate the new wavelength value.

The **Unit Setup** menu is automatically displayed.

4. To increase or decrease the wavelength/frequency value defined in the **Set  $\lambda$ /f** menu (see section *Specifying the Optical Emission Wavelength/Frequency*, p. 129) step by step, expand the **Step** menu and put the cursor before the **Step +** or **Step -** sub-menus and press the knob to step-adjust the value.

While the module is updating the wavelength/frequency, the message **Moving...** appears along with the new wavelength/frequency value after step-change.

5. Repeat step 4. until the wanted wavelength/frequency is reached.

## 11.7.3 Scanning a Predefined Wavelength/Frequency Range

### Subject

The **Scan** function enables you to scan a predefined wavelength range step-by-step, using the channel increment defined in the **Step** sub-menu to directly set the emission wavelength (or optical frequency) of the SWT APC tunable laser.

Starting from the first wavelength (the lower wavelength limit you have set), the emission wavelength increases incrementally (the wavelength increment is stored in the **Step** parameter) up to the last wavelength value (the upper wavelength limit you have set). During each scan interval, the OSICS T100 laser driven by the OSICS SWT APC module scans at a selected wavelength range for the duration specified by the **Delay** parameter.

### 11.7.3.1 Setting the Scan Parameters

#### Subject

This section explains how to configure the scan mode by setting the following parameters:

- The first and last wavelength/frequency of the scan
- The value of the wavelength/frequency step that is used in the scan
- The time between steps
- The number of cycles of the scan

#### Before Starting

- Set the SWT APC to **Full-Band** mode (see section *Selecting the Operating Mode*, p. 122) and specify the connected modules (section *Configuring the Full-Band Mode*, p. 124).

#### Procedure

1. Access the SWT APC **Unit Setup** menu (see section *Accessing an OSICS Module Setup Menu*, p. 33).
2. Expand the **Scan** menu and enter the wanted setting menus:
  - **$\lambda/f$  start** sub-menu: to select the first wavelength/frequency of the scan.
  - **$\lambda/f$  end** sub-menu: to select the last wavelength/frequency of the scan.
  - **Step** sub-menu: to select the value of the wavelength/frequency step that you want to use for the scan.
  - **Delay** sub-menu: to select the duration of a scan step.
  - **Scan Number** sub-menu: to select the number of scan cycles. If you select 0000, the OSICS SWT APC will scan indefinitely.

The sub-menu appears and displays the value of the corresponding scan parameter.

3. Modify the value as follows:
  - a. Turn the rotary knob to put the cursor under the digit you want to modify and press the knob to highlight it.
  - b. Turn the knob clockwise to increase the value or anticlockwise to decrease it and press the knob to validate the selected digit.
  - c. Perform steps a. and b. again with the other digits to modify.
  - d. Turn the rotary knob clockwise to put the cursor under **ENTER** and press the knob to validate the new value.

The SWT APC **Unit Setup** menu is automatically displayed and the scan parameters are set.

### 11.7.3.2 Controlling the Scan

**Subject** This section explains how to start, stop and resume the scan.

- Before Starting**
- Configure the scan parameters as explained in section *Setting the Scan Parameters*, p. 131.
  - Set the optical output power of the SWT APC module (see section *Setting the Optical Output Power of the SWT APC Module (Full-Band Mode)*, p. 128).
  - Set the SWT APC to **Full-Band** mode (see section *Selecting the Operating Mode*, p. 122) and specify the connected modules (section *Configuring the Full-Band Mode*, p. 124).

**Procedures**

**Starting/Stopping a New Scan**

1. Access the SWT APC **Unit Setup** menu (see section *Accessing an OSICS Module Setup Menu*, p. 33).
2. Expand the **Scan** menu and enter the **Control** sub-menu.

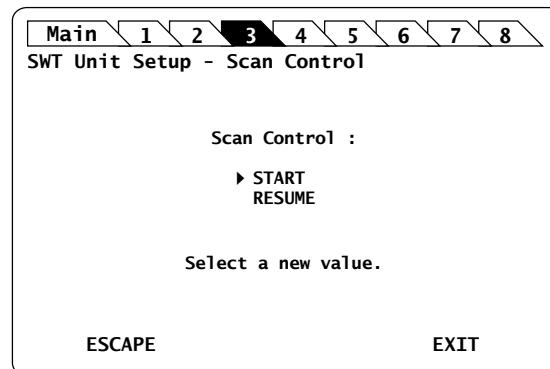

Figure 92: SWT APC Unit Setup – Scan Control sub-menu

3. Turn the rotary knob to put the cursor before **START** and press it to validate your selection.  
The **Scan** sub-menu appears and displays real-time information on the scanning process.
4. To stop the scan, press the **ESCAPE** control button.

**Resuming the Scan**

1. Access the SWT APC **Unit Setup** menu (see section *Accessing an OSICS Module Setup Menu*, p. 33).
2. Expand the **Scan** menu and enter the **Control** sub-menu.
3. Turn the rotary knob to put the cursor before **RESUME** and press it to validate your selection.  
The **Scan** sub-menu appears and displays real-time information on the scanning process.

## 11.8 Activating Coherence Control on all Connected T100 Modules (Full-Band Mode)

**Subject** The OSICS SWT APC module enables you to control the Coherence Control function of all the connected T100 modules.

The Coherence Control function induces broadening of the OSICS T100 tunable laser linewidth. This feature is especially useful in helping reduce interferometric noise. Coherence control consists in modulating the frequency with a pseudo-noise signal that widens the OSICS T100 optical signal linewidth. The specified linewidth for the OSICS T100 module is 150 kHz (typical value) as indicated in the module specifications without coherence control. This linewidth is brought to 100 MHz when the coherence control function is on.

The OSICS T100 module feature a built-in modulation source used to implement coherence control function on-board. You do not need to connect any external modulation device to the OSICS system.

The following procedure explains how to activate the coherence control function to produce the linewidth broadening required.

**Before Starting**

- Set the SWT APC to **Full-Band** mode (see section *Selecting the Operating Mode*, p. 122) and specify the connected modules (section *Configuring the Full-Band Mode*, p. 124).

**Procedure**

- Access the SWT APC **Unit Setup** menu (see section *Accessing an OSICS Module Setup Menu*, p. 33).
- Turn the rotary knob to put the cursor before the **Coherence** menu and press the knob.

The **Coherence** menu appears and the cursor points to the current setting.

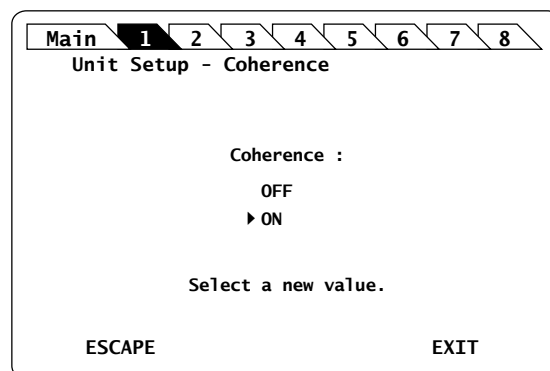

Figure 93: SWT APC Unit Setup – Coherence Control menu

- Turn the rotary knob to put the cursor before the wanted setting, and press it to validate your selection.

The new state of the coherence control function is implemented immediately in all the T100 modules connected to the SWT APC. The **Unit Setup** menu is automatically displayed.

In the OSICS **System Status** screen, the message **C** is displayed in the OSICS module channel **Info** field if the coherence control function is currently enabled on this module.

## 11.9 Activating the Auto-peak Find Function (Full-Band Mode)

**Subject** The OSICS SWT APC module enables you to activate the Auto-peak find function for all the connected T100 modules.

The **Auto peak find** function generates current pulses in order to stabilize the cavity operating conditions and stabilize the linewidth.

When implemented, the **Auto peak find** function generates a small power fluctuation during a brief instant that may disrupt certain applications.

If enabled, the **Auto-peak Find** is performed 1 second immediately after the laser output is enabled and then every 10 minutes afterward.

**Before Starting**

- Set the SWT APC to **Full-Band** mode (see section *Selecting the Operating Mode*, p. 122) and specify the connected modules (section *Configuring the Full-Band Mode*, p. 124).

**Procedure**

- Access the SWT APC **Unit Setup** menu (see section *Accessing an OSICS Module Setup Menu*, p. 33).
- Turn the rotary knob to put the cursor before the **Auto peak find** menu and press the knob.

The **Auto peak find** menu appears and the cursor points to the current setting.

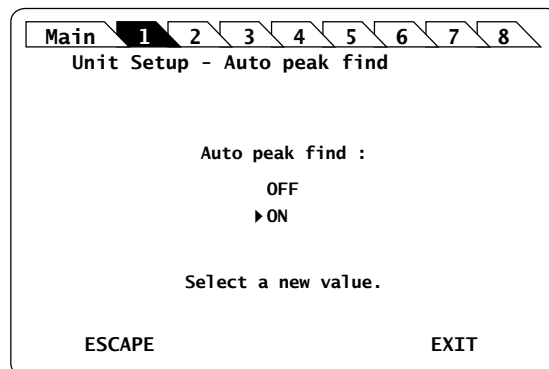

Figure 94: SWT APC Unit Setup – Auto peak find menu

- Turn the rotary knob to put the cursor before the wanted setting, and press it to validate your selection.

The new state is implemented immediately on all the T100 modules connected to the SWT APC. The **Unit Setup** menu is automatically displayed.

In the OSICS **System Status** screen, the message **A** is displayed in the OSICS module channel **Info** field if the Auto peak find function is currently enabled on this module.

## 11.10 Configuring the Modulation for All Connected T100 Modules (Full-Band Mode)

- Subject** The modulation is a typical function of OSICS T100 modules. For more details on the modulation of this module, see section *Using the OSICS T100 Module*, p. 141. From the OSICS SWT APC, you can configure the modulation for all connected T100 modules:
- To define the modulation source for all connected T100 modules, see section *Defining the Modulation Source for All Connected T100 Modules*, p. 135.
  - To control the modulation of all connected T100 modules, see section *Controlling the Modulation of All Connected T100 Modules*, p. 136.
- Before Starting**
- Set the SWT APC to **Full-Band** mode (see section *Selecting the Operating Mode*, p. 122) and specify the connected modules (section *Configuring the Full-Band Mode*, p. 124).

### 11.10.1 Defining the Modulation Source for All Connected T100 Modules

- Subject** The following section explains how to configure the wanted modulation source for all T100 modules connected to the OSICS SWT APC. The SWT APC has no internal modulation source, so if you set the modulation source to **INTERNAL**, the internal modulation source of the corresponding T100 module will be used for modulation.

- Procedure**
1. Access the SWT APC **Unit Setup** menu (see section *Accessing an OSICS Module Setup Menu*, p. 33).
  2. Expand the **Modulation** menu and enter the **Source** sub-menu.

The **Modulation Source** sub-menu appears and displays the current selected modulation source.

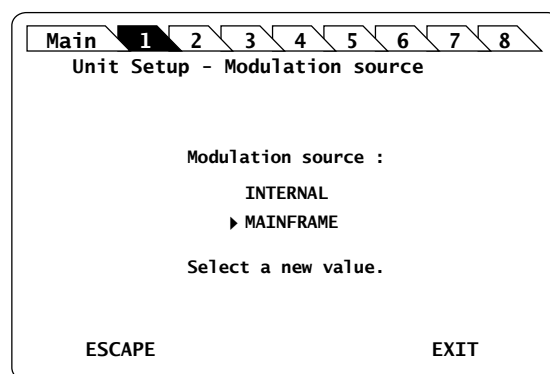

Figure 95: SWT APC Unit Setup – Modulation Source

3. Turn the rotary knob to put the cursor before the wanted modulation source and press it to validate your selection.
  - **INTERNAL** designates the internal modulation source of the T100 modules.
  - **MAINFRAME** designates the OSICS Mainframe modulation source, which can be internal or external.

The SWT APC **Unit Setup** menu is automatically displayed and the modulation source is set for all the T100 modules connected to the SWT APC.

- If you have selected INTERNAL, set the frequency of the individual T100 modules using the **Set Frequency** sub-menu of the module setup menus (as explained in the corresponding module section).
- If you have selected MAINFRAME, configure the wanted mainframe modulation as explained in the T100 module section.

## 11.10.2 Controlling the Modulation of All Connected T100 Modules

- Subject** From the OSICS SWT APC, you can control the modulation of all T100 modules connected to the SWT APC. To achieve this, the modulation source and frequency must be set for all modules.
- Before Starting**
- Set the wanted modulation source for all T100 modules connected to the SWT APC, as explained in section *Defining the Modulation Source for All Connected T100 Modules*, p. 135, or directly from the setup menu of the modules.
  - Set the wanted modulation frequency for each connected module using the **Set Frequency** sub-menu of the module **Unit Setup** menu or of the OSICS Mainframe **Main Setup** menu, depending on the selected modulation source.
- Procedure**
1. Access the SWT APC **Unit Setup** menu (see section *Accessing an OSICS Module Setup Menu*, p. 33).
  2. Expand the **Modulation** menu and enter the **Control** sub-menu.  
The **Modulation control** sub-menu appears and displays the current state of the modulation control.

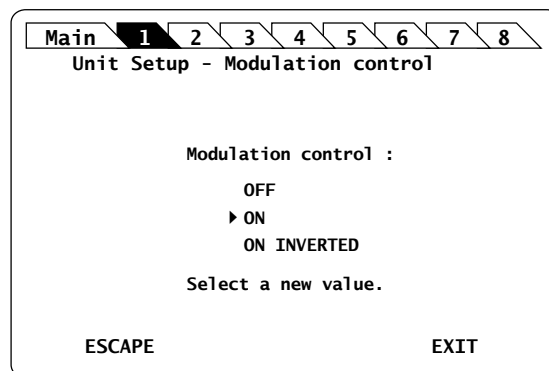

Figure 96: SWT APC Unit Setup – Modulation Control (On)

3. Turn the rotary knob to put the cursor before the wanted modulation:
  - **ON** for standard modulation.
  - **ON INVERTED** for reverse modulation
4. Press the rotary knob to validate your selection.

Modulation is enabled. In the **System Status** screen, the letter **M** is displayed in the channel **Info** field of the corresponding modules.

5. To stop the modulation: in the **Control** sub-menu, select **OFF**.



## 11.11 Monitoring the Optical Output Power of the SWT APC Module

### Subject

The OSICS Mainframe rear panel (see *Figure 2, p. 18*) features eight channel ports, each of them is dedicated to a specific channel-slot and identified by its channel number (CH1 to CH8). As they are numbered from left to right, channel ports do not face across their corresponding slots.

The channel port **OUT 1** of the SWT APC provides an analog signal that you can use to monitor the module output power in real time.

The **OUT 1** voltage is electronically linked to the photodiode transimpedance amplifier (not generated by software); so the signal level depends on the photodiode spectral sensitivity and the insertion loss of internal components: at constant power, the **OUT 1** signal level depends on wavelength (see *Figure 97, p. 137* below).

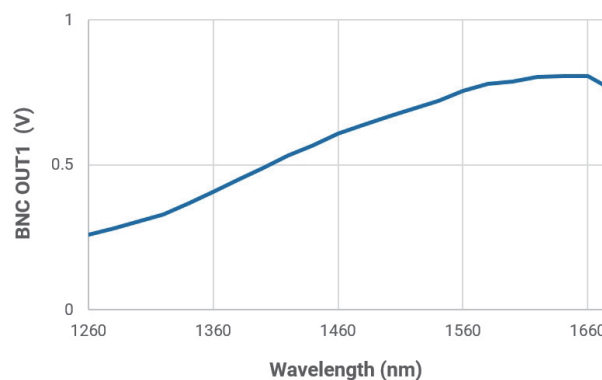

Figure 97: BNC OUT1 signal level depending on wavelength (at 2 mW)

### Before Starting

Make sure you have a voltmeter.

### Procedure

1. Enable the light source of all connected modules as described in section *Enabling/Disabling the Light Source of all Connected Modules (Full-Band Mode)*, p. 127.
2. To monitor the selected signal, connect your voltmeter to the **OUT 1** BNC connector corresponding to the channel slot number of the SWT APC module.

## 11.12 Testing the Performance of the SWT APC Module

Use the procedures described in this section to validate warranted specifications of the OSICS SWT APC module, as needed.

### 11.12.1 Preparing Performance Tests

**Before Starting** Make sure you have the following required equipment for conducting performance tests on OSICS SWT APC modules:

Equipment	Minimum Requirement
Optical power meter (x2)	Wavelength range: 1250 nm to 1650 nm Resolution: < 0.001 dB Dynamic range: > 70 dB
Laser source	Wavelength range: 1250 to 1650 nm
Fiber optic coupler	FC/APC connectors

The various types as well as the number of fiber-optic connectors needed may vary depending on the type of equipment used and the distance between the test equipment and the OSICS SWT APC modular optical source under test.



#### Warning

- Disable the laser output before connecting or disconnecting a fiber optic cable on the module (see section *Enabling/Disabling the Light Source of All Modules*, p. 37).
- Do not look directly into the fiber end of an optical cable connected to any optical output while the device is in use. This may cause permanent eye damage.

#### Procedure

1. In the OSICS Mainframe, install the SWT APC modules you want to test.
2. Turn-on the OSICS multifunction platform (see section *Turning on the OSICS Multifunction Platform and Accessing the System Status Screen*, p. 29).
3. Let the OSICS multifunction platform and other test equipments run continuously for 2 hours at room temperature (within the specified operating temperature range) to achieve proper equipment warm-up.

## 11.12.2 Verifying the Repeatability

### Subject

This procedure verifies that the SWT APC module repeatability is within specification range over 100 measurements for each channel.

The following figure illustrates the appropriate setup to perform the repeatability test:

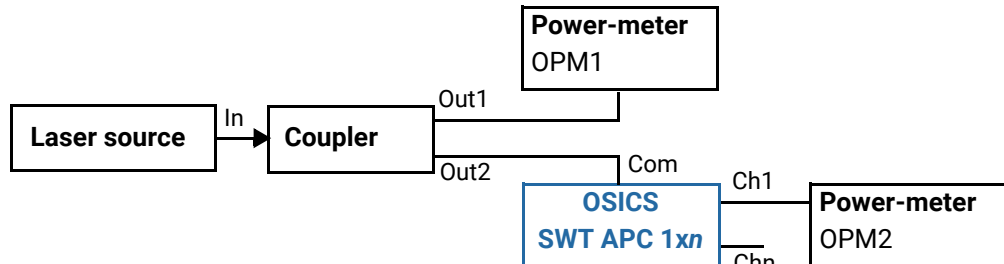

Figure 98: SWT APC Performance Test – Repeatability

### Before Starting

Make sure you have the appropriate power-meter (see section *Preparing Performance Tests*, p. 138).

### Procedure

1. Disable all laser source outputs and other modules in the OSICS Mainframe.
2. Connect the measurement equipments as indicated on *Figure 98*, p. 139.
3. If you are using an OSICS T100 or OSICS DFB as the external source, enable the laser output.
4. Enable the output channel under test (in our example **Ch1**) and record the power output value P1 and P2 provided respectively by OPM1 and OPM2 after the power reading has stabilized.
5. Select dBm as the power-meter measurement unit and hold the range on OPM2 for better accuracy.
6. Turn off and on Ch1 for 100 times, and record each time the power reading P1 and P2 (in dBm) on both power-meters OPM1 and OPM2.
7. Subtract OPM2 reading from OPM1 reading ( $P1-P2$ ) for each of the 100 measurements and record the result.
8. Find the maximum ( $|P1-P2|_{\max}$ ) and minimum ( $|P1-P2|_{\min}$ ) values among the  $|P1-P2|$  records calculated in step 6. above.
9. Subtract the maximum and minimum values to get the module repeatability.
10. Verify that the calculated repeatability value is within the specification range of 0.02 dB.
11. Perform the same operations for the second OSICS SWT APC module channel.

### 11.12.3 Verifying the Crosstalk

**Subject** The following figure illustrates the appropriate setup to perform the crosstalk test:



Figure 99: SWT APC Performance Test – Crosstalk

**Before Starting** Make sure you have the appropriate power-meter (see section *Preparing Performance Tests*, p. 138).

- Procedure**
1. Disable all laser source outputs and other modules in the OSICS Mainframe.
  2. Connect the measurement equipments as indicated on *Figure 99*, p. 140.
  3. Select dBm as the power-meter unit.
  4. Select the channel (Ch1 in our example) that you want to measure.
  5. Record the power value provided by the power-meter.
  6. Switch the laser signal to another channel, while the power-meter is still measuring Ch1.
  7. Record the power on the power-meter.
  8. Subtract the second power from the first measure to get the crosstalk.
  9. Verify that the calculated value is over the specified value of 50 dB.
  10. Perform the same operation for the Chn SWT APC channel.

## 12. Using the OSICS T100 Module

This section explains how to operate the OSICS T100 via the T100 **Unit Setup** menu. For more details on how to install and initialize the module into the OSICS Mainframe, see section *Installing and Connecting the OSICS Multifunction Platform*, p. 21.

### 12.1 OSICS T100 Presentation

The OSICS T100 is a tunable external cavity laser in a pluggable module utilizing patented T100 cavity. The optical layout of the cavity conforms to a modified Sagnac interferometer configuration. A beam-separator is placed right outside the path of laser-diode emission. Within the cavity, a double-pass reflection on the grating provides maximum dispersion, while the very short cavity, which maximizes mode spacing, yields a spectrally pure and truly single-mode operation.

#### 12.1.1 OSICS T100 Technical Specifications

		T100 1310	T100 1415	T100 1520	T100 1550	T100 1575	T100 1620
Wavelength Range (nm)	P = 3 dBm	1260– 1360	1360– 1470	1465– 1575	1490– 1610	1520– 1630	1560– 1680
	P = 6 dBm	1290– 1340	1390– 1445	1495– 1555	1520– 1590	1540– 1610	1580– 1660
Wavelength Setting Accuracy <sup>*5</sup>		±0.2 nm					
Wavelength Setting Resolution		0.01 nm (0.001 nm option R)					
Wavelength Stability <sup>*1</sup>		±0.01 nm/h (±0.01 nm / 24 h typical)					
Wavelength Setting Repeatability		±0.01 nm typical					
Tuning Speed (step-by step) <sup>*2*3</sup>		10 nm/s typical					
<b>Laser Output Characteristics</b>							
SSSER		> 90 dB / 0.1 nm typical					
SMSR <sup>*4</sup>		≥ 45 dB					
Output Power Stability <sup>*5</sup>		±0.01 dB/h (±0.01 dB / 24 h typical)					
Relative Intensity Noise <sup>*6</sup>		<-140 dB/Hz					
Spectral Width (FWHM)		150 kHz typical (coherence control off)					
		> 100 MHz (coherence control on)					
Laser Safety Classification		Class 1M					
<b>Interfaces</b>							
Analog Modulation		50 Hz to 50 MHz (external)					

	T100 1310	T100 1415	T100 1520	T100 1550	T100 1575	T100 1620
Digital Modulation	50 Hz to 1 MHz (internal & external)					
Output Fiber Type	SMF or PMF (option M)					
Output Connector	FC/APC narrow key					
<b>Physical Specifications</b>						
Dimensions (W x H x D)	35 mm (1.4 in) x 128 mm (5.0 in) x 230 mm (9.0 in)					
Weight	1.07 kg (2.36 lb)					

All specifications are given after 60 minutes warm-up and apply for wavelengths not equal to any water absorption line.

- \*1: At constant temperature.
- \*2: With the high resolution option (R) the tuning speed is 2.5 nm/s typ.
- \*3: The kinematic chain of the laser does not allow for swept operation.
- \*4: Measured over a 0.1 nm bandwidth  $\pm 1$  nm from the signal.
- \*5: Measured at +3 dBm output power.
- \*6: RIN within the range 100 MHz–3 GHz measured at +3 dBm output power with RBW = 30 kHz.

#### Permissible Values

T100 Model	Maximum Power	Laser Diode Current Level
P= 3 dBm	2 mW	200 mA
P= 6 dBm	4 mW	200 mA

#### Absolute Maximum Ratings

Minimum output power	> 0.2 mW
Maximum output power	< 15 mW
Maximum current	200 mA

## 12.1.2 OSICS T100 Module Overview

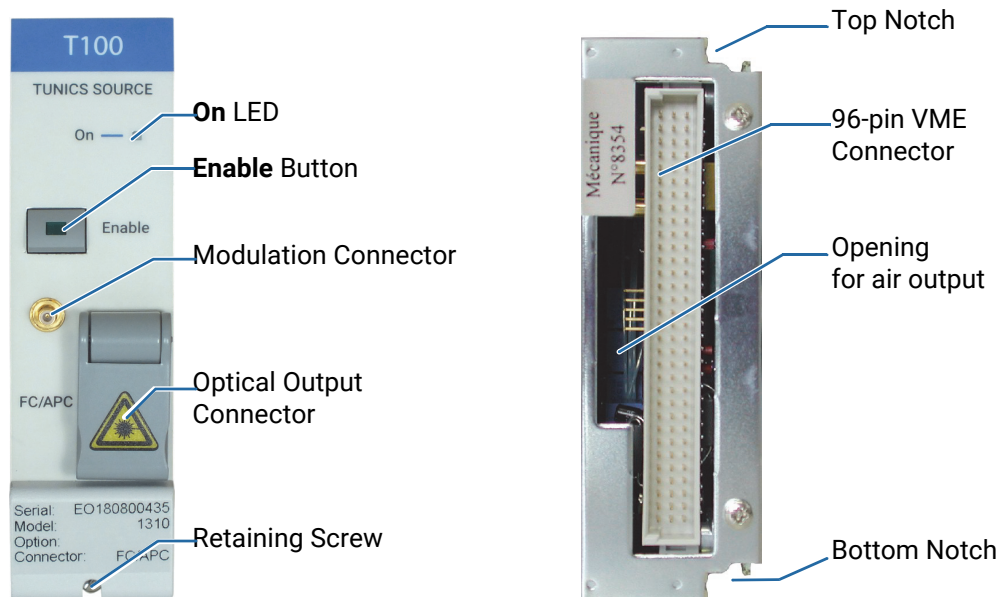

Figure 100: T100 Module – Front and Rear Panels

### Front Panel

#### On LED

This LED indicates that the module is turned on (see section *Turning on the OSICS Multifunction Platform and Accessing the System Status Screen*, p. 29).

#### Enable Button

This button enables you to turn on/off the laser inside the module. The green LED of the button is lit if the optical output is enabled, and the power value is displayed in the **System Status** screen (see section *System Status Screen Description*, p. 30).

#### Modulation Input Connector (Coaxial SMB type)

This connector enables you to directly modulate the laser diode chip of the module (see section *Setting Up Analog Modulation Using an External Source*, p. 161).

#### Optical Output Connector

The standard output connector is a FC/APC type connector.

For more details on the appropriate fiber type, see section *OSICS T100 Technical Specifications*, p. 141.

The  label located on the optical output connector cap indicates the location of the laser source.



#### Warning

Do not look directly into the fiber end of an optical cable connected to any optical output while the device is in use. This may cause permanent eye damage.

**Retaining Screw**

The captive screw enables you to lock/unlock the module inserted into the slot of the OSICS Mainframe.

**Caution**

The OSICS Mainframe does not support "hot-swap" of modules; for more details, see section *Handling OSICS Modules Into the OSICS Mainframe*, p. 23).

**Rear Panel****Notches**

The top and bottom notches enable you to slide the module into the OSICS Mainframe slot (see section *Installing an OSICS Module Into the OSICS Mainframe*, p. 23).

**96-pin VME Connector**

The rear panel of the OSICS modules interfaces with the OSICS Mainframe backplane by means of the 96-pin VME connector.

**Opening**

The opening ensures proper flow of cooled air drawn from the OSICS Mainframe chassis.

**Side Panel**

The labels affixed on the side panel of the OSICS T100 are described in section *OSICS Information and Warning Markings*, p. 19.



## 12.2 Enabling/Disabling the Light Source of the Module

### Subject

You can enable/disable the light source in two different ways:

- From the OSICS Mainframe **Main Setup** menu (see section *Enabling/Disabling the Light Source of All Modules, p. 37*), you can simultaneously enable or disable the light source in all the modules installed in the OSICS Mainframe. This function overrides the enable/disable state individually set in all modules.
- From the T100 front panel, you can individually enable or disable the light source of the module by using the **Enable** button as explained in the following procedure. This action does not affect the enable/disable state of other modules installed in the OSICS Mainframe.

For laser safety reasons, the light source in modules are disabled after OSICS initialization.

### Before Starting

Connect an optical device to the OSICS module (see section *Connecting Optical Devices to OSICS Modules, p. 26*).



#### Warning

- Do not enable the laser while there is no fiber connected to the optical output connector.
- Do not look directly into the fiber end of an optical cable connected to any optical output while the device is in use. This may cause permanent eye damage.

### Procedures

#### Enabling the Light Source of the Module

- On the T100 module front panel press the **Enable** button.

The green LED on the button is lit.

In the **System Status** screen, the output power is displayed in the **P** field (in dBm or mW depending on the selected power unit) for the corresponding module.

#### Disabling the Light Source of the Module

- On the T100 module front panel press the **Enable** button.

The green LED on the button is turned off.

In the **System Status** screen, the message **Disabled** is displayed for the corresponding module.

## 12.3 Setting the Optical Output Power of the T100 Module

### 12.3.1 Specifying the Optical Output Power of the Module

#### Subject

You can set the optical output power in two different ways:

- From the OSICS Mainframe **Main Setup** menu, you can simultaneously set the optical power of all modules to the same value: see section *Setting the Optical Output Power of All Installed Modules*, p. 38.
- From the T100 **Unit Setup** menu, you can set the output power of the module individually as explained in the following procedure.

The power value is software-limited to stay within the specified range.

#### Before Starting

- Set the optical power unit from the OSICS Mainframe **Main Setup** menu (see section *Selecting the Power Unit for All Installed Modules*, p. 38). You cannot set the power unit of an individual module.

#### Procedure

1. Access the T100 **Unit Setup** menu (see section *Accessing an OSICS Module Setup Menu*, p. 33).
2. Turn the rotary knob to put the cursor before the **Set Power** menu and press the knob.

The **Set Power** menu appears and displays the current power setting.

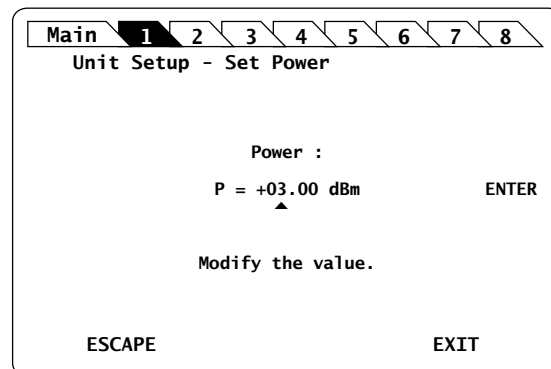

Figure 101: T100 Unit Setup – Set Power menu

3. Modify the power value as follows:
  - a. Turn the rotary knob to put the cursor under the digit of +/- sign you want to modify and press the knob to highlight it.
  - b. Turn the knob clockwise to increase the value or anticlockwise to decrease it and press the knob to validate the selected digit.
  - c. Perform steps a. and b. again with the other digits to modify.
  - d. Turn the rotary knob clockwise to put the cursor under **ENTER** and press the knob to validate the new power value.

The **Unit Setup** menu is automatically displayed and the optical power value of the module is now modified (according to the module power limits).

## 12.3.2 Performing Real-time Adjustments to the Output Power

- Subject** The following procedure explains how to adjust the output power of the module in real-time (within the accuracy determined by the smallest decimal-digit of the power value). The starting power is the value defined in the **Set Power** menu.
- Before Starting** Enable the optical output of the module (see section *Enabling/Disabling the Light Source of the Module*, p. 145).

- Procedure**
1. Access the T100 **Unit Setup** menu (see section *Accessing an OSICS Module Setup Menu*, p. 33).
  2. Turn the rotary knob to put the cursor before the **Adjust Power** menu and press the knob.

The **Adjust Power** menu appears and displays the current power setting, with the first digit highlighted.

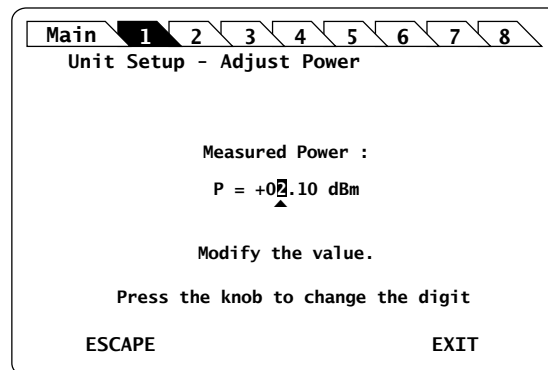

Figure 102: T100 Unit Setup – Adjust Power menu

3. Adjust the power value as follows:
  - a. Turn the knob clockwise to increase the digit value or anticlockwise to decrease it and press the knob to validate the selected digit. Rotating the knob increments or decrements the digit above the cursor. Going above "9" increases the next significant digit; going below "0" decreases the next significant digit.
  - b. Perform steps a. and b. again with the other digits to modify.

The module output power is updated in real time when you change the value in this menu.

4. Press one of the following control buttons:
  - **ESCAPE**: to validate the displayed value and go back to the T100 **Unit Setup** menu.
  - **EXIT**: to display the **System Status** screen.

The optical power value of the module is now modified (according to the module power limits).

## 12.4 Setting the Optical Emission Wavelength/Frequency

### 12.4.1 Specifying the Optical Emission Wavelength/Frequency

**Subject** The following procedure explains how to set the emission wavelength or optical frequency of the OSICS T100 module according to its specifications. Even though the module lets you set wavelength values outside this range, performance of your module is guaranteed only within the wavelength range established by the module specifications.

**Before Starting**

- Set the spectral unit from the OSICS Mainframe **Main Setup** menu (see section *Selecting the Spectral Unit for all Installed Modules*, p. 39). You cannot set the spectral unit of an individual module.

**Procedure**

- Access the T100 **Unit Setup** menu (see section *Accessing an OSICS Module Setup Menu*, p. 33).
- Turn the rotary knob to put the cursor before the **Set  $\lambda$ /f** menu and press the knob. The **Set Wavelength** menu appears and displays the emission wavelength or frequency.

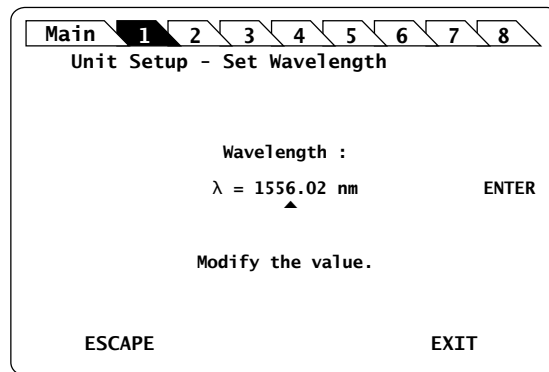

Figure 103: T100 Unit Setup – Set Wavelength/Frequency menu

- Modify the wavelength/frequency value as follows:
  - Turn the rotary knob to put the cursor under the digit you want to modify and press the knob to highlight it.
  - Turn the knob clockwise to increase the value or anticlockwise to decrease it and press the knob to validate the selected digit.
  - Perform steps a. and b. again with the other digits to modify.
  - Turn the rotary knob clockwise to put the cursor under **ENTER** and press the knob to validate the new wavelength value.

The **Unit Setup** menu is automatically displayed and the wavelength/frequency value of the module is now modified (according to the module limits).

## 12.4.2 Step-adjusting the Wavelength/Frequency Value of the Module

**Subject** The following procedure explains how to modify the wavelength/frequency of the module step by step using the increment defined in the **Set Step** sub-menu. You can define a valid step value within the range 00.00–50.00 nm. The starting wavelength is the value originally defined in the **Set  $\lambda$ f** menu (see section *Specifying the Optical Emission Wavelength/Frequency*, p. 148).

**Procedure**

1. Access the T100 **Unit Setup** menu (see section *Accessing an OSICS Module Setup Menu*, p. 33).
2. Expand the **Step** menu and enter the **Set Step** sub-menu.  
The **Set Step** sub-menu appears and displays the current value of the wavelength/frequency step in nm or GHz .

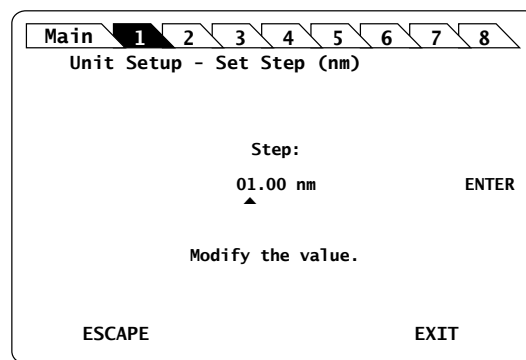

Figure 104: T100 Unit Setup – Set Step sub-menu

3. Modify the step value as follows:
  - a. Turn the rotary knob to put the cursor under the digit you want to modify and press the knob to highlight it.
  - b. Turn the knob clockwise to increase the value or anticlockwise to decrease it and press the knob to validate the selected digit.
  - c. Perform steps a. and b. again with the other digits to modify.
  - d. Turn the rotary knob clockwise to put the cursor under **ENTER** and press the knob to validate the new wavelength value.

The **Unit Setup** menu is automatically displayed.

4. To increase or decrease the wavelength/frequency value defined in the **Set  $\lambda$ f** menu (see section *Specifying the Optical Emission Wavelength/Frequency*, p. 148) step by step, expand the **Step** menu and put the cursor before the **Step +** or **Step -** sub-menus and press the knob to step-adjust the value.  
While the module is updating the wavelength/frequency, the message **Moving...** appears along with the new wavelength/frequency value after step-change.
5. Repeat step 4. until the wanted wavelength/frequency is reached.

## 12.5 Activating Coherence Control

**Subject** The Coherence Control function induces broadening of the OSICS T100 tunable laser linewidth. This feature is especially useful in helping reduce interferometric noise. Coherence control consists in modulating the frequency with a pseudo-noise signal that widens the OSICS T100 optical signal linewidth. The specified linewidth for the OSICS T100 module is 150 kHz (typical value) as indicated in the module specifications without coherence control. This linewidth is brought to 100 MHz when the coherence control function is on.

The OSICS T100 module features a built-in modulation source used to implement coherence control function on-board. You do not need to connect any external modulation device to the OSICS system.

The following procedure explains how to activate the coherence control function to produce the linewidth broadening required.

- Procedure**
1. Access the T100 **Unit Setup** menu (see section *Accessing an OSICS Module Setup Menu*, p. 33).
  2. Turn the rotary knob to put the cursor before the **Coherence** menu and press the knob.

The **Coherence** menu appears and the cursor points to the current setting.

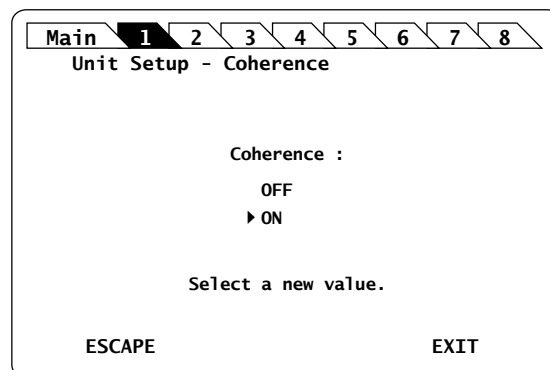

Figure 105: T100 Unit Setup – Coherence Control menu

3. Turn the rotary knob to put the cursor before the wanted setting, and press it to validate your selection.

The new state of the coherence control function is implemented immediately. The **Unit Setup** menu is automatically displayed.

In the OSICS **System Status** screen, the message **C** is displayed in the OSICS module channel **Info** field if the coherence control function is currently enabled on this module.

## 12.6 Activating the Auto-peak Find Function

### Subject

The **Auto peak find** function generates current pulses in order to stabilize the cavity operating conditions and stabilize the linewidth.

When implemented, the **Auto peak find** function generates a small power fluctuation during a brief instant that may disrupt certain applications.

If enabled, the **Auto-peak Find** is performed 1 second immediately after the laser output is enabled and then every 10 minutes afterward.

### Procedure

1. Access the T100 **Unit Setup** menu (see section *Accessing an OSICS Module Setup Menu*, p. 33).
2. Turn the rotary knob to put the cursor before the **Auto peak find** menu and press the knob.

The **Auto peak find** menu appears and the cursor points to the current setting.

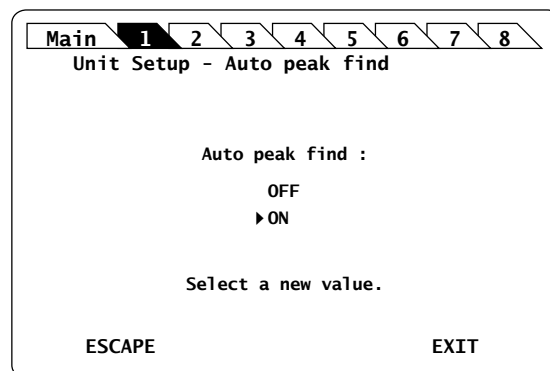

Figure 106: T100 Unit Setup – Auto peak find menu

3. Turn the rotary knob to put the cursor before the wanted setting, and press it to validate your selection.

The new state is implemented immediately. The **Unit Setup** menu is automatically displayed.

In the OSICS **System Status** screen, the message **A** is displayed in the OSICS module channel **Info** field if the Auto peak find function is currently enabled on this module.

## 12.7 Configuring the OSICS T100 Signal Modulation

**Presentation**

In addition to the OSICS Mainframe built-in modulation source (see section *Configuring the OSICS Mainframe Modulation*, p. 40), the OSICS T100 module holds a built-in digital modulation source.

The OSICS T100 module supports the following modulation schemes:

- Internal modulation:
  - Digital (TTL) modulation using the OSICS T100 internal source
  - Digital (TTL) modulation using the OSICS Mainframe internal source
- External modulation:
  - Digital (TTL) modulation using an external source connected to the OSICS Mainframe
  - Analog modulation using an external source connected to the OSICS T100

The **OUT 2** BNC connector can be used as an external modulation source for other devices.

**Modulation Scheme**

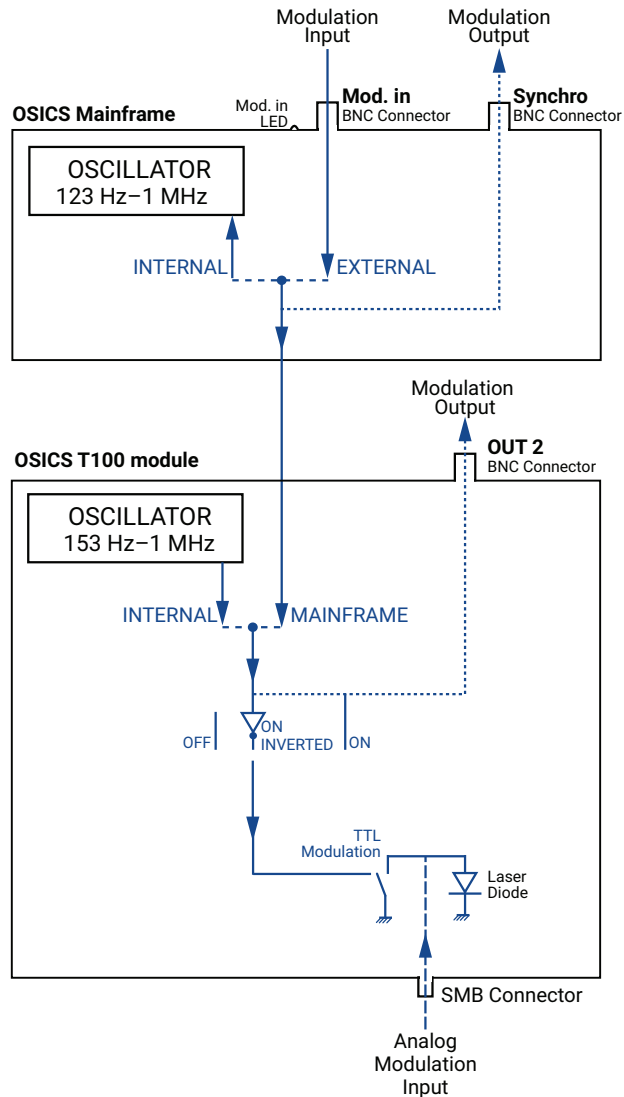

Figure 107: Mainframe and T100 Module Modulation Scheme



## 12.7.1 Setting Up Digital (TTL) Modulation Using the T100 Module Internal Source

### Subject

Digital modulation capabilities of the T100 module is within the 50 Hz–1 MHz frequency range (see the T100 specifications).

Internal digital modulation uses the T100 module's built-in TTL-level signal generator (see *Figure 107, p. 152*).

The T100 module's built-in TTL signal-generator can provide a TTL modulation signal in the range of 153 Hz–1 MHz, but for optimum modulation performance we recommend applying modulation frequencies within the specified range of the T100 module.

The resulting modulated optical output signal follows a pattern as shown in the following figure.

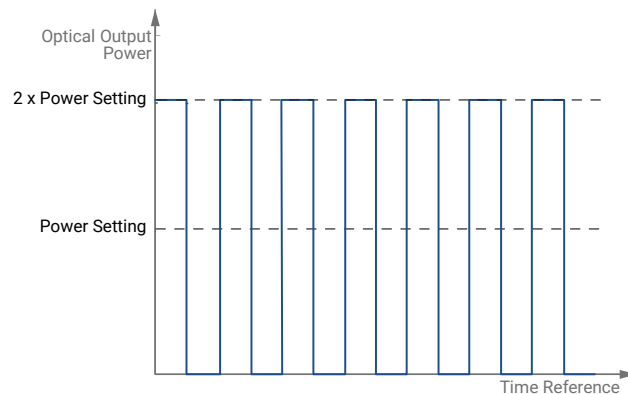

Figure 108: TTL-Modulated Output Power Signal (T100 Module)

### Procedure

#### Step 1 – Set the module modulation source to INTERNAL:

1. Access the T100 **Unit Setup** menu (see section *Accessing an OSICS Module Setup Menu, p. 33*).
2. Expand the **Modulation** menu and enter the **Source** sub-menu.

The **Modulation source** sub-menu appears and the cursor automatically points to the current modulation source setting.

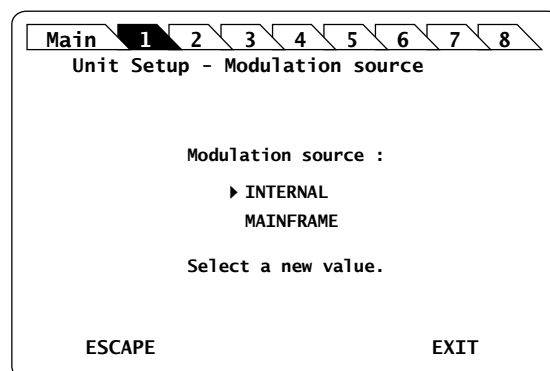

Figure 109: T100 Unit Setup – Modulation Source (Internal)

3. Turn the rotary knob to put the cursor before **INTERNAL** and press it to validate your selection.

The T100 **Unit Setup** menu is automatically displayed and the modulation is set to the selected source.

**Step 2 – Set the frequency of the module INTERNAL modulation source:**

1. In the T100 **Unit Setup** menu, expand the **Modulation** menu and enter the **Set Frequency** sub-menu.

The **Set Frequency** sub-menu appears and displays the current selected modulation frequency.

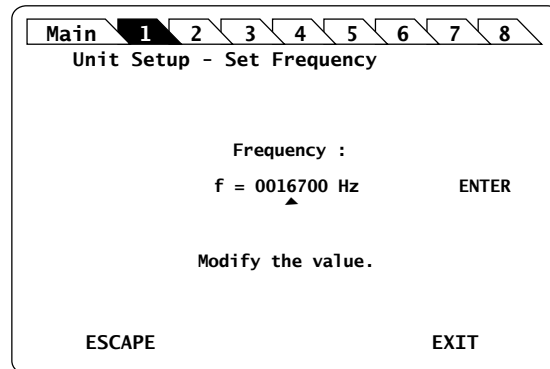

Figure 110: T100 Unit Setup – Set Frequency

2. Modify the frequency value as follows:

The T100 module's built-in TTL signal-generator can provide a TTL modulation signal in the range of 153 Hz–1 MHz, but for optimum modulation performance we recommend applying modulation frequencies within the specified range of the T100 module.

- a. Turn the rotary knob to put the cursor under the digit you want to modify and press the knob to highlight it.
- b. Turn the knob clockwise to increase the value or anticlockwise to decrease it and press the knob to validate the selected digit.
- c. Perform steps 1. and 2. again with the other digits to modify.
- d. Turn the rotary knob clockwise to put the cursor under **ENTER** and press the knob to validate the new frequency value.

The frequency is updated to the "real frequency". This screen displays the actual modulation frequency produced by the OSICS T100 oscillator, which may slightly differ from the values you have set.

3. Press the knob to validate the displayed real frequency.

**Step 3 – Set the modulation control:**

1. Access the T100 **Unit Setup** menu (see section *Accessing an OSICS Module Setup Menu*, p. 33).
2. Expand the **Modulation** menu and enter the **Control** sub-menu.

The **Modulation control** sub-menu appears and displays the current state of the modulation control.

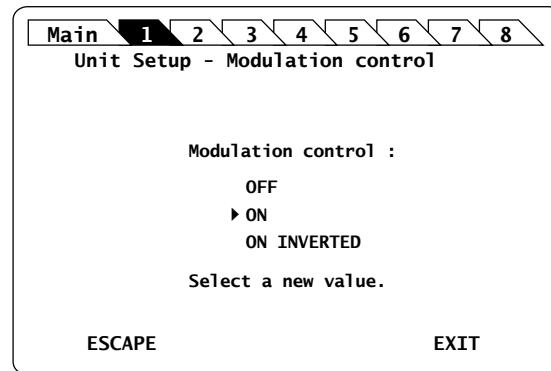

Figure 111: T100 Unit Setup – Modulation Control (On)

3. Turn the rotary knob to put the cursor before the wanted modulation:
  - **ON** for standard modulation.
  - **ON INVERTED** for reverse modulation
4. Press the rotary knob to validate your selection.

Modulation is enabled. In the **System Status** screen, the letter **M** is displayed in the channel **Info** field of the corresponding module.

5. To stop the modulation: in the **Control** sub-menu, select **OFF**.

## 12.7.2 Setting Up Digital (TTL) Modulation Using the Mainframe Internal Source

### Subject

This modulation setting uses the OSICS Mainframe's built-in internal oscillator as a source of TTL-level modulated signals (see *Figure 107, p. 152*). The main purpose of this setting is to provide simultaneous and synchronous modulation to several modules installed in the OSICS Mainframe, or to an external device connected to the OSICS Mainframe **Synchro** output connector.

The range of the frequency of the modulation provided by the OSICS Mainframe is defined to encompass the frequency requirements of all types of OSICS T100 modules. The frequency settings for the lower and upper bounds may therefore lie outside of the modulation capabilities of a particular module, in which case the module's own frequency range sets the modulation specifications.

The OSICS Mainframe signal generator can provide a TTL signal with a repetition frequency in the range 123 Hz–1 MHz, but for optimum modulation performance, we recommend applying modulation frequencies within the specified range of the T100 module.

The resulting signal-shape of the modulated output power is similar to the internally modulated pattern of the OSICS T100, as shown in *Figure 108, p. 153*.

### Procedure

#### Step 1 – Set the OSICS Mainframe modulation source to INTERNAL:

1. Access the **Main Setup** menu (see section *Accessing the OSICS Mainframe Main Setup Menu, p. 33*).
2. Enter the **Source** sub-menu as follows:

- a. Turn the rotary knob to put the cursor before the **Modulation** menu and press the knob to expand it.
- b. Turn the rotary knob to put the cursor before the **Source** sub-menu and press the knob to enter it.

The **Modulation Source** sub-menu appears and displays the current selected modulation source.

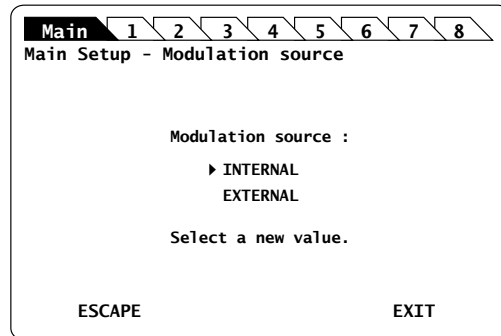

Figure 112: Main Setup – Modulation Source (Internal)

3. Turn the rotary knob to put the cursor before **INTERNAL** and press it to validate your selection.

The **Main Setup** menu is automatically displayed and the modulation is set to the selected source.

### Step 2 – Set the frequency of the OSICS Mainframe internal modulated-signal:

1. In the **Main Setup** menu, expand the **Modulation** menu and select the **Set frequency** sub-menu.

The **Modulation frequency** sub-menu appears and displays the current selected modulation frequency-value.

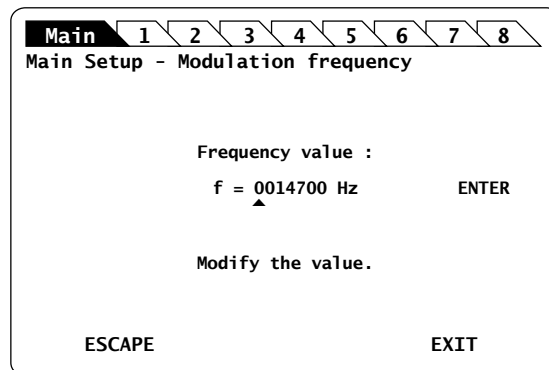

Figure 113: Main Setup – Modulation Frequency

2. Modify the frequency value as follows:

The internal TTL-signal generator can provide a TTL-modulated signal in the range 123 Hz to 1 MHz, but for optimum modulation performance we recommend applying modulation frequencies within the specified range of the T100 module.

- a. Turn the rotary knob to put the cursor under the digit you want to modify and press the knob to highlight it.
- b. Turn the knob clockwise to increase the value or anticlockwise to decrease it and press the knob to validate the selected digit.

- c. Perform steps a. and b. again with the other digits to modify.
- d. Turn the rotary knob clockwise to put the cursor under **ENTER** and press the knob to validate the new frequency value.

The frequency is updated to the "real frequency" as shown in *Figure 114, p. 157*. This screen displays the current modulation frequency produced by the OSICS Mainframe oscillator, which may slightly differ from the values you have set.

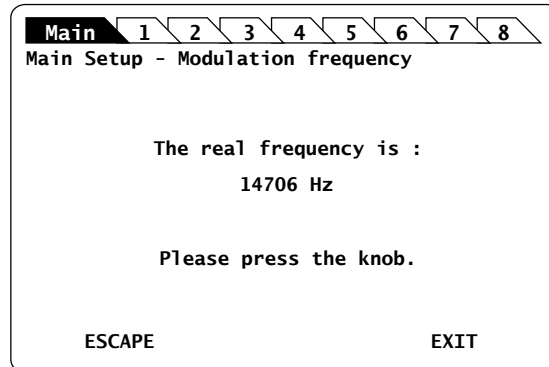

Figure 114: Main Setup – Modulation Real Frequency

3. Press the knob to go back to the **Main Setup** menu.

### Step 3 – Set the module modulation source to MAINFRAME:

1. Access the T100 **Unit Setup** menu (see section *Accessing an OSICS Module Setup Menu, p. 33*).
2. Expand the **Modulation** menu and enter the **Source** sub-menu.

The **Modulation source** sub-menu appears and the cursor automatically points to the current modulation source setting.

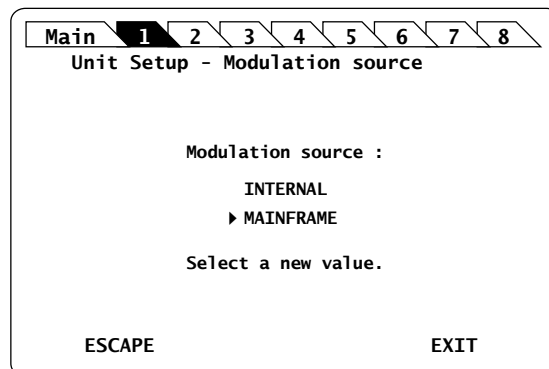

Figure 115: T100 Unit Setup – Modulation Source (Mainframe)

3. Turn the rotary knob to put the cursor before **MAINFRAME** and press it to validate your selection.

The T100 **Unit Setup** menu is automatically displayed and the modulation is set to the selected source.

### Step 4 – Set the modulation control:

1. Access the T100 **Unit Setup** menu (see section *Accessing an OSICS Module Setup Menu, p. 33*).

- Expand the **Modulation** menu and enter the **Control** sub-menu.

The **Modulation control** sub-menu appears and displays the current state of the modulation control.

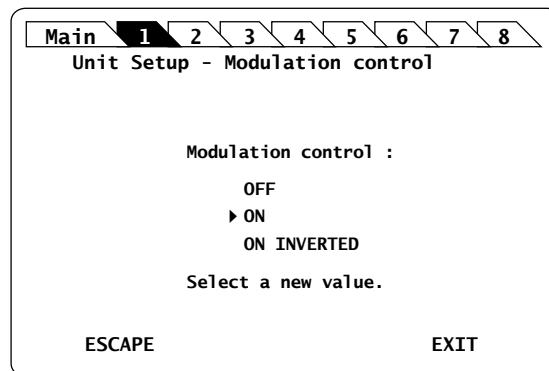

Figure 116: T100 Unit Setup – Modulation Control (On)

- Turn the rotary knob to put the cursor before the wanted modulation:

- **ON** for standard modulation.
- **ON INVERTED** for reverse modulation

- Press the rotary knob to validate your selection.

Modulation is enabled. In the **System Status** screen, the letter **M** is displayed in the channel **Info** field of the corresponding module.

- To stop the modulation: in the **Control** sub-menu, select **OFF**.

### 12.7.3 Setting Up Digital (TTL) Modulation Using an External Source

#### Subject

External digital-modulation is achieved by applying a digital signal to the BNC **Mod. In** connector located on the OSICS Mainframe rear panel (see *Figure 107, p. 152*). This allows all the modules (or an external device connected to the OSICS Mainframe **Synchro** output connector) to be modulated in a synchronous way by means of an external source. The OSICS Mainframe distributes the external modulated-signal to all installed modules in order to synchronize all modules with a single modulated signal, amplitude, and frequency.

For optimum stability of the modulated signals, we recommend applying a digital modulation in the specified range of the modules.

#### Before Starting

Make sure you have a digital-signal generator.

#### Procedure

##### Step 1 – Set the OSICS Mainframe modulation source to EXTERNAL:

- Access the **Main Setup** menu (see section *Accessing the OSICS Mainframe Main Setup Menu, p. 33*).
- Enter the **Source** sub-menu as follows:
  - Turn the rotary knob to put the cursor before the **Modulation** menu and press the knob to expand it.
  - Turn the rotary knob to put the cursor before the **Source** sub-menu and press the knob to enter it.

The **Modulation source** sub-menu appears and displays the current selected modulation source.

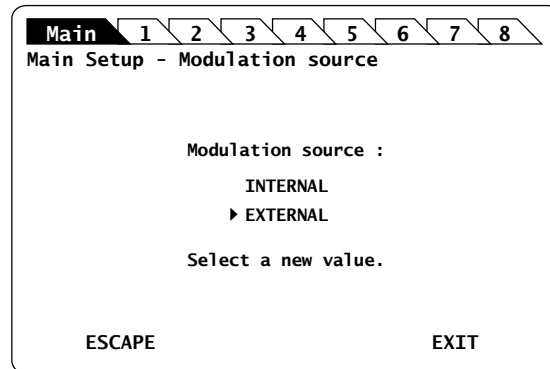

Figure 117: Main Setup – Modulation Source (External)

3. Turn the rotary knob to put the cursor before **EXTERNAL** and press it to validate your selection.

The **Main Setup** menu is automatically displayed and the modulation is set to the selected source.

### Step 2 – Set the TTL-level signal generator:

1. On the OSICS Mainframe rear panel, connect your external digital signal-generator to the **Mod. in** BNC connector (see *Figure 2, p. 18*).
2. Apply the TTL signal not exceeding the maximum voltage of +5 V and repetition frequency between 50 Hz and 1 MHz.

The green LED located next to the **Mod. In** connector is lit to indicate that an external signal-generator is connected.

### Step 3 – Set the module modulation source to MAINFRAME:

1. Access the T100 **Unit Setup** menu (see section *Accessing an OSICS Module Setup Menu, p. 33*).
2. Expand the **Modulation** menu and enter the **Source** sub-menu.

The **Modulation source** sub-menu appears and the cursor automatically points to the current modulation source setting.

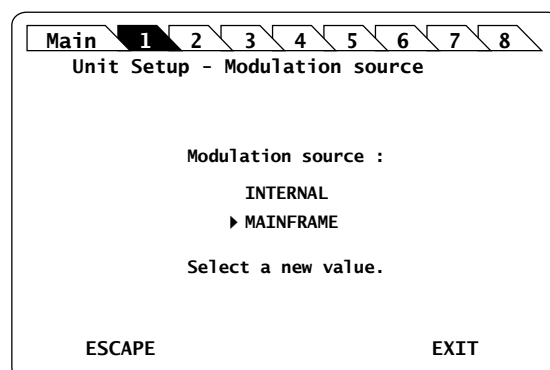

Figure 118: T100 Unit Setup – Modulation Source (Mainframe)

3. Turn the rotary knob to put the cursor before **MAINFRAME** and press it to validate your selection.

The T100 **Unit Setup** menu is automatically displayed and the modulation is set to the selected source.

#### Step 4 – Set the modulation control:

1. Access the T100 **Unit Setup** menu (see section *Accessing an OSICS Module Setup Menu*, p. 33).
2. Expand the **Modulation** menu and enter the **Control** sub-menu.

The **Modulation control** sub-menu appears and displays the current state of the modulation control.

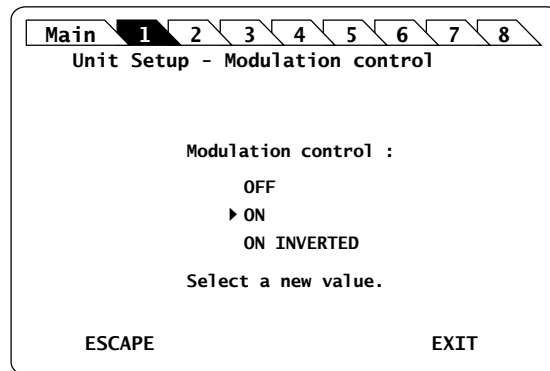

Figure 119: T100 Unit Setup – Modulation Control (On)

3. Turn the rotary knob to put the cursor before the wanted modulation:
  - **ON** for standard modulation.
  - **ON INVERTED** for reverse modulation
4. Press the rotary knob to validate your selection.

Modulation is enabled. In the **System Status** screen, the letter **M** is displayed in the channel **Info** field of the corresponding module.

5. To stop the modulation: in the **Control** sub-menu, select **OFF**.



## 12.7.4 Setting Up Analog Modulation Using an External Source

### Subject

The SMB connector located on the front panel of the T100 module is directly connected to the laser chip and allows you to couple an external modulating-current to the system bias current (see *Figure 107, p. 152*).

By modulating this external current, you can modulate the optical power output in a frequency range from 50 Hz to 50 MHz.

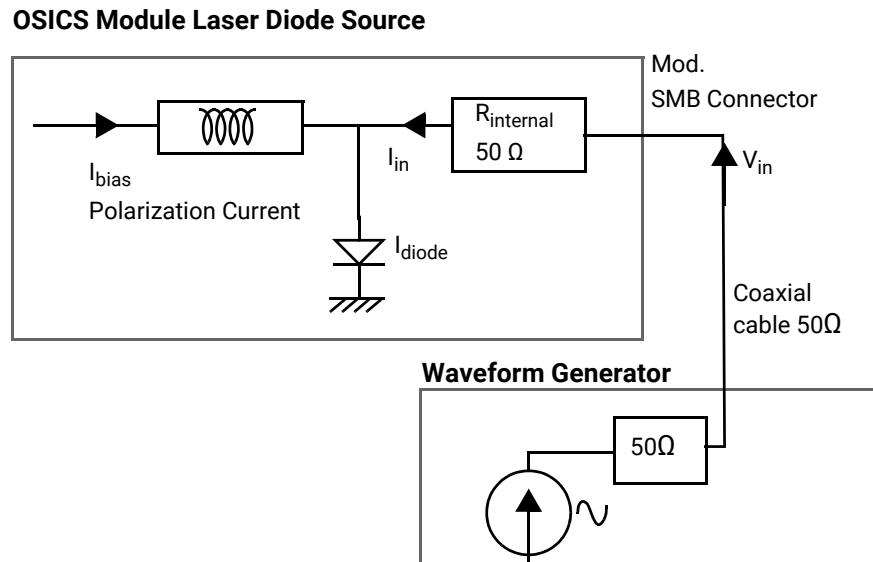

Figure 120: External Analog Modulation Setup

The relationship between the voltage applied at the SMB input and the current added to the diode is given by:  $I_{in} = V_{in}/R_{internal}$

where:

- $I_{in}$  is the added current
- $V_{in}$  is the voltage applied to the SMB input
- $R_{internal}$  is the 50  $\Omega$  internal impedance of your T100 module

TTL modulation can also be applied directly on the module's front panel using the input SMB connector generally used for the analog modulation. The modulation is applied directly on the laser chip. In this case, simultaneous modulation for all the modules is not possible.

Laser diode current level is available in section *OSICS T100 Technical Specifications, p. 141*.

### Before Starting

Make sure you have a 50  $\Omega$  coaxial cable to connect your HF-generator to the 50  $\Omega$  input SMB connector.



#### Caution

Before applying an external analog-modulation, make sure the modulation control is set to off.

### Procedure

1. Set the module modulation control to off as follows:

- a. Access the T100 **Unit Setup** menu (see section *Accessing an OSICS Module Setup Menu*, p. 33).
- b. Expand the **Modulation** menu and enter the **Control** sub-menu.

The **Modulation control** sub-menu appears and displays the current state of the modulation control.

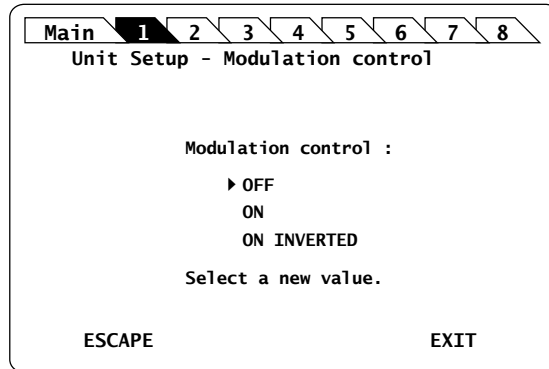

Figure 121: T100 Unit Setup – Modulation Control (Off)

- c. Turn the rotary knob to put the cursor before **OFF** and press it to validate your selection.

Modulation control is disabled and the T100 **Unit Setup** menu is displayed.

2. Connect your HF-generator to the 50  $\Omega$  input SMB connector using a 50  $\Omega$  coaxial cable.



#### Caution

The SMB input is directly connected to the laser diode chip via a 50  $\Omega$  resistor. It is essential to make sure that at all times the diode is forward-biased to avoid damage or possible destruction of the diode.

3. Since the SMB input is directly connected to the laser diode chip, make sure that the input voltage is such that the following conditions are always met:
  - The diode laser is forward-biased.
  - The current flowing through the diode is lower than the maximum allowed current ( $I_{max}$ ) indicated in the system acceptance test report.

The best way to fulfill the above conditions is to monitor the T100 module bias-current ( $I_{bias}$ ) via the rated output voltage measured at the **OUT 1** port located on the rear panel of the OSICS Mainframe (see *Figure 2*, p. 18), and to compute the total current using the following formula:

$$I_{diode} = I_{bias} + V_{in}/R_{internal}$$

Where:

- $I_{diode}$  is the total current through the diode
- $I_{bias}$  is the bias current
- $V_{in}$  is the voltage applied to the SMB input
- $R_{internal}$  is the 50  $\Omega$  internal impedance of the T100 module

You must monitor  $V_{in}$  to ensure that the total current remains positive and lower than the maximum allowed current ( $I_{max}$ ), as shown in the following figure:

$$0 < I_{diode} < I_{max}$$

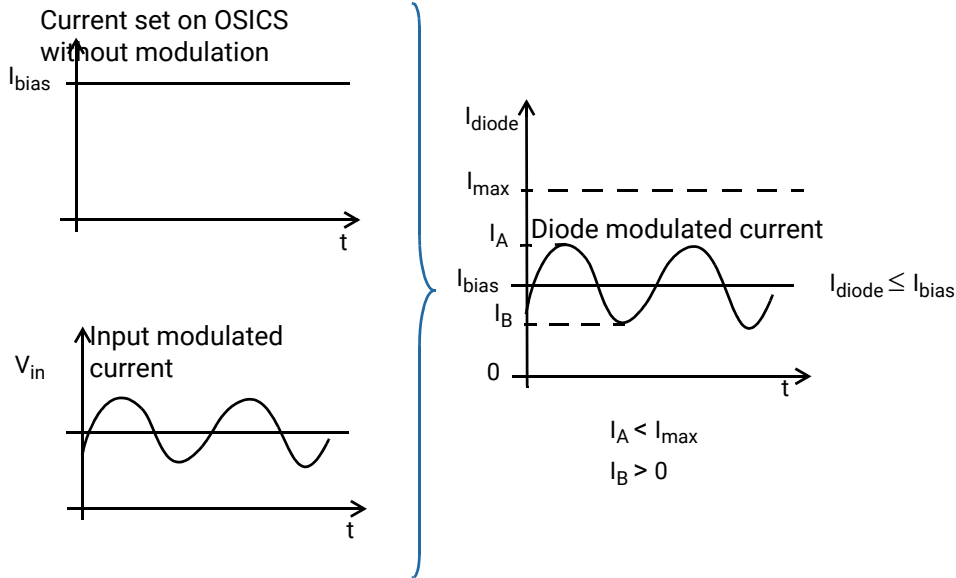

Figure 122: Resulting Diode Current with External Analog Modulation Source

If the voltage applied to the SMB input is an AC signal with no DC component and with peak-to-peak amplitude is  $V_{pp}$ , the above condition becomes:

$$V_{pp} < 2 \times R_{internal} (I_{max} - I_{bias})$$

$$V_{pp} < 2 \times R_{internal} (I_{bias})$$

## 12.7.5 Using the T100 Module as a Modulation Source for External Devices (OUT 2 Output)

### Subject

The OSICS Mainframe rear panel (see *Figure 2, p. 18*) features eight channel ports, each dedicated to a specific channel-slot and identified by its channel number (CH1 to CH8). As they are numbered from left to right, channel ports do not face across their corresponding slots.

Each channel can produce two types of output signals on BNC connectors:

- **OUT 1:** analog signal for constant monitoring of the laser diode current. For more details, see section *Monitoring the OSICS T100 Module Parameters Using the Analog OUT 1 Output, p. 165*.
- **OUT 2:** analog signal from the T100 module (see *Figure 107, p. 152*) that you can use as an external modulation source for other devices. The following procedure explains how to set the OUT 2 analog signal.

You can also use the OSICS Mainframe as a modulation source for external devices with the **Synchro** BNC output connector, as explained in section *Using the Mainframe as a Modulation Source for External Devices (Synchro Output), p. 44*.

### Procedure

1. Set up the wanted digital modulation to the T100 module using one of the following methods:
  - T100 module internal modulation source, as explained in section *Setting Up Digital (TTL) Modulation Using the T100 Module Internal Source, p. 153*.
  - OSICS Mainframe internal modulation source, as explained in section *Setting Up Digital (TTL) Modulation Using the Mainframe Internal Source, p. 155*.
  - OSICS Mainframe external modulation source, as explained in section *Setting Up Digital (TTL) Modulation Using an External Source, p. 158*.
2. Connect the wanted appropriate device to the **OUT 2** BNC connector corresponding to the channel slot number of the module.

The selected modulation frequency is applied to the connected device.

## 12.8 Monitoring the OSICS T100 Module Parameters Using the Analog OUT 1 Output

**Subject** The OSICS Mainframe rear panel (see *Figure 2, p. 18*) features eight channel ports, each of them is dedicated to a specific channel-slot and identified by its channel number (CH1 to CH8).

As they are numbered from left to right, channel ports do not face across their corresponding slots.

Each channel can produce two types of output signals on BNC connectors:

- **OUT 2:** analog signal from the T100 module that you can use as an external modulation source for other devices. For more details, see section *Using the T100 Module as a Modulation Source for External Devices (OUT 2 Output)*, p. 164.
- **OUT 1:** analog signal for constant monitoring of the T100 laser diode current ( $I_{LD}$ ) or output power ( $P_{OUT}$ ).

The scale-factors for the OUT 1 signal are the following (FPGA v.3.00):

- Laser diode current ( $I_{LD}$ ): 10 V / 260.4 mA
- Optical output power ( $P_{OUT}$ ): 10 V / 15 mW

The following procedure explains how to set the OUT 1 analog signal.

**Before Starting** Make sure you have an oscilloscope.

- Procedure**
1. Access the T100 **Unit Setup** menu (see section *Accessing an OSICS Module Setup Menu*, p. 33).
  2. Turn the rotary knob to put the cursor before the **Analog out** menu and press the knob.

The **Analog Out** menu appears and displays the monitoring signal currently active on the OUT1 connector.

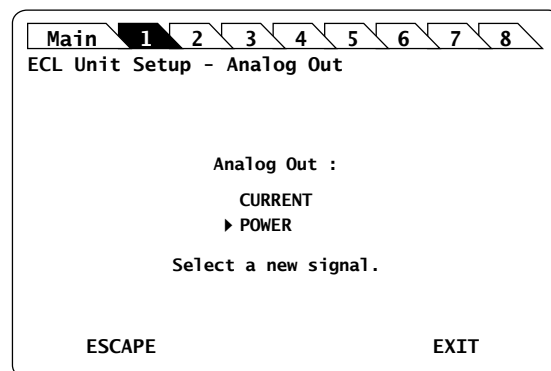

Figure 123: T100 Unit Setup – Analog Out setting

3. Turn the rotary knob to put the cursor before the parameter you want to monitor and press it to validate your selection.

The selected parameter is validated and the T100 **Unit Setup** menu is displayed.

4. To monitor the selected signal, connect your oscilloscope to the **OUT 1** BNC connector corresponding to the channel slot number of the module.

## 12.9 Calibrating the T100 Module

### 12.9.1 Performing a Wavelength Reference Calibration

- Subject** The Wavelength Reference function allows the OSICS T100 to perform its own internal calibration based on a built-in mechanical reference.
- Procedure**
1. Access the T100 **Unit Setup** menu (see section *Accessing an OSICS Module Setup Menu*, p. 33).
  2. Expand the **Calibration** menu and enter the **Wavelength Reference** sub-menu.  
The **Wavelength reference** sub-menu appears prompting you to confirm whether you want to run the wavelength reference calibration.
  3. Press the rotary knob to run the wavelength reference calibration.  
The message *Calibrating...* appears. The referencing process may take up to two minutes. Once the calibration is complete, the T100 **Unit Setup** menu is displayed.

### 12.9.2 Performing a Wavelength/Frequency ( $\lambda/f$ ) Calibration

- Subject** In the  **$\lambda/f$  calibration** sub-menu, first the system internally calibrates the T100 module wavelength or frequency (depending on the unit setting) with a mechanical reference (as explained in section *Performing a Wavelength Reference Calibration*, p. 166), then the system enters the two-point wavelength/frequency calibration sequence.  
The purpose of this function is to correct the discrepancies between the wavelength/frequency displayed by OSICS and the wavelength/frequency reading of your reference wavemeter. This calibration is made at two different wavelengths/frequencies using the T100 **Unit Setup** menu.  
The new calibration wavelengths/frequencies sets the new system calibration default.
- Before Starting** Make sure you have a wavemeter.
- Procedure**
1. Connect the optical output of the OSICS T100 module to the wavemeter.
  2. Enable the module optical output (see section *Enabling/Disabling the Light Source of All Modules*, p. 37).
  3. Access the T100 **Unit Setup** menu (see section *Accessing an OSICS Module Setup Menu*, p. 33).
  4. Expand the **Calibration** menu and enter the  **$\lambda/f$  calibration** sub-menu.  
The system internally calibrates the T100 module wavelength or frequency with a mechanical reference (as explained in section *Performing a Wavelength Reference Calibration*, p. 166).  
The **Wavelength/Frequency calibration** sub-menu appears, showing the first wavelength/frequency value.

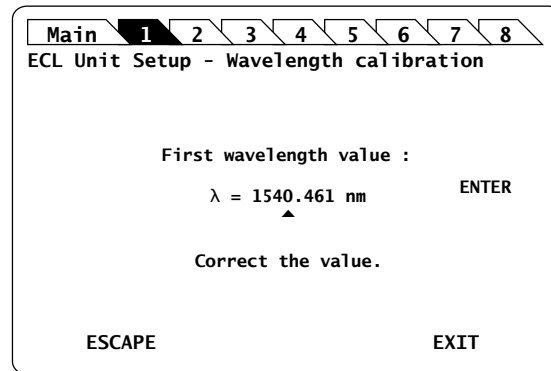

Figure 124: T100 Unit Setup –  $\lambda/f$  calibration, first wavelength

This is the first step of the two-point wavelength/frequency calibration method. The first wavelength/frequency is the first factory calibration wavelength/frequency. The value you enter in this field is the wavemeter reading.

5. Enter the value measured at the wavemeter as follows:
  - a. Turn the rotary knob to put the cursor under the digit you want to modify and press the knob to highlight it.
  - b. Turn the knob clockwise to increase the value or anticlockwise to decrease it and press the knob to validate the selected digit.
  - c. Perform steps a. and b. again with the other digits to modify.
  - d. Turn the rotary knob clockwise to put the cursor under **ENTER** and press the knob to validate the value.

The message `Moving...` appears while the first wavelength/frequency is being set.

The **Wavelength/Frequency calibration** window appears, showing the second wavelength value.

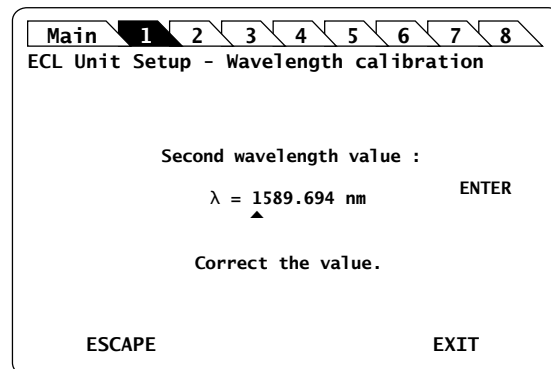

Figure 125: T100 Unit Setup –  $\lambda/f$  calibration, second wavelength

This is the second step of the two-point wavelength/frequency calibration method.

6. Measure the second wavelength/frequency using the wavemeter.
7. Enter the wavelength/frequency reading in this field and select **ENTER**.  
A confirmation message appears.
8. Press the knob to confirm.

While updating the emission wavelength/frequency, the system displays the `Moving...` message until the wavelength/frequency is set.

Once both calibration points are entered, the new calibration values are implemented immediately and stored in the system's flash-memory, and the current wavelength/frequency setting of the T100 module is updated to match the new calibration data. The new calibration wavelengths/frequencies sets the new system calibration default.

The T100 **Unit Setup** menu is displayed.

### 12.9.3 Performing a Power Calibration

**Subject** This section explains how to perform a two-point power calibration sequence using the **Power calibration** function. The purpose of this calibration is to correct the discrepancies between the power displayed by the OSICS T100 module and the power measured at your reference power meter. Also, calibration is made at two different wavelengths to account for small wavelength-dependence of the power meter. The new calibration data sets the new system calibration default.

**Before Starting** Make sure you have a power meter.

**Procedure**

1. Set the T100 output power to **1 mW**.
2. Connect the optical output of the OSICS T100 module to a power meter.
3. Enable the module optical output (see section *Enabling/Disabling the Light Source of the Module*, p. 145).
4. Access the T100 **Unit Setup** menu (see section *Accessing an OSICS Module Setup Menu*, p. 33).
5. Expand the **Calibration** menu and enter the **Power calibration** sub-menu.

The message `Moving...` appears, and the **Power calibration** sub-menu appears, prompting you to set the power at the first wavelength value.

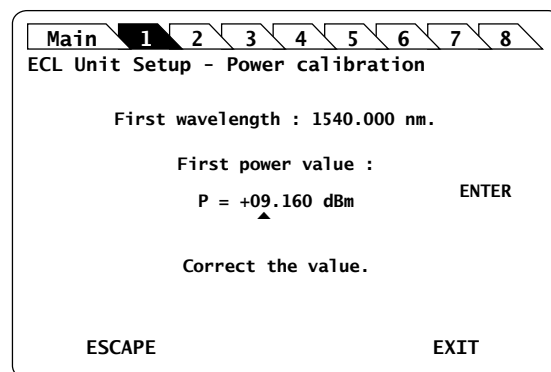

Figure 126: T100 Unit Setup – Power calibration, power value at first wavelength

6. Measure the power level at the first wavelength on the power meter. A valid power value can range from 0.6 mW to 1.2 mW.
7. Enter the power value measured by the power meter and select **ENTER**. The message `Moving...` appears while the power value is set. The **Power calibration** window appears, showing the second window. The T100 tunable laser



moves to a second wavelength in the tuning range and displays the power level corresponding to the calibration data.

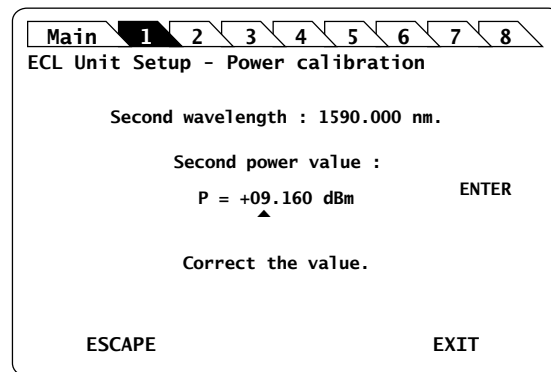

Figure 127: T100 Unit Setup – Power calibration, power value at second wavelength

8. Measure the power level at the second wavelength on the power meter.  
A valid power value can range from 0.6 mW to 1.2 mW.
9. Enter the power value measured by the power meter in this field and select **ENTER**.  
A confirmation message appears.
10. Press the knob to confirm.  
The message *Moving...* appears while the power value is set. The power calibration is now complete and the values are stored in the module's non-volatile memory.  
The T100 **Unit Setup** menu is displayed.  
The new calibration data sets the new system calibration default.

## 12.9.4 Asking for a Factory Recalibration

<b>Subject</b>	To externally verify the performance of the OSICS, refer to the procedure described in section <i>Performing a Wavelength Reference Calibration, p. 166</i> and section <i>Performing a Power Calibration, p. 168</i> . If the performance does not meet warranted specifications, a complete calibration of the instrument may be required. We recommend performing factory calibration of OSICS T100 modules over one-year intervals.
<b>Procedure</b>	Contact the EXFO customer support service (see section <i>Contact Information, p. 4</i> ) for a complete calibration, as some calibration steps require the adjustment of internal components including the laser head.

## 12.10 Testing the Performance of the T100 Module

Use the procedures described in this section to validate warranted specifications of the OSICS T100 module, as needed.

During the performance verification, the settings for wavelength and power may not agree with the measured values. If this occurs, you may calibrate wavelength and power settings as explained in section *Performing a Wavelength/Frequency ( $\lambda/f$ ) Calibration*, p. 166 and section *Performing a Power Calibration*, p. 168.

Notwithstanding performance tests described in this section, we recommend performing calibration of OSICS T100 modules over one-year intervals (see section *Asking for a Factory Recalibration*, p. 169).

### 12.10.1 Preparing Performance Tests

#### Before Starting

Make sure you have the following required equipment for conducting performance tests on OSICS T100 modules:

Equipment	Minimum Requirement
Optical power meter	Wavelength range: 1260 nm to 1680 nm
Optical spectrum analyzer (OSA)	Wavelength range: 1260 nm to 1680 nm
Wavemeter	Wavelength range: 1260 nm to 1680 nm
Jumper (x2)	FC/APC to FC/PC or to FC/APC
In-line optical adapter	FC to FC

The various types as well as the number of fiber-optic connectors needed may vary depending on the type of equipment used and the distance between the test equipment and the OSICS T100 modular optical source under test.



#### Warning

- Disable the laser output before connecting or disconnecting a fiber optic cable on the module (see section *Enabling/Disabling the Light Source of All Modules*, p. 37).
- Do not look directly into the fiber end of an optical cable connected to any optical output while the device is in use. This may cause permanent eye damage.

#### Procedure

1. In the OSICS Mainframe, install the T100 modules you want to test.
2. Turn-on the OSICS multifunction platform (see section *Turning on the OSICS Multifunction Platform and Accessing the System Status Screen*, p. 29).
3. Let the OSICS multifunction platform and other test equipments run continuously for 2 hours at room temperature (within the specified operating temperature range) to achieve proper equipment warm-up.

## 12.10.2 Measuring the Absolute Wavelength Accuracy

<b>Subject</b>	This test procedure enables you to verify that the actual measured wavelength stays within acceptable deviation range from the wavelength setting.
<b>Before Starting</b>	<ul style="list-style-type: none"> <li>Make sure you have a wavemeter with <math>\pm 1</math> pm resolution and a NIST-traceable calibration (see section <i>Preparing Performance Tests</i>, p. 170) and jumper.</li> </ul>
<b>Procedure</b>	<ol style="list-style-type: none"> <li>Connect the OSICS T100 module to the wavemeter.</li> <li>Set the OSICS T100 output power to 0 dBm.</li> <li>Set the wavelength of the OSICS T100 tunable laser to the minimum value of the wavelength range. The minimum wavelength depends on the T100 model you are using (see section <i>Specifying the Optical Emission Wavelength/Frequency</i>, p. 148).</li> <li>Set the wavelength step to +5 nm.</li> <li>Enable the laser output by pressing the <b>Enable</b> button on the module front panel.</li> <li>Compute the wavelength deviation of the T100 module and check that it is not greater than <math>\pm 0.2</math> nm compared with the wavelength reading of the wavemeter. The absolute wavelength accuracy is the deviation between the wavelength setting and the wavelength reading provided by the wavemeter at each measurement step.</li> <li>Increment the T100 wavelength setting one wavelength step (+5 nm) and repeat measurement step 6. to check that the wavelength deviation is not greater than <math>\pm 0.2</math> nm.</li> <li>Stop when you reach the T100 maximum wavelength limit. If the minimum and maximum wavelength limits do not meet the specifications, you can calibrate these values as explained in section <i>Performing a Wavelength/Frequency (<math>\lambda/f</math>) Calibration</i>, p. 166.</li> </ol>

## 12.10.3 Checking the Wavelength Range and Output Power

<b>Subject</b>	This procedure enables you to verify that the T100 module can achieve the rated output power at both ends of the T100 wavelength range.
<b>Before Starting</b>	Make sure you have a powermeter with a NIST-traceable calibration (see section <i>Preparing Performance Tests</i> , p. 170) and jumper.
<b>Procedure</b>	<ol style="list-style-type: none"> <li>Disable the T100 laser output.</li> <li>Connect the T100 laser output to the optical power meter.</li> <li>From the T100 <b>Unit Setup</b> menu, set the wavelength of the T100 tunable laser to the minimum wavelength that corresponds to the type and power option of the T100 module you are using (see <i>OSICS T100 Technical Specifications</i>).</li> <li>Enable the T100 module laser output by pressing the <b>Enable</b> button.</li> </ol>

5. Set the output power value to the rated output power, as given in section *OSICS T100 Technical Specifications* and check that the T100 module can deliver the desired output power at the given wavelength.
6. Set the wavelength of the T100 tunable laser to the maximum wavelength that corresponds to the type and power option of the T100 module you are using (see section *OSICS T100 Technical Specifications*) and check that the T100 module can deliver the desired output power at the given wavelength.
7. Do one of the following, depending on the measured values:
  - If the T100 power settings show small discrepancies compared to the measured powers, perform a two-point manual calibration of the T100 output power (see section *Performing a Power Calibration*, p. 168).
  - If either of the rated output power at the wavelength range ends cannot be achieved, the T100 module requires servicing. Please contact your EXFO customer support service (see section *Contact Information*, p. 4) immediately.

## 12.10.4 Validating the Side Mode Suppression

<b>Subject</b>	This procedure enables you to verify the suppression of any wave emissions that are more than 1 nm away from the selected wavelength.
<b>Before Starting</b>	Make sure you have an appropriate optical spectrum analyzer (see section <i>Preparing Performance Tests</i> , p. 170) and jumper.
<b>Procedure</b>	<ol style="list-style-type: none"> <li>1. Disable the T100 laser output.</li> <li>2. Connect the T100 laser output to the optical spectrum analyzer.</li> <li>3. Set the wavelength of the T100 module to a value at mid-range of the wavelength range as set in the T100 module specifications (see <i>OSICS T100 Technical Specifications</i>).</li> <li>4. Set the T100 laser output power to 0 dBm.</li> <li>5. Configure the optical spectrum analyzer as follows:           <ul style="list-style-type: none"> <li>• Center wavelength: same as T100 laser wavelength setting</li> <li>• Span: 20 nm</li> <li>• Resolution: 0.1 nm</li> <li>• Reference level: 0 dBm</li> <li>• Level scale: 10 dB/div</li> <li>• Scan: Repeat</li> </ul> </li> <li>6. Enable the T100 module laser output by pressing the <b>Enable</b> button.</li> <li>7. Check that, at wavelength deviations larger than 1 nm away from the center wavelength of the laser peak, the power level of any residual emission is lower than -45 dB down from the peak level.</li> </ol>

## 13. Performing Basic Maintenance Operations

User maintenance of the OSICS multifunction platform is limited to basic maintenance tasks that do not require removing the instrument case-cover or accessing any internal component of the instrument.



### Warning

To avoid personal injury, never remove the protective cover of the chassis to perform servicing or maintenance operations. You must refer to your EXFO service representative.

### 13.1 Cleaning the OSICS Multifunction Platform

#### Subject

If the external cover of the OSICS multifunction platform becomes dirty or dusty, clean it by following the instruction below.



### Caution

Do not use chemically active or abrasive materials to clean the OSICS multifunction platform.

#### Before Starting

Material needed: cleaning cloth slightly dampened with an isopropyl alcohol liquid.

#### Procedure

1. Turn the OSICS Mainframe off (see section *Turning Off the OSICS Multifunction Platform*, p. 36) and unplug the power supply cable from the wall socket.
2. Gently swipe dirt and dust on the external cover of the OSICS multifunction platform, without applying excessive force onto it.

## 13.2 Cleaning Optical Connectors

### Subject

To ensure measurement accuracy and prevent loss of optical power, you must verify that optical connectors are clean every time you connect a fiber.

Handle optical fiber with appropriate care and preserve the integrity of optical connectors by keeping them free of contamination.



#### Important

To reduce the need for cleaning, immediately replace protective caps on the optical connectors when not in use.

### Before Starting

Make sure you have the following material:

- Optical grade cleaning cotton swabs
- Clean compressed air
- Isopropyl alcohol



#### Important

Use only high quality cleaning supplies that are non-abrasive and leave no residue.

### Procedure

1. Turn the OSICS Mainframe off (see section *Turning Off the OSICS Multifunction Platform*, p. 36) and unplug the power supply cable from the wall socket.
2. Gently clean the connector end, with the following instructions:
  - a. Hold the can of compressed air upright and spray the can into the air to purge any propellant.
  - b. Spray the clean compressed air on the connector to remove any loose particles or moisture.
  - c. Moisten a clean optical swab with isopropyl alcohol and lightly wipe the surfaces of the connector with gentle circular motion.
  - d. Spray the clean compressed air on the connector again to remove any loose particles or isopropyl alcohol.
  - e. Check that the connector is clean with a fiberscope (or similar).

## 13.3 Replacing the Line Fuses

### Before Starting

- Unplug the power cable.
- Make sure you have the following material:
  - Appropriate power fuse (see section *OSICS Mainframe Technical Specifications*, p. 16).



### Warning

To avoid fire hazard, only use the correct fuse type, voltage and current ratings (see section *OSICS Mainframe Technical Specifications*, p. 16).

- Small flat-blade screwdriver.

### Procedure

1. On the OSICS Mainframe rear panel (see *Figure 2*, p. 18), insert a small flat-blade screwdriver into the notch just below the fuse holder.

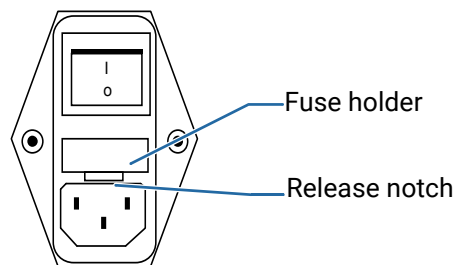

2. Use the notch to pull the fuse holder straight out to remove the fuses.
3. Replace the defective fuse in the fuse holder and snap the fuse holder back into its housing.

## 13.4 Packaging for Shipment

If you need to return the OSICS Mainframe or an OSICS module to EXFO for servicing or factory calibration, use the original packaging.

For instructions on returning the OSICS, please contact EXFO (see section *Contact Information*, p. 4).





## 14. Troubleshooting

Error messages displayed on screen can be generated by the OSICS Mainframe and by any module installed in the OSICS Mainframe.

### 14.1 OSICS Mainframe Error and Warning Messages

This section describes error and warning messages that can be generated by the OSICS Mainframe.

Message	Possible Cause	Possible Resolution
Infinite Wait error(10)	The module is constantly busy. The OSICS Mainframe can no longer communicate with modules.	Reset the system as follows: <ol style="list-style-type: none"><li>1. Turn off the OSICS Mainframe power by pressing the on/off button located on the front panel.</li><li>2. Turn on the OSICS Mainframe by pressing the on/off button again and wait until the <i>Initializing...</i> sequence is complete.</li><li>3. Enter the password and check for any error message.</li></ol> If this error message appears again, please contact the EXFO customer support service (see section <i>Contact Information</i> , p. 4).
Infinite Wait error(20)	The OSICS Mainframe cannot send data to modules.	
Infinite Wait error(30)	The OSICS Mainframe can no longer get any response from modules.	

## 14.2 OSICS Modules Error and Warning Messages

This section describes error and warning messages that can be generated by the OSICS modules.

Module	Message	Possible Cause	Possible Resolution
T100 DFB	User error	User-defined stored configuration data is corrupted or cannot be retrieved.	Turn off and on the OSICS multifunction platform to reset the OSICS module. If this error message appears again, please contact the EXFO customer support service (see section <i>Contact Information</i> , p. 4).
T100 DFB	Fact. error	The factory-set calibration data is corrupted or cannot be retrieved.	Turn off and on the OSICS multifunction platform to reset the OSICS module. If this error message appears again, please contact the EXFO customer support service (see section <i>Contact Information</i> , p. 4).
T100	Moving timeout	The maximum time for the system to try moving the module internal mechanical components has been reached.	Turn off and on the OSICS multifunction platform to reset the module.
T100	Switch error	Mechanical problem. The protection actuator has been triggered.	Perform an internal referencing of the module as described in section <i>Performing a Wavelength Reference Calibration</i> , p. 166. If this error message appears again, please contact the EXFO customer support service (see section <i>Contact Information</i> , p. 4).
T100	Reference error	The module internal wavelength referencing operation has failed.	Turn off and on the OSICS multifunction platform to reset the module.
T100 DFB	LIM	The maximum diode current has been reached. The desired power setting cannot be achieved and the system no longer operates at constant power.	Try to change the power setting and/or the operating wavelength to a value that yields a permissible diode current level.
DFB	ERROR T	Temperature control error	Try to change the operating wavelength. Turn off and on the OSICS multifunction platform.

# Certification and Compliance

## Regulatory Information

### Canada and USA Electromagnetic Interference Regulatory Statement

Electronic test and measurement equipment is exempt from FCC part 15, subpart B compliance in the United States of America and from ICES-003 compliance in Canada. However, EXFO Inc. makes reasonable efforts to ensure compliance to the applicable standards.

The limits set by these standards are designed to provide reasonable protection against harmful interference when the equipment is operated in a commercial environment. This equipment generates, uses, and can radiate radio frequency energy and, if not installed and used in accordance with the user guide, may cause harmful interference to radio communications. Operation of this equipment in a residential area is likely to cause harmful interference in which case the user will be required to correct the interference at his own expense.

Modifications not expressly approved by the manufacturer could void the user's authority to operate the equipment.

### European Electromagnetic Compatibility Regulatory Statement

Warning: This is a class A product. In a domestic environment, this product may cause radio interference in which case the user may be required to take adequate measures. Your product is compliant with industrial electromagnetic environments.

### European Declaration of Conformity

The European Declaration of Conformity is available at [www.EXFO.com/en/resources/legal-documentation](http://www.EXFO.com/en/resources/legal-documentation)

## Recycling and Disposal



This symbol on the product means that you should recycle or dispose of your product (including electric and electronic accessories) properly, in accordance with local regulations. Do not dispose of it in ordinary garbage receptacles.

For complete recycling/disposal procedures and contact information, visit the EXFO website at [www.EXFO.com/recycle](http://www.EXFO.com/recycle).

### China Table of Toxic and Hazardous Substances

CHINESE REGULATION ON RESTRICTION OF HAZARDOUS SUBSTANCES (RoHS)

中国关于有害物质限制的规定

NAMES AND CONTENTS OF THE TOXIC OR HAZARDOUS SUBSTANCES OR ELEMENTS CONTAINED IN THIS EXFO PRODUCT

包含在本 EXFO 产品中的有毒有害物质或元素的名称及含量

Part Name 部件名称	Lead 铅 (Pb)	Mercury 汞 (Hg)	Cadmium 镉 (Cd)	Hexavalent Chromium 六价铬 (Cr(VI))	Polybrominated biphenyls 多溴联苯 (PBB)	Polybrominated diphenyl ethers 多溴二苯醚 (PBDE)
Enclosure 外壳	0	0	0	0	0	0
Electronic and electrical sub-assembly 电子和电气组 件	X	0	X	0	X	X
Optical sub-assembly <sup>a</sup> 光学组件 <sup>a</sup>	X	0	0	0	0	0
Mechanical sub-assembly <sup>a</sup> 机械组件 <sup>a</sup>	0	0	0	0	0	0

Note:

注：

This table is prepared in accordance with the provisions of SJ/T 11364.

本表依据 SJ/T 11364 的规定编制。

O: Indicates that said hazardous substance contained in all of the homogeneous materials for this part is below the limit requirement of GB/T 26572.

O: 表示该有害物质在该部件所有均质材料中的含量均在 GB/T 26572 标准规定的限量要求以下。

X: indicates that said hazardous substance contained in at least one of the homogeneous materials used for this part is above the limit requirement of GB/T 26572. Due to the limitations in current technologies, parts with the "X" mark cannot eliminate hazardous substances.

X: 表示该有害物质至少在该部件的某一均质材料中的含量超出 GB/T 26572 标准规定的限量要求。



标记“X”的部件，皆因全球技术发展水平限制而无法实现有害物质的替代。

a. If applicable.

如果适用。

#### MARKING REQUIREMENTS

标注要求

Product 产品	Environmental protection uses period (years) 环境保护使用期限 (年)	Logo 标志
This EXFO product 本 EXFO 产品	10	
Battery <sup>a</sup> 电池 <sup>a</sup>	5	

a. If applicable.

如果适用。

## List of Figures

ATN Configuration   <i>Figure 22</i> :	49
ATN Module – Front and Rear Panels   <i>Figure 23</i> :	50
ATN Unit Setup – Adjust Attenuation menu   <i>Figure 25</i> :	53
ATN Unit Setup – Set Attenuation menu   <i>Figure 24</i> :	52
ATN Unit Setup – Set Offset menu   <i>Figure 28</i> :	56
ATN Unit Setup – Set Step sub-menu   <i>Figure 26</i> :	54
ATN Unit Setup – Set Wavelength menu   <i>Figure 27</i> :	55
BKR Unit Setup – Adjust Attenuation menu   <i>Figure 32</i> :	60
BKR Unit Setup – Set Attenuation menu   <i>Figure 31</i> :	59
BKR Unit Setup – Set Offset menu   <i>Figure 35</i> :	63
BKR Unit Setup – Set Step sub-menu   <i>Figure 33</i> :	61
BKR Unit Setup – Set Wavelength menu   <i>Figure 34</i> :	62
BNC OUT1 signal level depending on wavelength (at 2 mW)   <i>Figure 97</i> :	137
DFB Module – Front and Rear Panels   <i>Figure 36</i> :	67
DFB Unit Setup – Adjust Power menu   <i>Figure 38</i> :	71
DFB Unit Setup – Analog Out setting   <i>Figure 61</i> :	91
DFB Unit Setup – Modulation Control (Off)   <i>Figure 55</i> :	84
DFB Unit Setup – Modulation Control (On)   <i>Figure 45</i> :	77
DFB Unit Setup – Modulation Control (On)   <i>Figure 50</i> :	80
DFB Unit Setup – Modulation Control (On)   <i>Figure 53</i> :	82
DFB Unit Setup – Modulation Source (Internal)   <i>Figure 43</i> :	75
DFB Unit Setup – Modulation Source (Mainframe)   <i>Figure 49</i> :	79
DFB Unit Setup – Modulation Source (Mainframe)   <i>Figure 52</i> :	81
DFB Unit Setup – Power calibration   <i>Figure 63</i> :	93
DFB Unit Setup – Set Frequency   <i>Figure 44</i> :	76
DFB Unit Setup – Set Power menu   <i>Figure 37</i> :	70
DFB Unit Setup – Set Step sub-menu   <i>Figure 40</i> :	73
DFB Unit Setup – Set Wavelength/Frequency menu   <i>Figure 39</i> :	72
DFB Unit Setup – Sinus Modulation (Set Frequency)   <i>Figure 58</i> :	87
DFB Unit Setup – Sinus Modulation (Set Rate)   <i>Figure 59</i> :	88
DFB Unit Setup – Sinus Modulation Control   <i>Figure 60</i> :	89
DFB Unit Setup – Wavelength calibration   <i>Figure 62</i> :	92
Diode current resulting from sinusoidal modulation   <i>Figure 57</i> :	86
External Analog Modulation Setup   <i>Figure 120</i> :	161
External Analog Modulation Setup   <i>Figure 54</i> :	83
Main Setup – Modulation Frequency   <i>Figure 113</i> :	156
Main Setup – Modulation Frequency   <i>Figure 17</i> :	42
Main Setup – Modulation Frequency   <i>Figure 47</i> :	78
Main Setup – Modulation Real Frequency   <i>Figure 114</i> :	157
Main Setup – Modulation Real Frequency   <i>Figure 18</i> :	42
Main Setup – Modulation Real Frequency   <i>Figure 48</i> :	79
Main Setup – Modulation Source (External)   <i>Figure 117</i> :	159
Main Setup – Modulation Source (External)   <i>Figure 19</i> :	43
Main Setup – Modulation Source (External)   <i>Figure 51</i> :	81
Main Setup – Modulation Source (Internal)   <i>Figure 112</i> :	156
Main Setup – Modulation Source (Internal)   <i>Figure 16</i> :	41
Main Setup – Modulation Source (Internal)   <i>Figure 46</i> :	78

Main Setup – New Password   <i>Figure 11</i> :	35
Main Setup – Power reference sub-menu   <i>Figure 13</i> :	39
Main Setup – Save configuration   <i>Figure 20</i> :	47
Main Setup – Save configuration   <i>Figure 21</i> :	48
Main Setup – Set unit dBm/mW sub-menu   <i>Figure 12</i> :	38
Main Setup – Set unit GHz/nm sub-menu   <i>Figure 14</i> :	39
Mainframe – Front Panel   <i>Figure 1</i> :	17
Mainframe – Rear Panel   <i>Figure 2</i> :	18
Mainframe and DFB Module Modulation Scheme   <i>Figure 41</i> :	74
Mainframe and T100 Module Modulation Scheme   <i>Figure 107</i> :	152
Mainframe Modulation Scheme   <i>Figure 15</i> :	40
Module Installation – Module Insertion   <i>Figure 5</i> :	24
Module Installation – Module Removal   <i>Figure 6</i> :	25
Module Installation – Plate Removal   <i>Figure 4</i> :	24
OSICS BKR Module – Front and Rear Panels   <i>Figure 30</i> :	58
OSICS BKR Principle   <i>Figure 29</i> :	57
Password Screen   <i>Figure 8</i> :	29
Remote Interlock pin assignment   <i>Figure 7</i> :	27
Resulting Diode Current with External Analog Modulation Source   <i>Figure 122</i> :	163
Resulting Diode Current with External Analog Modulation Source   <i>Figure 56</i> :	85
Retractable Legs   <i>Figure 3</i> :	21
Setup Menu – Examples   <i>Figure 10</i> :	33
SLD Module – Front and Rear Panels   <i>Figure 64</i> :	100
SLD Unit Setup – Set Power menu   <i>Figure 65</i> :	103
SWT APC Implementation Example – Sequential Testing of Two or Four Devices   <i>Figure 82</i> :	118
SWT APC Implementation Example – Testing a DUT over a Wide Spectrum   <i>Figure 84</i> :	119
SWT APC Implementation Example – Testing of an Optical Amplifier   <i>Figure 83</i> :	119
SWT APC Implementation Example – Two Laser Sources and a Wavemeter   <i>Figure 81</i> :	118
SWT APC in T100 Full-Band Configuration   <i>Figure 80</i> :	118
SWT APC Module – Front and Rear Panels   <i>Figure 85</i> :	121
SWT APC Performance Test – Crosstalk   <i>Figure 99</i> :	140
SWT APC Performance Test – Repeatability   <i>Figure 98</i> :	139
SWT APC Reverse Configuration   <i>Figure 79</i> :	117
SWT APC Setup – Channel Configuration menu (1x4 Example Screen)   <i>Figure 87</i> :	125
SWT APC Setup – Channel Configuration menu (1x4 Example Screen)   <i>Figure 88</i> :	126
SWT APC Standard Configuration   <i>Figure 78</i> :	117
SWT APC Unit Setup – Auto peak find menu   <i>Figure 94</i> :	134
SWT APC Unit Setup – Channel Selection menu (SWT APC 1x4 Example Screen)   <i>Figure 86</i> :	123
SWT APC Unit Setup – Coherence Control menu   <i>Figure 93</i> :	133
SWT APC Unit Setup – Modulation Control (On)   <i>Figure 96</i> :	136
SWT APC Unit Setup – Modulation Source   <i>Figure 95</i> :	135
SWT APC Unit Setup – Scan Control sub-menu   <i>Figure 92</i> :	132
SWT APC Unit Setup – Set Power menu   <i>Figure 89</i> :	128
SWT APC Unit Setup – Set Step sub-menu   <i>Figure 91</i> :	130
SWT APC Unit Setup – Set Wavelength/Frequency menu   <i>Figure 90</i> :	129
SWT Implementation Example – Sequential Testing of Two or Four Devices   <i>Figure 69</i> :	106
SWT Implementation Example – Testing of an Optical Amplifier   <i>Figure 70</i> :	106
SWT Implementation Example – Two Laser Sources and a Wavemeter   <i>Figure 68</i> :	106
SWT Module – Front and Rear Panels   <i>Figure 71</i> :	108
SWT Performance Test – Crosstalk   <i>Figure 77</i> :	116
SWT Performance Test – Repeatability   <i>Figure 76</i> :	115
SWT Reverse Configuration   <i>Figure 67</i> :	105
SWT Standard Configuration   <i>Figure 66</i> :	105
SWT Unit Setup – Channel Selection menu (SWT 1x4 Example Screen)   <i>Figure 72</i> :	110

---

SWT Unit Setup – Sequence Switching - Control   <i>Figure 75</i> : .....	113
SWT Unit Setup – Sequence Switching - Number of Scans   <i>Figure 73</i> : .....	111
SWT Unit Setup – Sequence Switching - Set delay (SWT 1x4 Example Screen)   <i>Figure 74</i> : .....	112
System Status Screen   <i>Figure 9</i> : .....	30
T100 Module – Front and Rear Panels   <i>Figure 100</i> : .....	143
T100 Unit Setup – Adjust Power menu   <i>Figure 102</i> : .....	147
T100 Unit Setup – Analog Out setting   <i>Figure 123</i> : .....	165
T100 Unit Setup – Auto peak find menu   <i>Figure 106</i> : .....	151
T100 Unit Setup – Coherence Control menu   <i>Figure 105</i> : .....	150
T100 Unit Setup – Modulation Control (Off)   <i>Figure 121</i> : .....	162
T100 Unit Setup – Modulation Control (On)   <i>Figure 111</i> : .....	155
T100 Unit Setup – Modulation Control (On)   <i>Figure 116</i> : .....	158
T100 Unit Setup – Modulation Control (On)   <i>Figure 119</i> : .....	160
T100 Unit Setup – Modulation Source (Internal)   <i>Figure 109</i> : .....	153
T100 Unit Setup – Modulation Source (Mainframe)   <i>Figure 115</i> : .....	157
T100 Unit Setup – Modulation Source (Mainframe)   <i>Figure 118</i> : .....	159
T100 Unit Setup – Power calibration, power value at first wavelength   <i>Figure 126</i> : .....	168
T100 Unit Setup – Power calibration, power value at second wavelength   <i>Figure 127</i> : .....	169
T100 Unit Setup – Set Frequency   <i>Figure 110</i> : .....	154
T100 Unit Setup – Set Power menu   <i>Figure 101</i> : .....	146
T100 Unit Setup – Set Step sub-menu   <i>Figure 104</i> : .....	149
T100 Unit Setup – Set Wavelength/Frequency menu   <i>Figure 103</i> : .....	148
T100 Unit Setup – $\lambda/f$ calibration, first wavelength   <i>Figure 124</i> : .....	167
T100 Unit Setup – $\lambda/f$ calibration, second wavelength   <i>Figure 125</i> : .....	167
TTL-Modulated Output Power Signal (DFB Module)   <i>Figure 42</i> : .....	75
TTL-Modulated Output Power Signal (T100 Module)   <i>Figure 108</i> : .....	153

